

# BRITEC

Let all the circuits  
get surge protected

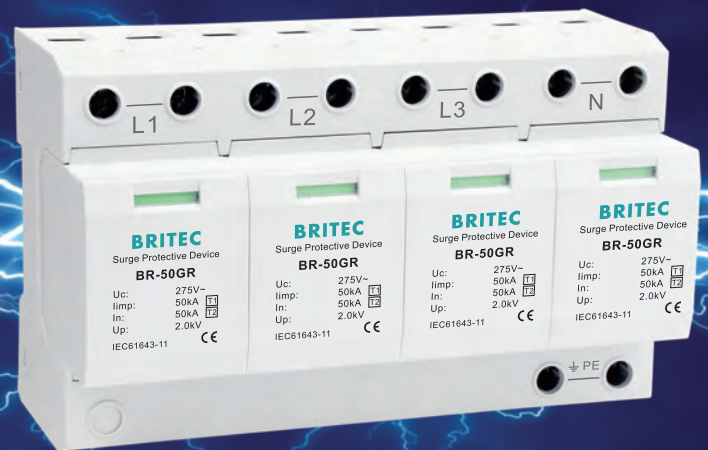

## Product Catalogue

**Britec Electric Co., Ltd.**

[www.britecelectric.com](http://www.britecelectric.com)



## Company Profile

Britec Electric specializes in research and development of surge protection devices. With more than 20 years experiences, we offer the market with a new choice of Type 1, Type 2 and Type 3, PV SPDs as well as SPDs for data protection.

Our SPDs are uniquely designed and patented which is more safe, higher capacity in smaller size etc. Our products are made under IEC standard and are 100% tested before leaving factory. Products are certified by Intertek SEMKO, TUV and CB. Our in house laboratory can do most of tests under IEC61643-11 and IEC61643-31.

Our technical department can develop products according to customer's requirements. We can make the tooling in 45 days. If you have special products needs OEM, we are your ideal partner.

Fully understand the ISO9001 quality management system, the company strictly control the supplier and materials for production, the assembly process is standardized and the final checking to be done automatically.

With strict quality control, our products can compete with top brands in the market. We are looking for agents and distributors for our products and is willing to accept OEM orders for customers with quality first mentality.

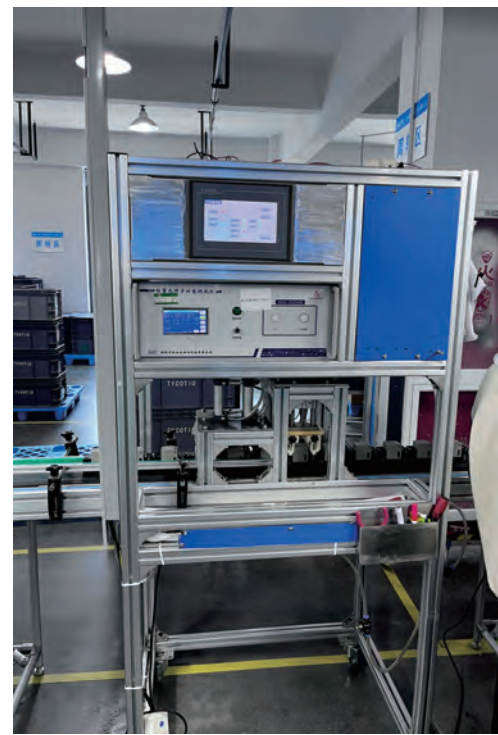

# Contents

Type 1 Surge Arrester	10
Type 1+2 Surge Arrester	29
Type 2 Surge Arrester	42
Type 2+3 Surge Arrester	81
Type 3 Surge Arrester	84
LED Lightning Protector	86
DC Surge Arrester For PV	98
SPD For Data Protection	109
SCB, Surge Counter etc.	122



Britec Electric Co., Ltd.

ISO9001





# Basic Knowledge of Lightning Protection

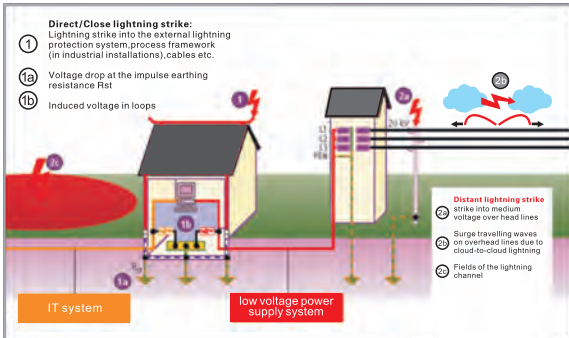

Fig. 1

## Lightning Protection Zone

Failures of technical systems and installations cause trouble and economic losses. These require faultless operation from the equipment both under “normal” conditions and in case of thunderstorms.

Loss reports of insurance companies show clearly that nearly a quarter of the private damage and 45% of commercial damage are due to surge. A comprehensive protection concept would help to eliminate the damage from the surge.

The Lightning Protection Zones Concept enables designers, constructors and operators to plan, perform and control protection measures. All relevant devices, installations and systems are thus reliably protected with economically acceptable efforts.

## Sources of interference

Surges arising due to thunderstorms are caused by direct or close lightning strokes or distant lightning strokes (Fig. 1).

Direct or close lightning strokes are strokes into the lightning protection system of a structure, into its immediate surroundings or into the conductive systems entering the structure (e.g. low-voltage power supply, telecommunications lines and control lines...).

Due to their amplitudes and energy loads, the arising impulse currents and impulse voltages as well as the corresponding electromagnetic field (LEMP) represent a special risk for the system.

In case of a close or direct lightning strike, the surges (Fig. 1: Case 1.1) are caused by a voltage drop at the impulse earthing resistance and the resulting potential rise of the structure towards the distant surroundings. This is the maximum load on electrical installations in structures.

The characteristic parameters of flowing impulse currents (peak value, rate of current rise, load, specific energy) can be described with the impulse-current wave form 10/350  $\mu$ s (Fig. 2) and are defined in international, European and national standards as test currents for components and devices for protection against direct lightning strokes. In addition to the voltage drop at the impulse earthing resistance, surges arise in the electrical building installation and the systems connected to it and equipment due to the induction effect of the electromagnetic lightning field (Fig 1: Case 1.2).

The power of these induced surges and the resulting impulse currents is considerably lower than the power of a direct lightning impulse current and is therefore only described with the impulse current wave 8/20  $\mu$ s (Fig. 2).

Components and equipment, which do not have to conduct currents from direct lightning strokes, are therefore tested with impulse currents of 8/20  $\mu$ s.

## Protection philosophy

Distant strokes are lightning strokes from a distance to the object to be protected, lightning strokes into the medium voltage overhead line network or into its immediate surroundings or lightning discharges from cloud to cloud (Fig. 1: Cases 2.1, 2.2 and 2.3).

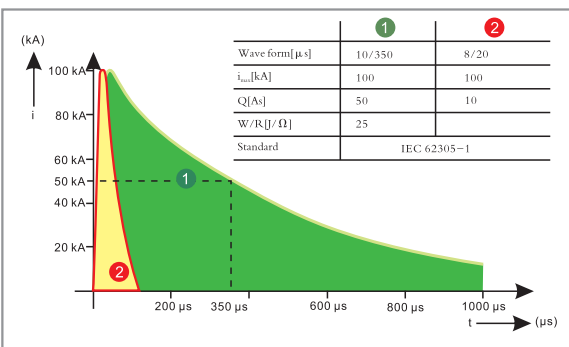
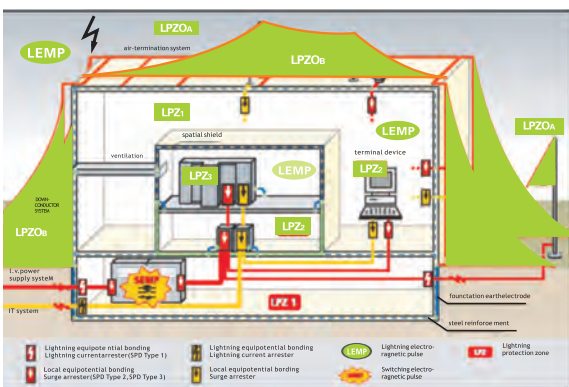

Fig. 2



LEMP

In analogy to induced surges, the effects of distant lightning strokes on the electrical system of a structure are controlled by devices and components, which are designed accordingly for impulse current wave 8/20  $\mu$ s.

Surges due to switching operations (SEMP) are caused by e.g. switching off inductive load (e.g. transformers, coils, motors), ignition and interruption of electric arcs (e.g. arc welding device), tripping of fuses.

The effects of switching operations in electrical installations of structures can also be simulated with impulse currents of wave form 8/20  $\mu$ s for testing purposes.

## LEMP protection of structures with electrical and electronic systems according to IEC 62305-4

Lightning Protection Zone	Description
LPZ 0A	Threat by direct lightning strokes, impulse currents up to complete lightning currents and the entire lightning field.
LPZ 0B	Protected against direct lightning strokes. Threat by impulse currents up to partial lightning currents and the entire lightning field.
LPZ 1	Impulse currents are further limited by current distribution and SPDs situated at the zone boundaries. The lightning field is mostly attenuated by spatial shielding.
LPZ 2	Impulse currents are further limited by current distribution and SPDs situated at the zone boundaries. The lightning field is mostly attenuated by spatial shielding.

### SPD for Different Power Distribution Systems:

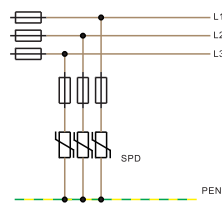

SPD in TN-C system

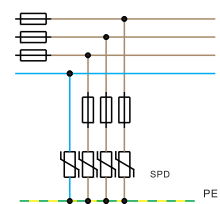

SPD in TN-S system

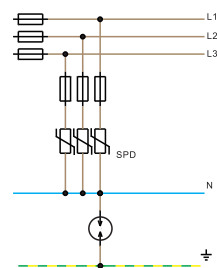

SPD in TT system

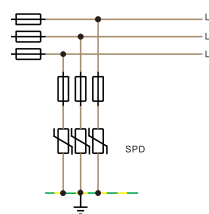

SPD in IT system



## Type of surge protectors

The AC power surge protectors have 3 categories by IEC 61643-11 and EN 61643-11 standards, with the following 3 classes of tests. These different tests depend on the location of the surge protector in the AC network and on the external conditions.

### Type 1 surge protectors

Type 1 surge protectors are designed to be installed where a direct lightning strike risk is high, especially when the building is equipped with external lightning protection system (LPS or lightning rod). In this situation, EN 61643-11 and IEC 61643-11 standards require the Class I test to be applied to surge protectors : this test is characterized by applying 10/350  $\mu$ s impulse current in order to simulate the direct lightning strike consequence. Therefore these Type 1 surge protectors must be especially powerful to conduct this high energy impulse current.

### Type 2 surge protectors

Type 2 surge protectors are designed to be installed at the entrance of the installation, in the main switchboard, or close to sensitive terminals, on installations without LPS (lightning rods). These protectors are tested following the Class II test from IEC61643-11 or EN61643-11 standards and based on 8/20  $\mu$ s impulse current

### Type 3 surge protectors

In case of very sensitive or remote equipment, secondary stage of surge protectors is required : these low energy SPDs could be Type 2 or Type 3 (see Coordination of surge protector page 8 ). Type 3 SPDs are tested with a combination waveform 1,2/50  $\mu$ s voltage - 8/20  $\mu$ s current following Class III test.

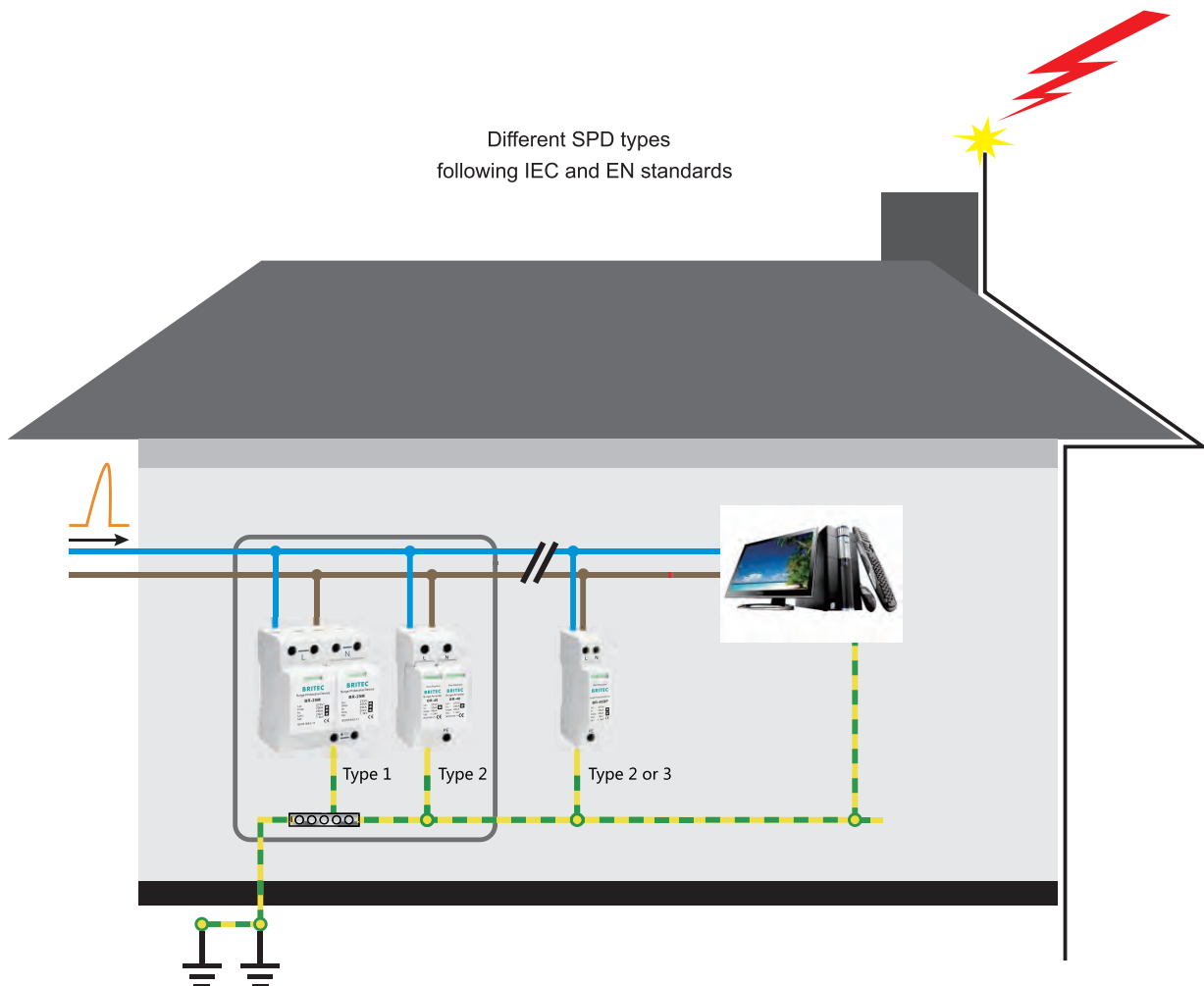

## Maintenance

BR surge protectors are designed for repetitive operation and do not require specific maintenance. Nevertheless, in case of an extreme event, a controlled end of life could occur (see above) and a maintenance operation must be performed .

## Pluggable design

The design of some BR surge protectors (BR-20, BR-40, BR-80 and BR-12.5M) is based on the use of a pluggable module that plugs into a matching base. This makes replacement, and checking very easy without impairing the protection function. On multipolar surge protectors, the possibility of replacing a single pole makes rehabilitating a surge protector less expensive.

## Status Indication

BR surge protectors are equipped with a failure indicator (mechanical or light) linked to the internal thermal disconnecter: in case of safety disconnection, the indicator will switch on and the SPD must be replaced.

## Remote Signaling

Most BR surge protectors are available in remote signaling versions. This feature, which allows remote checking of the status of the surge protector, is especially important when the products are hard to reach or unsupervised.

The system consists of an auxiliary changeover contact that is activated if the surge protector module changes status.

This lets the user monitor :

- the good operation of the SPD
- the presence of the plug-in modules (if any)
- the end of life (disconnection) of the surge protector.

The remote signaling version allows the choice of signaling system appropriate to the installation (light, buzzer, automation, modem transmission...).

## Disconnection devices

In compliance with the standards, the AC power surge protectors are equipped with external and internal disconnection devices in order to provide total safety in case of failure.

2 types of devices are necessary :

**Internal thermal security** which will disconnect the surge protector from the AC network in case of thermal runaway. In such a case, the user will be warned about the trouble by an indicator (mechanical or light) in front of the protector and will carry out the replacement of the defective SPD.

**External electrical disconnecter** (fuses or breaker) to disconnect the surge protector from the AC network in case of internal short circuit, e.g. due to an excessive impulse current. The rating of the external fuses (or breaker) are in relation with the discharge capability of the SPD and the prospective short-circuit current of the installation and must be tested together with the surge protector in order to ensure compliance of the short-circuit current withstand test (Iscpr parameter). To ease the selection of these components, the rating and type of fuses (or breaker) are mentioned in the datasheet and in the installation instructions of each SPD (see Backup Fuses page 4).

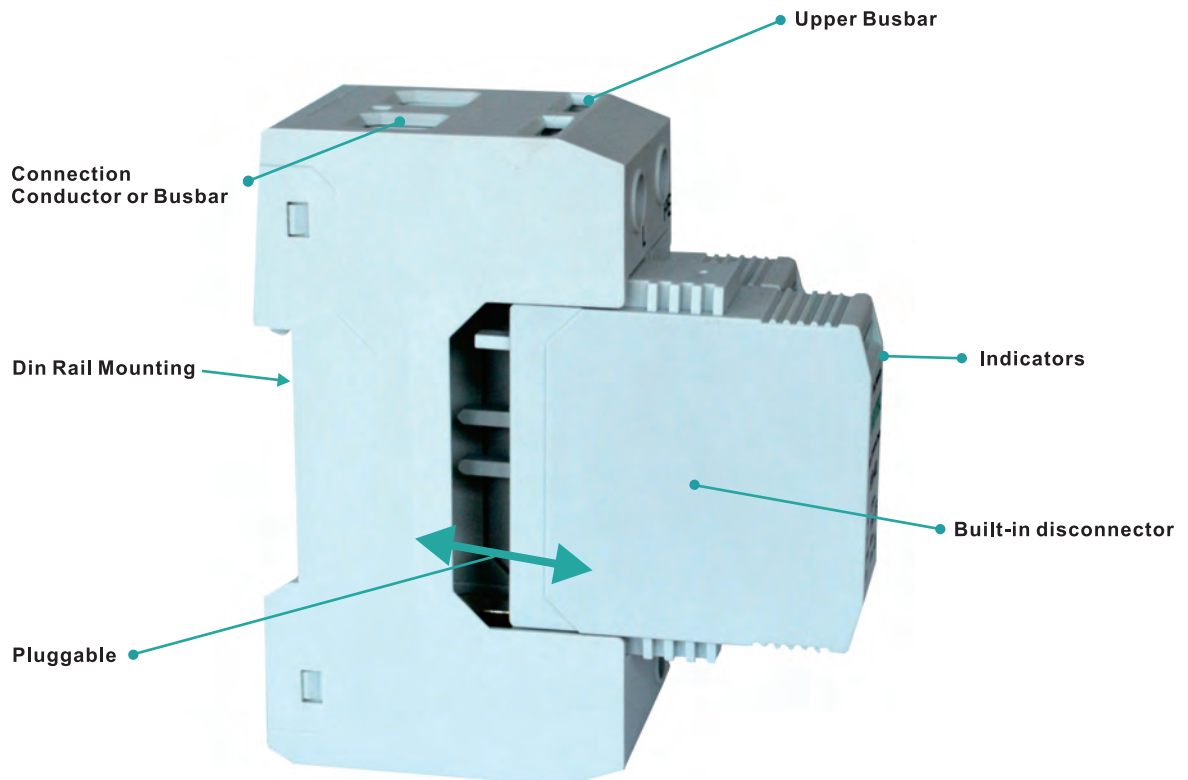



## Surge protection installation

### Installation Location

BR surge protectors are installed as follows, according to their types:

- **Type 1 or Heavy duty:** at the origin of the installation, in a separate box or on the main electrical panel, for efficient discharge of partial lightning currents.
- **Type 2 or Primary:** at the origin of the installation, on the main electrical panel, in order to eliminate impulses currents as fast as possible and thereby avoid coupling.
- **Type 2 (or Type 3) or Secondary:** on the secondary panel, near the sensitive equipment, to limit ringing and improve the level of protection.

### Wiring

Since lightning surges are essentially common-mode phenomena, BR surge protectors are connected mainly in common mode (between the active conductors and ground).

Some recommendations call for additional differential-mode protection (between phase and neutral). For these applications, BRITEC offers specific versions, using a gas tube base module for the Neutral to Ground (differential mode) protection: this type of installation is called a CT2 connection in IEC 60364 standard, is used in surge protectors such as BR-40 3+1.

Common mode protection

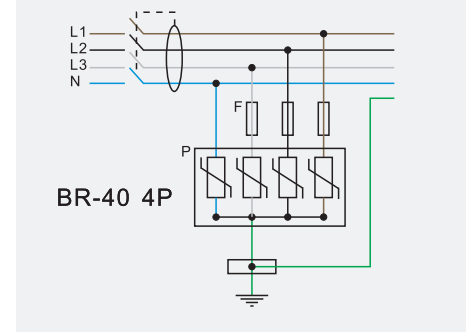

Common and differential mode protection

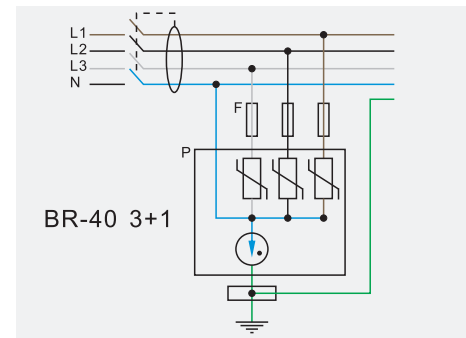

## Backup fuses

To comply with standards and safety, the AC surge protectors must be protected against a possible end of life in short-circuit: the user must install on each SPD branch, a protection against short-circuit current (fuses or breaker).

The rating of this fuses is given by the SPD manufacturer in the product datasheet or installation instructions. The choice of this rating depends of 2 criteria :

- Withstand of the short-circuit current  $I_{sc}$  in the IEC 61643-11 standard: the fuse must cut safety the short-circuit current before an harsh destruction of the SPD.
- Withstand of the discharge currents ( $I_n$  or  $I_{imp}$ ): the fuse must be able to conduct the discharge current of the SPD without blowing.

BRITEC has selected some fuses and DIN rail holders to fit with his SPD range. The fuses equipped with failure indicators to check easily their operating status.

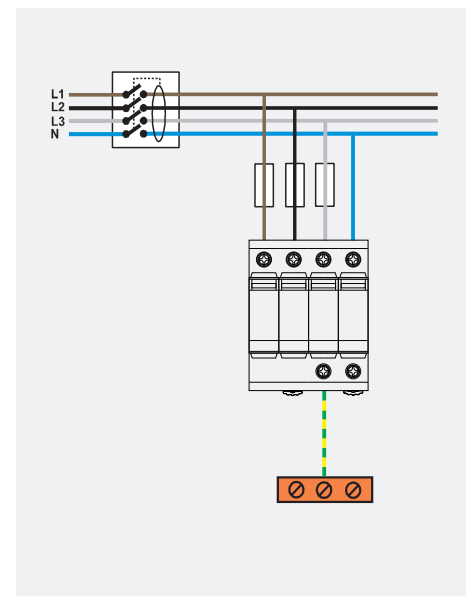



## Installation

BR surge protectors are connected in parallel on the AC network and must be equipped with external fuses (or breakers) for short-circuit protection (see paragraph Backup Fuses).

- The total length of connection wires to AC network must be lower than 0.5 m in order not to increase the protection level(Up) provided by the SPD.
- Wiring is made by screw connections. On some models, a distribution bus can be used.
- The protection wire coming from the SPD must be connected to the bonding bar of the electrical panel. Paralleling the protection wire with phases conductors must be avoided.
- The cross sectional wire must be 6 mm<sup>2</sup> minimum for Type 2 SPD's and 16 mm<sup>2</sup> for Type 1.
- Local earthing resistance must be in compliance with the electrical rules.

Further information can be found in IEC 61643-12 standard (selection and application principles for low voltage SPD).

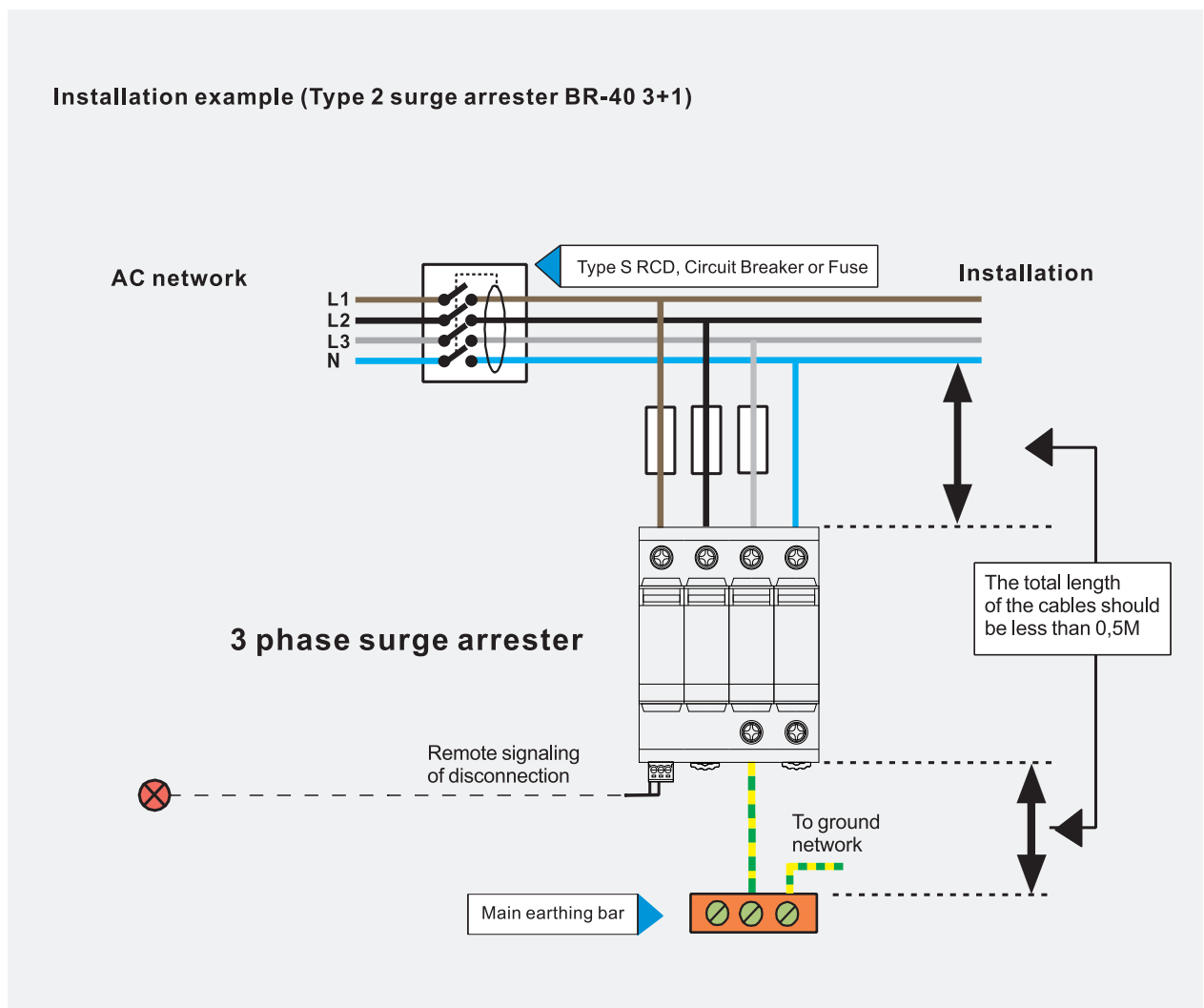



# Choosing Surge Protectors

BRITEC's line of AC power surge protectors is designed to cover all possible configurations in low voltage installations. They are available in many versions, which differ in:

- Type or test class (1, 2 or 3)
- Operating voltage (Uc)
- AC network configuration (Single/3-Phase)
- Discharge currents (Iimp, Imax, In)
- Protection level (Up)
- Protection technology (varistors, VG technology, filter)
- Features (differential mode, plug-in, remote signaling, compact..).

The surge protection selection must be done following the local electrical code requirements (e.g. : minimum rating for In) and specific conditions (e.g. : high lightning density).

## Choosing the Type of surge protectors

The type of surge protector is based on its location and the constraints of the installation to be protected.

ConfigurationSPD	Type	Location	BRITEC
Installation equipped with LPS or could be hit by lightning	Type 1+2 Type 1+2+3	Origin of the installation origin (Panel or main switchboard)	BR-50GR BR-25M BR-12.5M BR-7M
Installation without LPS	Type 2 Type 2+3	main switchboard	BR-80, BR-110 BR-20, BR-40
Secondary protection (downstream primary SPD)	Type 2 (or Type 3)	close to protected equipment	BR-20DP BR-15DP BR275-6

## Choosing the operating voltages Uc and UT

The SPD Uc voltage (maximum continuous operating voltage) depends on:

- Nominal voltage of the AC network (Uo)
- Type of AC system (TN, TT, IT).

The level of resistance to temporary overvoltages (UT) is related to the Uc voltage. In addition, withstanding the "high voltage" TOV (1200 Vac, 300A, 200 ms) between Neutral and PE is needed in TT AC system, which requires the CT2 diagram.

## Operating voltage Uc (Line/Ground)

AC Network	230/400V			120/208V
	TT	TN	IT	TN
Voltage Uc mini	255V	255V	440V	135V
Voltage UT	335/440V	335/440V	-	175/230V
TOV N/PE	1200V			
Example of BRITEC product	BR-40 275TT	BR-40 275	BR-40 440	BR-40 150

## AC network configuration

BR surge protectors are available for single, 3-Phase and 3-Phase + neutral AC networks.

## Choosing Iimp

The impulse current Iimp is defined for Type 1 SPD. The minimum rating for Iimp is 12.5 kA by pole, following IEC 60364-5- 534 . This level is adapted to the real phenomenon. This value can, however, be increased according to the risk (calculation according to EN 62305-1) BRITEC proposes, in its Type 1 SPD range, 3 levels of Iimp current by pole: 12.5, 25 and 50 kA.

Configuration	Iimp/pole	BRITEC
Maximum risk	50 kA	BR-50GR
Very high lightning density Bad earthing	25 kA	BR-25M
High, medium or low lightning density	12.5 kA	BR-12.5GR BR-12.5M

## Choosing In current

The relevant nominal discharge current In for the SPD is in relation with the lightning risk in the installation area.

The minimum rating of In for a SPD connected at the installation entrance is 5 kA (8/20 μs waveform), required by standard.

Nevertheless higher ratings are advised in case of high lightning density. Moreover higher values of In current will increase the SPD lifetime. Imax (max. discharge current) rating is linked to In.

Conditions	In	BRITEC
Very high lightning density	> 20 kA	BR-80
High or medium lightning density	10-20 kA	BR-40 BR-20
Low lightning density or secondary SPD	5 kA	BR-10DP BR275-6

## Choosing the protection level Up

The user must select a surge protector with a protection level Up adapted to the withstand level of terminal equipment. In every case, the lower the protection level Up, the better the protection.

IEC 60364 standard calls for the minimum protection level of 2.5 kV for a SPD connected at the entrance of a 230/400 V network : this level is in compliance with the withstand of robust devices (electromechanical type).

Electronic-based terminals have lower impulse withstand and require a better protection : so, surge protectors with 1.5 kV protection are necessary to provide efficient protection.

Conditions	Recommended Up	
	230/400 V AC network	120/208 V AC network
SPD at the installation entrance	2.5 kV max.	1.5 kV max.
Electromechanical protected equipment	2.5 kV	1.5 kV
Electronic-based protected equipment	1.5 kV	0.8 kV

### Choosing the SPD technology

A relevant choice of the SPD technology, as well as the use of coordination diagram can help to improve the protection level.

BR surge protectors are based on Varistor (MOV) technology.

Some versions use different electrical diagrams in order to improve some of their characteristics :

-VG technology:

this Gas tube-Varistor combined SPD improves the reliability and and the efficiency.

-Multigap sparkgap technology

This kind of surge protector can discharge large impulse current. It can also has a high follow up current due to the product consists by many sparkgaps

Product such as BR-50GR and BR-12.5GR are based on this technology.

This coordination is required in the 2 following cases :

-High sensitivity equipment :

➔ Improvement of protection level.

- Long distance (greater than 30 m) of wire between equipment to be protected and primary SPD :

➔ Reduction of ringing voltages created during the surge transmission.

Efficient SPD coordination is performed by including between primary and secondary SPDs :

- a minimum length of wire (> 10 m).

or

- a decoupling coil.

## Coordination of Surge Protector

### Coordination of Surge Protectors

In order to provide maximum protection efficiency, it is necessary to create a coordination diagram, that means installation of a primary SPD at the network entrance and a secondary close to sensitive equipment.

#### Coordination by conductor

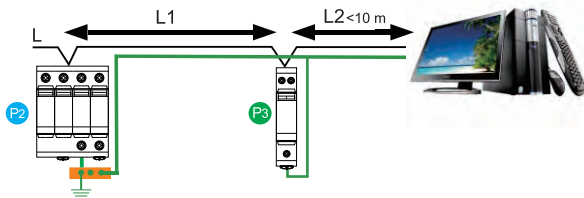

In order to provide maximum protection efficiency, it is necessary to create a coordination diagram: that means installation of a primary SPD at the network entrance and a secondary close to sensitive equipment.

Efficient SPD coordination is performed by including, between primary and secondary SPDs :

-a minimum length of wire (> 10 m).

or

-coordination inductors (BRCI range: see below).

#### Coordination by inductor

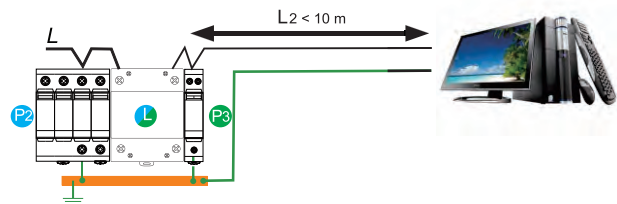

P2 : Primary surge protector (ex. BR-40)

P3 : Secondary surge protector (ex. BR-20DP)

L : Coordination inductors (ex. BRCI)

L1 : Length of conductor between surge protector

L2 : Length of conductor between surge protector and installation

#### Example of coordination on 3-Phase network.

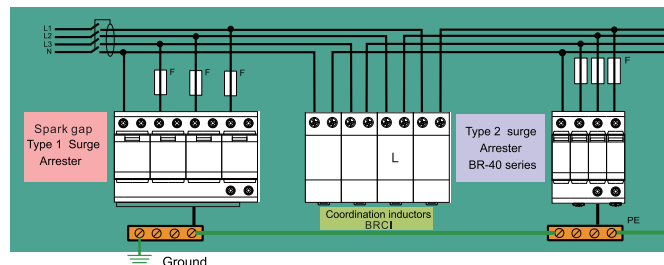

D : Breaker  
F : Backup disconnector  
(fuse or circuit-breaker)  
L : Coordination inductor

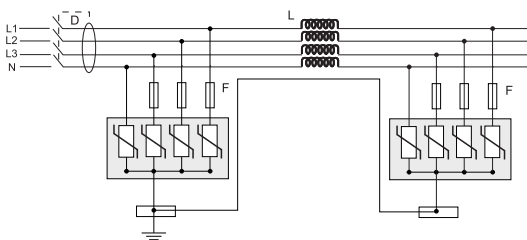

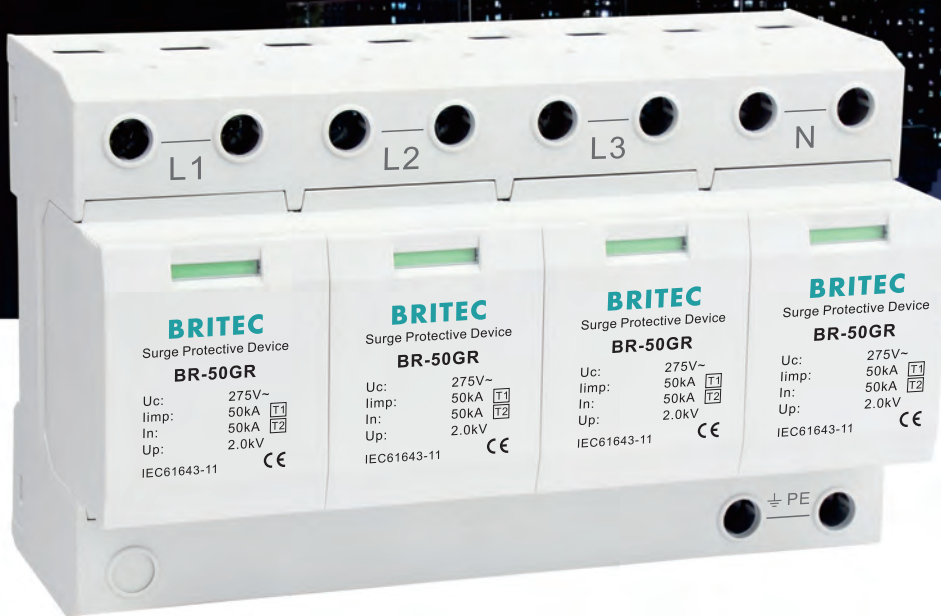

## | Type 1 Surge Arrester

[www.britecelectric.com](http://www.britecelectric.com)

## BR-50GR 4P Type1 Surge Arrester

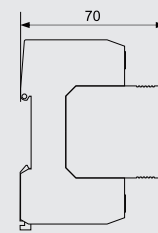
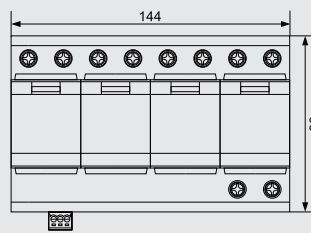
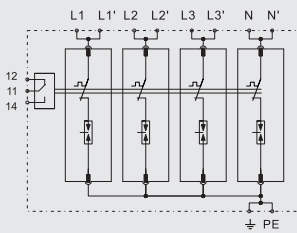
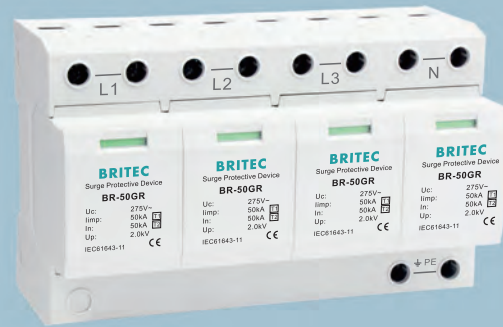

BR-50GR 4P is suitable for TN-S system.

	BR-50GR 150 4P	BR-50GR 275 4P	BR-50GR 350 4P	
SPD classification according to EN61643-11	Type 1 + Type 2	Type 1 + Type 2	Type 1 + Type 2	
SPD classification according to IEC61643-11	Class I + Class II	Class I + Class II	Class I + Class II	
Nominal operating voltage	Un	120/240V (50/60Hz)	250/440V(50/60Hz)	
Max. continuous operating a.c. voltage	Uc	150V (50/60Hz)	275V (50/60Hz)	350V (50/60Hz)
Lightning impulse current (10/350µs)	Iimp	50kA	50kA	50kA
Nominal discharge current (8/20µs)	In	50kA	50kA	50kA
Maximum discharge current (8/20µs)	I <sub>max</sub>	160kA	160kA	160kA
Quantity of electric charge	Q	25As	25As	25As
Specific energy	W/R	625kJ/Ω	625kJ/Ω	625kJ/Ω
Voltage protection level	Up	≤2.0kV	≤2.0kV	≤2.0kV
Short-circuit current rating a.c.	I <sub>SCCR</sub>	25kA rms	25kA rms	25kA rms
Max. backup fuse		315A gG	315A gG	315A gG
Temporary overvoltage TOV-withstand	U <sub>T</sub>	230V/120min.	440V/120min.	580V/120min.
Leakage current	I <sub>PE</sub>	<0.1mA	<0.1mA	<0.1mA
Response time	t <sub>A</sub>	≤100ns	≤100ns	≤100ns
Operating temperature range	T <sub>u</sub>	-40°C-80°C	-40°C-80°C	-40°C-80°C
Operating state/fault indication		green/red	green/red	green/red
Cross-section area (Min.)		4mm <sup>2</sup>	4mm <sup>2</sup>	4mm <sup>2</sup>
Cross-section area(Max.)		35mm <sup>2</sup>	35mm <sup>2</sup>	35mm <sup>2</sup>
For mounting on		35mm Din rail	35mm Din rail	35mm Din rail
Enclosure material		Thermoplastic UL94-V0	Thermoplastic UL94-V0	Thermoplastic UL94-V0
Degree of protection		IP20	IP20	IP20
Order Code		B17158	B18147	B17184
Order Code (With remote signaling)		B17159	B18148	B17185

## BR-50GR 3P Type1 Surge Arrester

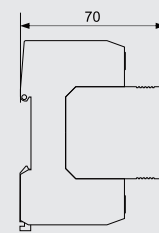
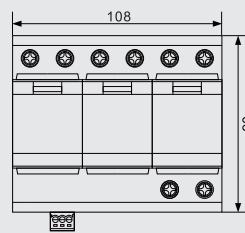
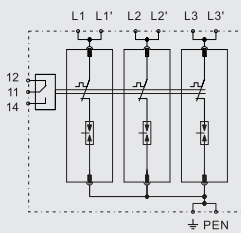
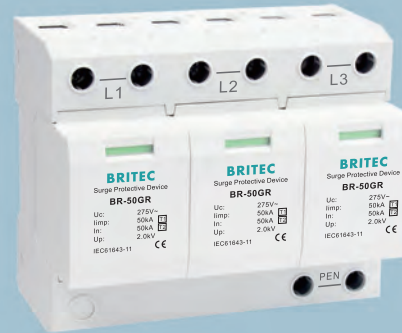

■ BR-50GR 3P is suitable for TN-C system.

		BR-50GR 150 3P	BR-50GR 275 3P	BR-50GR 350 3P
SPD classification according to EN61643-11		Type 1 + Type 2	Type 1 + Type 2	Type 1 + Type 2
SPD classification according to IEC61643-11		Class I + Class II	Class I + Class II	Class I + Class II
Nominal operating voltage	Un	120/240V (50/60Hz)	230/400V(50/60Hz)	250/440V(50/60Hz)
Max. continuous operating a.c. voltage	Uc	150V (50/60Hz)	275V (50/60Hz)	350V (50/60Hz)
Lightning impulse current (10/350µs)	Iimp	50kA	50kA	50kA
Nominal discharge current (8/20µs)	In	50kA	50kA	50kA
Maximum discharge current (8/20µs)	I <sub>max</sub>	160kA	160kA	160kA
Quantity of electric charge	Q	25As	25As	25As
Specific energy	W/R	625kJ/Ω	625kJ/Ω	625kJ/Ω
Voltage protection level	Up	≤2.0kV	≤2.0kV	≤2.0kV
Short-circuit current rating a.c.	I <sub>SCCR</sub>	25kA rms	25kA rms	25kA rms
Max. backup fuse		315A gG	315A gG	315A gG
Temporary overvoltage TOV-withstand	UT	230V/120min.	440V/120min.	580V/120min.
Leakage current	I <sub>PE</sub>	<0.1mA	<0.1mA	<0.1mA
Response time	t <sub>A</sub>	≤100ns	≤100ns	≤100ns
Operating temperature range	T <sub>u</sub>	-40°C-80°C	-40°C-80°C	-40°C-80°C
Operating state/fault indication		green/red	green/red	green/red
Cross-section area (Min.)		4mm <sup>2</sup>	4mm <sup>2</sup>	4mm <sup>2</sup>
Cross-section area(Max.)		35mm <sup>2</sup>	35mm <sup>2</sup>	35mm <sup>2</sup>
For mounting on		35mm Din rail	35mm Din rail	35mm Din rail
Enclosure material		Thermoplastic UL94-V0	Thermoplastic UL94-V0	Thermoplastic UL94-V0
Degree of protection		IP20	IP20	IP20
Order Code		B17160	B18137	B17186
Order Code (With remote signaling)		B17161	B18138	B17187

## BR-50GR 2P Type 1 Surge Arrester

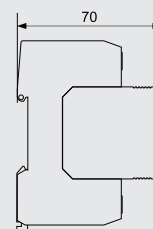
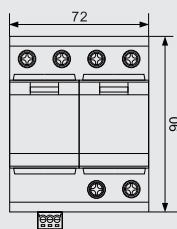
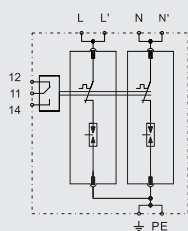

■ BR-50GR 2P surge arrester is suitable for single phase TN system.

		BR-50GR 150 2P	BR-50GR 275 2P	BR-50GR 350 2P
SPD classification according to EN61643-11		Type 1 + Type 2	Type 1 + Type 2	Type 1 + Type 2
SPD classification according to IEC61643-11		Class I + Class II	Class I + Class II	Class I + Class II
Nominal operating voltage	U <sub>n</sub>	120/240V (50/60Hz)	230/400V(50/60Hz)	250/440V(50/60Hz)
Max. continuous operating a.c. voltage	U <sub>c</sub>	150V (50/60Hz)	275V (50/60Hz)	350V (50/60Hz)
Lightning impulse current (10/350μs)	I <sub>imp</sub>	50kA	50kA	50kA
Nominal discharge current (8/20μs)	I <sub>n</sub>	50kA	50kA	50kA
Maximum discharge current (8/20μs)	I <sub>max</sub>	160kA	160kA	160kA
Quantity of electric charge	Q	25As	25As	25As
Specific energy	W/R	625kJ/Ω	625kJ/Ω	625kJ/Ω
Voltage protection level	U <sub>p</sub>	≤2.0kV	≤2.0kV	≤2.0kV
Short-circuit current rating a.c.	I <sub>SCCR</sub>	25kA rms	25kA rms	25kA rms
Max. backup fuse		315A gG	315A gG	315A gG
Temporary overvoltage TOV-withstand	U <sub>T</sub>	230V/120min.	440V/120min.	580V/120min.
Leakage current	I <sub>PE</sub>	<0.1mA	<0.1mA	<0.1mA
Response time	t <sub>A</sub>	≤100ns	≤100ns	≤100ns
Operating temperature range	T <sub>u</sub>	-40°C-80°C	-40°C-80°C	-40°C-80°C
Operating state/fault indication		green/red	green/red	green/red
Cross-section area (Min.)		4mm <sup>2</sup>	4mm <sup>2</sup>	4mm <sup>2</sup>
Cross-section area(Max.)		35mm <sup>2</sup>	35mm <sup>2</sup>	35mm <sup>2</sup>
For mounting on		35mm Din rail	35mm Din rail	35mm Din rail
Enclosure material		Thermoplastic UL94-V0	Thermoplastic UL94-V0	Thermoplastic UL94-V0
Degree of protection		IP20	IP20	IP20
Order Code		B17162	B18127	B17188
Order Code (With remote signaling)		B17163	B18128	B17189

## BR-50GR 1P Type 1 Surge Arrester

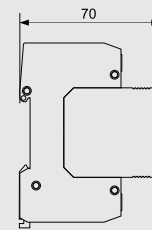
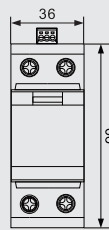
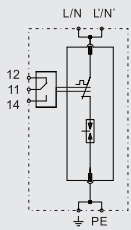

■ BR-50GR 1P can be used to build 2P, 3P and 4P surge arresters.

	BR-50GR 150 1P	BR-50GR 275 1P	BR-50GR 350 1P
SPD classification according to EN61643-11	Type 1 + Type 2	Type 1 + Type 2	Type 1 + Type 2
SPD classification according to IEC61643-11	Class I + Class II	Class I + Class II	Class I + Class II
Nominal operating voltage $U_n$	120/240V (50/60Hz)	230/400V (50/60Hz)	250/440V(50/60Hz)
Max. continuous operating a.c. voltage $U_c$	150V (50/60Hz)	275V (50/60Hz)	350V (50/60Hz)
Lightning impulse current (10/350 $\mu$ s) $I_{imp}$	50kA	50kA	50kA
Nominal discharge current (8/20 $\mu$ s) $I_n$	50kA	50kA	50kA
Maximum discharge current (8/20 $\mu$ s) $I_{max}$	160kA	160kA	160kA
Quantity of electric charge $Q$	25As	25As	25As
Specific energy $W/R$	625kJ/ $\Omega$	625kJ/ $\Omega$	625kJ/ $\Omega$
Voltage protection level $U_p$	$\leq 2.0kV$	$\leq 2.0kV$	$\leq 2.0kV$
Short-circuit current rating a.c. $I_{SCCR}$	25kA rms	25kA rms	25kA rms
Max. backup fuse	315A gG	315A gG	315A gG
Temporary overvoltage TOV-withstand $U_T$	230V/120min.	440V/120min.	580V/120min.
Leakage current $I_{PE}$	<0.1mA	<0.1mA	<0.1mA
Response time $t_A$	$\leq 100ns$	$\leq 100ns$	$\leq 100ns$
Operating temperature range $T_u$	-40°C-80°C	-40°C-80°C	-40°C-80°C
Operating state/fault indication	green/red	green/red	green/red
Cross-section area (Min.)	4mm <sup>2</sup>	4mm <sup>2</sup>	4mm <sup>2</sup>
Cross-section area(Max.)	35mm <sup>2</sup>	35mm <sup>2</sup>	35mm <sup>2</sup>
For mounting on	35mm Din rail	35mm Din rail	35mm Din rail
Enclosure material	Thermoplastic UL94-V0	Thermoplastic UL94-V0	Thermoplastic UL94-V0
Degree of protection	IP20	IP20	IP20
Order Code	B17164	B18117	B17190
Order Code (With remote signaling)	B17165	B18118	B17191

## BR-50GR 3+1 Type 1 Surge Arrester

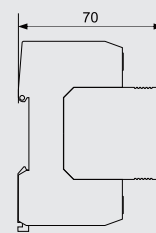
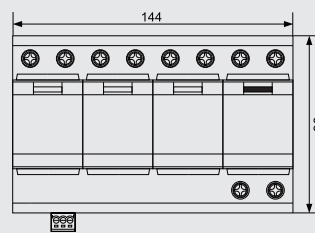
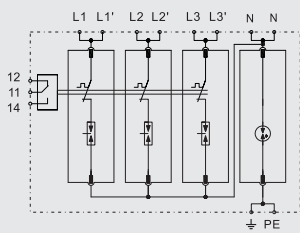
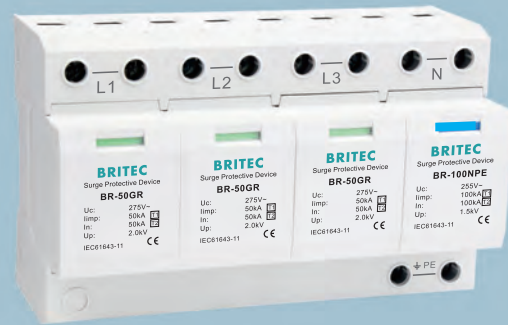

■ BR-50GR 3+1 surge arrester is suitable for TT and TN-S system.

	BR-50GR 150 3+1	BR-50GR 275 3+1	BR-50GR 350 3+1
SPD classification according to EN61643-11	Type 1 + Type 2	Type 1 + Type 2	Type 1 + Type 2
SPD classification according to IEC61643-11	Class I + Class II	Class I + Class II	Class I + Class II
Nominal operating voltage	Un	120/240V (50/60Hz)	230/400V (50/60Hz)
Max. continuous operating a.c. voltage	Uc (L-N/N-PE)	150V/255V (50/60Hz)	275V/255V (50/60Hz)
Lightning impulse current (10/350µs)	Iimp (L-N/N-PE)	50kA/100kA	50kA/100kA
Nominal discharge current (8/20µs)	In (L-N/N-PE)	50kA/100kA	50kA/100kA
Maximum discharge current (8/20µs)	Imax (L-N/N-PE)	160kA/200kA	160kA/200kA
Quantity of electric charge (L-N,N-PE)	Q	25As, 50As	25As, 50As
Specific energy (L-N,N-PE)	W/R	625kJ/Ω, 2500kJ/Ω	625kJ/Ω, 2500kJ/Ω
Voltage protection level	Up (L-N/N-PE)	≤2.0kV/≤1.5kV	≤2.0kV/≤1.5kV
Short-circuit current rating a.c.	I <sub>SCCR</sub> (L-N/N-PE)	25kA rms/100A rms	25kA rms/100A rms
Max. backup fuse		315A gG	315A gG
Temporary overvoltage TOV-withstand	UT (L-N)	230V/120min.	440V/120min.
Temporary overvoltage TOV-withstand	UT (N-PE)	1200V/200ms	1200V/200ms
Leakage current	I <sub>PE</sub>	None	None
Response time	t <sub>A</sub>	≤100ns	≤100ns
Operating temperature range	T <sub>u</sub>	-40°C-80°C	-40°C-80°C
Operating state/fault indication		green/red	green/red
Cross-section area (Min.)		4mm <sup>2</sup>	4mm <sup>2</sup>
Cross-section area(Max.)		35mm <sup>2</sup>	35mm <sup>2</sup>
For mounting on		35mm Din rail	35mm Din rail
Enclosure material		Thermoplastic UL94-V0	Thermoplastic UL94-V0
Degree of protection		IP20	IP20
Order Code		B17166	B17192
Order Code (With remote signaling)		B17167	B17193

## BR-50GR 1+1 Type 1 Surge Arrester

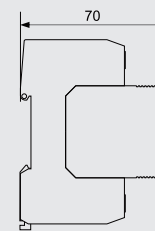
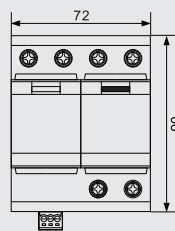
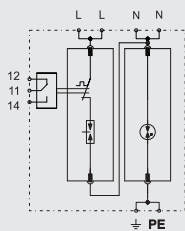

■ BR-50GR 1+1 surge arrester is suitable for single phase TT and TN system.

	BR-50GR 150 1+1	BR-50GR 275 1+1	BR-50GR 350 1+1
SPD classification according to EN61643-11	Type 1 + Type 2	Type 1 + Type 2	Type 1 + Type 2
SPD classification according to IEC61643-11	Class I + Class II	Class I + Class II	Class I + Class II
Nominal operating voltage $U_n$	120/240V (50/60Hz)	230/400V (50/60Hz)	250/440V(50/60Hz)
Max. continuous operating a.c. voltage $U_c$ (L-N/N-PE)	150V/255V (50/60Hz)	275V/255V (50/60Hz)	350V/255V (50/60Hz)
Lightning impulse current (10/350 $\mu$ s) $I_{imp}$ (L-N/N-PE)	50kA/100kA	50kA/100kA	50kA/100kA
Nominal discharge current (8/20 $\mu$ s) $I_n$ (L-N/N-PE)	50kA/100kA	50kA/100kA	50kA/100kA
Maximum discharge current (8/20 $\mu$ s) $I_{max}$ (L-N/N-PE)	160kA/200kA	160kA/200kA	160kA/200kA
Quantity of electric charge (L-N,N-PE) $Q$	25As, 50As	25As, 50As	25As, 50As
Specific energy (L-N,N-PE) $W/R$	625kJ/ $\Omega$ , 2500kJ/ $\Omega$	625kJ/ $\Omega$ , 2500kJ/ $\Omega$	625kJ/ $\Omega$ , 2500kJ/ $\Omega$
Voltage protection level $U_p$ (L-N/N-PE)	$\leq 2.0kV/\leq 1.5kV$	$\leq 2.0kV/\leq 1.5kV$	$\leq 2.0kV/\leq 1.5kV$
Short-circuit current rating a.c. $I_{SCCR}$ (L-N/N-PE)	25kA rms/100A rms	25kA rms/100A rms	25kA rms/100A rms
Max. backup fuse	315A gG	315A gG	315A gG
Temporary overvoltage TOV-withstand $U_T$ (L-N)	230V/120min.	440V/120min.	580V/120min.
Temporary overvoltage TOV-withstand $U_T$ (N-PE)	1200V/200ms	1200V/200ms	1200V/200ms
Leakage current $I_{PE}$	None	None	None
Response time $t_A$	$\leq 100ns$	$\leq 100ns$	$\leq 100ns$
Operating temperature range $T_u$	-40°C-80°C	-40°C-80°C	-40°C-80°C
Operating state/fault indication	green/red	green/red	green/red
Cross-section area (Min.)	4mm <sup>2</sup>	4mm <sup>2</sup>	4mm <sup>2</sup>
Cross-section area(Max.)	35mm <sup>2</sup>	35mm <sup>2</sup>	35mm <sup>2</sup>
For mounting on	35mm Din rail	35mm Din rail	35mm Din rail
Enclosure material	Thermoplastic UL94-V0	Thermoplastic UL94-V0	Thermoplastic UL94-V0
Degree of protection	IP20	IP20	IP20
Order Code	B17168	B18157	B17194
Order Code (With remote signaling)	B17169	B18158	B17195

## BR-25M 4P

Type 1+Type 2+Type 3  
Surge Arrester

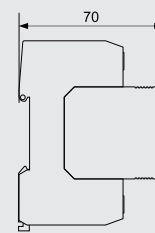
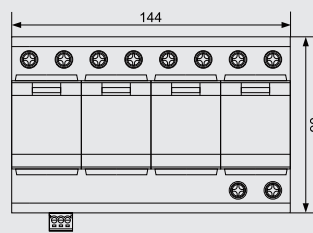
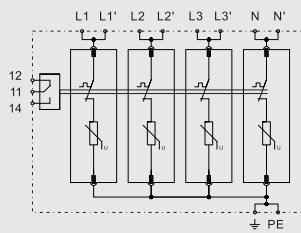
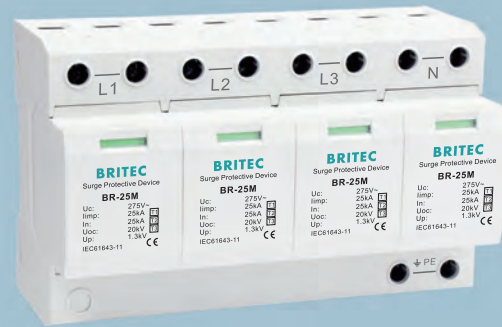

BR-25M 4P is suitable for TN-S system.

	BR-25M 150 4P	BR-25M 275 4P	BR-25M 320 4P
SPD classification according to EN61643-11	Type 1 + Type 2 + Type 3	Type 1 + Type 2 + Type 3	Type 1 + Type 2 + Type 3
SPD classification according to IEC61643-11	Class I + Class II + Class III	Class I + Class II + Class III	Class I + Class II + Class III
Nominal operating voltage	Un	120/240V (50/60Hz)	250/440V(50/60Hz)
Max. continuous operating a.c. voltage	Uc	150V (50/60Hz)	275V (50/60Hz)
Lightning impulse current (10/350µs)	Iimp	25kA	25kA
Total discharge current (10/350µs)	Itotal	100kA	100kA
Nominal discharge current (8/20µs)	In	25kA	25kA
Maximum discharge current (8/20µs)	I <sub>max</sub>	120kA	120kA
Combined impulse	Uoc	20kV	20kV
Quantity of electric charge	Q	12.5As	12.5As
Specific energy	W/R	156kJ/Ω	156kJ/Ω
Voltage protection level	Up	≤0.8kV	≤1.3kV
Short-circuit current rating a.c.	I <sub>SCCR</sub>	25kA rms	25kA rms
Max. backup fuse		200A gG	200A gG
Temporary overvoltage TOV-withstand	U <sub>T</sub>	180V/5sec.	335V/5sec.
Temporary overvoltage TOV-safe failure	U <sub>T</sub>	230V/120min.	440V/120min.
Leakage current	I <sub>PE</sub>	<0.5mA	<0.5mA
Response time	t <sub>A</sub>	≤25ns	≤25ns
Operating temperature range	T <sub>u</sub>	-40°C-80°C	-40°C-80°C
Operating state/fault indication		green/red	green/red
Cross-section area (Min.)		4mm <sup>2</sup>	4mm <sup>2</sup>
Cross-section area(Max.)		35mm <sup>2</sup>	35mm <sup>2</sup>
For mounting on		35mm Din rail	35mm Din rail
Enclosure material		Thermoplastic UL94-V0	Thermoplastic UL94-V0
Degree of protection		IP20	IP20
Order Code		B17200	B17213
Order Code (With remote signaling)		B17201	B17214

## BR-25M 3P

Type 1+Type 2+Type 3  
Surge Arrester

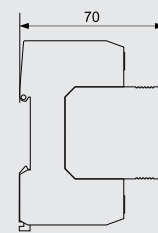
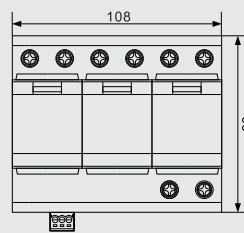
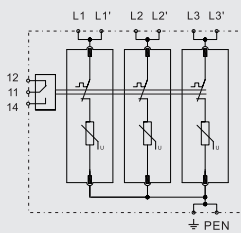

■ BR-25M 3P is suitable for TN-C system.

		BR-25M 150 3P	BR-25M 275 3P	BR-25M 320 3P
SPD classification according to EN61643-11		Type 1 + Type 2 + Type 3	Type 1 + Type 2 + Type 3	Type 1 + Type 2 + Type 3
SPD classification according to IEC61643-11		Class I + Class II + Class III	Class I + Class II + Class III	Class I + Class II + Class III
Nominal operating voltage	Un	120/240V (50/60Hz)	230/400V (50/60Hz)	250/440V(50/60Hz)
Max. continuous operating a.c. voltage	Uc	150V (50/60Hz)	275V (50/60Hz)	320V (50/60Hz)
Lightning impulse current (10/350µs)	Iimp	25kA	25kA	25kA
Total discharge current (10/350µs)	Itotal	75kA	75kA	75kA
Nominal discharge current (8/20µs)	In	25kA	25kA	25kA
Maximum discharge current (8/20µs)	I <sub>max</sub>	120kA	120kA	120kA
Combined impulse	Uoc	20kV	20kV	20kV
Quantity of electric charge	Q	12.5As	12.5As	12.5As
Specific energy	W/R	156kJ/Ω	156kJ/Ω	156kJ/Ω
Voltage protection level	Up	≤0.8kV	≤1.3kV	≤1.3kV
Short-circuit current rating a.c.	I <sub>SCCR</sub>	25kA rms	25kA rms	25kA rms
Max. backup fuse		200A gG	200A gG	200A gG
Temporary overvoltage TOV-withstand	UT	180V/5sec.	335V/5sec.	400V/5sec.
Temporary overvoltage TOV-safe failure	UT	230V/120min.	440V/120min.	520V/120min.
Leakage current	I <sub>PE</sub>	<0.5mA	<0.5mA	<0.5mA
Response time	t <sub>A</sub>	≤25ns	≤25ns	≤25ns
Operating temperature range	T <sub>u</sub>	-40°C-80°C	-40°C-80°C	-40°C-80°C
Operating state/fault indication		green/red	green/red	green/red
Cross-section area (Min.)		4mm <sup>2</sup>	4mm <sup>2</sup>	4mm <sup>2</sup>
Cross-section area(Max.)		35mm <sup>2</sup>	35mm <sup>2</sup>	35mm <sup>2</sup>
For mounting on		35mm Din rail	35mm Din rail	35mm Din rail
Enclosure material		Thermoplastic UL94-V0	Thermoplastic UL94-V0	Thermoplastic UL94-V0
Degree of protection		IP20	IP20	IP20
Order Code		B17202	B18133	B17215
Order Code (With remote signaling)		B17203	B18134	B17216

## BR-25M 2P

Type 1+Type 2+Type 3  
Surge Arrester

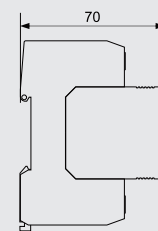
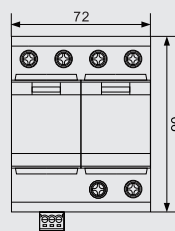
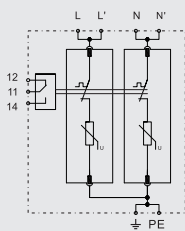

■ BR-25M 2P surge arrester is suitable for single phase TN system.

		BR-25M 150 2P	BR-25M 275 2P	BR-25M 320 2P
SPD classification according to EN61643-11		Type 1 + Type 2 + Type 3	Type 1 + Type 2 + Type 3	Type 1 + Type 2 + Type 3
SPD classification according to IEC61643-11		Class I + Class II + Class III	Class I + Class II + Class III	Class I + Class II + Class III
Nominal operating voltage	Un	120/240V (50/60Hz)	230/400V (50/60Hz)	250/440V(50/60Hz)
Max. continuous operating a.c. voltage	Uc	150V (50/60Hz)	275V (50/60Hz)	320V (50/60Hz)
Lightning impulse current (10/350µs)	Iimp	25kA	25kA	25kA
Total discharge current (10/350µs)	Itotal	50kA	50kA	50kA
Nominal discharge current (8/20µs)	In	25kA	25kA	25kA
Maximum discharge current (8/20µs)	I <sub>max</sub>	120kA	120kA	120kA
Combined impluse	Uoc	20kV	20kV	20kV
Quantity of electric charge	Q	12.5As	12.5As	12.5As
Specific energy	W/R	156kJ/Ω	156kJ/Ω	156kJ/Ω
Voltage protection level	Up	≤ 0.8kV	≤ 1.3kV	≤ 1.3kV
Short-circuit current rating a.c.	I <sub>SCCR</sub>	25kA rms	25kA rms	25kA rms
Max. backup fuse		200A gG	200A gG	200A gG
Temporary overvoltage TOV-withstand	UT	180V/5sec.	335V/5sec.	400V/5sec.
Temporary overvoltage TOV-safe failure	UT	230V/120min.	440V/120min.	520V/120min.
Leakage current	I <sub>PE</sub>	< 2mA	< 2mA	< 2mA
Response time	t <sub>A</sub>	≤ 25ns	≤ 25ns	≤ 25ns
Operating temperature range	Tu	-40°C-80°C	-40°C-80°C	-40°C-80°C
Operating state/fault indication		green/red	green/red	green/red
Cross-section area (Min.)		4mm <sup>2</sup>	4mm <sup>2</sup>	4mm <sup>2</sup>
Cross-section area(Max.)		35mm <sup>2</sup>	35mm <sup>2</sup>	35mm <sup>2</sup>
For mounting on		35mm Din rail	35mm Din rail	35mm Din rail
Enclosure material		Thermoplastic UL94-V0	Thermoplastic UL94-V0	Thermoplastic UL94-V0
Degree of protection		IP20	IP20	IP20
Order Code		B17204	B18123	B17217
Order Code (With remote signaling)		B17205	B18124	B17218

## BR-25M 1P

Type 1+Type 2+Type 3  
Surge Arrester

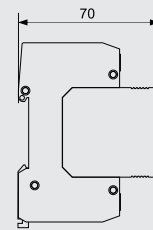
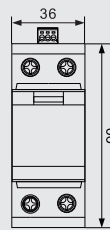
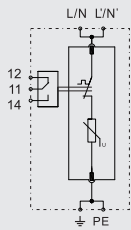

BR-25M 1P can be used to build 2P, 3P and 4P surge arresters.

	BR-25M 150 1P	BR-25M 275 1P	BR-25M 320 1P
SPD classification according to EN61643-11	Type 1 + Type 2 + Type 3	Type 1 + Type 2 + Type 3	Type 1 + Type 2 + Type 3
SPD classification according to IEC61643-11	Class I + Class II + Class III	Class I + Class II + Class III	Class I + Class II + Class III
Nominal operating voltage	Un	120/240V (50/60Hz)	250/440V(50/60Hz)
Max. continuous operating a.c. voltage	Uc	150V (50/60Hz)	275V (50/60Hz)
Lightning impulse current (10/350µs)	Iimp	25kA	25kA
Nominal discharge current (8/20µs)	In	25kA	25kA
Maximum discharge current (8/20µs)	I <sub>max</sub>	120kA	120kA
Combined impulse	Uoc	20kV	20kV
Quantity of electric charge	Q	12.5As	12.5As
Specific energy	W/R	156kJ/Ω	156kJ/Ω
Voltage protection level	Up	≤0.8kV	≤1.3kV
Short-circuit current rating a.c.	I <sub>SCCR</sub>	25kA rms	25kA rms
Max. backup fuse		200A gG	200A gG
Temporary overvoltage TOV-withstand	U <sub>T</sub>	180V/5sec.	335V/5sec.
Temporary overvoltage TOV-safe failure	U <sub>T</sub>	230V/120min.	440V/120min.
Leakage current	I <sub>PE</sub>	<2mA	<2mA
Response time	t <sub>A</sub>	≤25ns	≤25ns
Operating temperature range	T <sub>u</sub>	-40°C-80°C	-40°C-80°C
Operating state/fault indication		green/red	green/red
Cross-section area (Min.)		4mm <sup>2</sup>	4mm <sup>2</sup>
Cross-section area(Max.)		35mm <sup>2</sup>	35mm <sup>2</sup>
For mounting on		35mm Din rail	35mm Din rail
Enclosure material		Thermoplastic UL94-V0	Thermoplastic UL94-V0
Degree of protection		IP20	IP20
Order Code		B17206	B17219
Order Code (With remote signaling)		B17207	B17220

## BR-25M 3+1

Type 1+Type 2+Type 3  
Surge Arrester

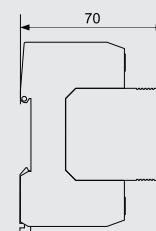
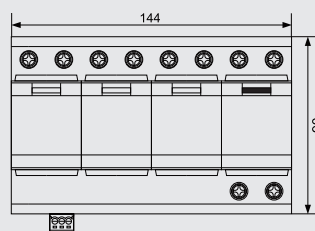
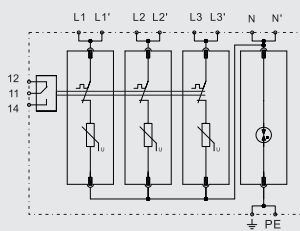
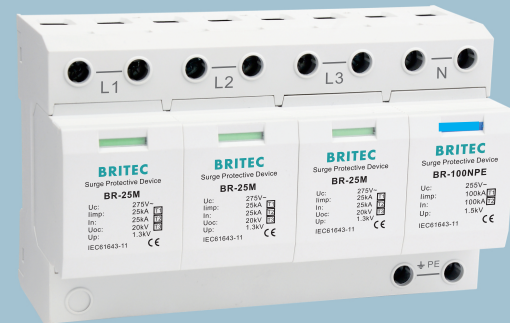

■ BR-25M 3+1 surge arrester is suitable for TT and TN-S system.

	BR-25M 150 3+1	BR-25M 275 3+1	BR-25M 320 3+1
SPD classification according to EN61643-11	Type 1 + Type 2 + Type 3	Type 1 + Type 2 + Type 3	Type 1 + Type 2 + Type 3
SPD classification according to IEC61643-11	Class I + Class II + Class III	Class I + Class II + Class III	Class I + Class II + Class III
Nominal operating voltage	Un	120/240V (50/60Hz)	250/440V(50/60Hz)
Max. continuous operating a.c. voltage	Uc (L-N/N-PE)	150V/255V (50/60Hz)	275V/255V (50/60Hz)
Lightning impulse current (10/350µs)	Iimp (L-N/N-PE)	25kA/100kA	25kA/100kA
Total discharge current (10/350µs)	Itotal	100kA	100kA
Nominal discharge current (8/20µs)	In (L-N/N-PE)	25kA/100kA	25kA/100kA
Maximum discharge current (8/20µs)	I <sub>max</sub> (L-N/N-PE)	120kA/200kA	120kA/200kA
Combined impulse	Uoc	20kV	20kV
Quantity of electric charge (L-N,N-PE)	Q	12.5As, 50As	12.5As, 50As
Specific energy (L-N,N-PE)	W/R	156kJ/Ω, 2500kJ/Ω	156kJ/Ω, 2500kJ/Ω
Voltage protection level	Up (L-N/N-PE)	≤0.8kV/≤1.5kV	≤1.3kV/≤1.5kV
Short-circuit current rating a.c.	I <sub>SCCR</sub> (L-N/N-PE)	25kA rms/100A rms	25kA rms/100A rms
Max. backup fuse		200A gG	200A gG
Temporary overvoltage TOV-withstand	U <sub>T</sub> (L-N)	180V/5sec.	335V/5sec.
Temporary overvoltage TOV-safe failure	U <sub>T</sub> (L-N)	230V/120min.	440V/120min.
Temporary overvoltage TOV-withstand	U <sub>T</sub> (N-PE)	1200V/200ms	1200V/200ms
Leakage current	I <sub>PE</sub>	None	None
Response time	t <sub>A</sub>	≤25ns/≤100ns	≤25ns/≤100ns
Operating temperature range	T <sub>u</sub>	-40°C-80°C	-40°C-80°C
Operating state/fault indication		green/red	green/red
Cross-section area (Min.)		4mm <sup>2</sup>	4mm <sup>2</sup>
Cross-section area(Max.)		35mm <sup>2</sup>	35mm <sup>2</sup>
For mounting on		35mm Din rail	35mm Din rail
Enclosure material		Thermoplastic UL94-V0	Thermoplastic UL94-V0
Degree of protection		IP20	IP20
Order Code		B17208	B17221
Order Code (With remote signaling)		B17209	B17222

## BR-25M 1+1

Type 1+Type 2+Type 3  
Surge Arrester

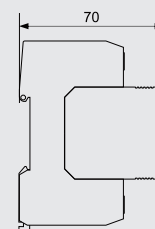
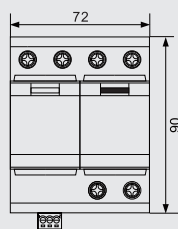
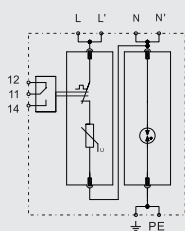

■ BR-25M 1+1 surge arrester is suitable for single phase TT and TN system.

	BR-25M 150 1+1	BR-25M 275 1+1	BR-25M 320 1+1
SPD classification according to EN61643-11	Type 1 + Type 2 + Type 3	Type 1 + Type 2 + Type 3	Type 1 + Type 2 + Type 3
SPD classification according to IEC61643-11	Class I + Class II + Class III	Class I + Class II + Class III	Class I + Class II + Class III
Nominal operating voltage	Un	120V/240V (50/60Hz)	250V/440V(50/60Hz)
Max. continuous operating a.c. voltage	Uc (L-N/N-PE)	150V/255V (50/60Hz)	275V/255V (50/60Hz)
Lightning impulse current (10/350µs)	Iimp (L-N/N-PE)	25kA/50kA	25kA/50kA
Total discharge current (10/350µs)	Itotal	50kA	50kA
Nominal discharge current (8/20µs)	In (L-N/N-PE)	25kA/50kA	25kA/50kA
Maximum discharge current (8/20µs)	I <sub>max</sub> (L-N/N-PE)	120kA	120kA
Combined impulse	Uoc	20kV	20kV
Quantity of electric charge (L-N,N-PE)	Q	12.5As, 25As	12.5As, 25As
Specific energy (L-N,N-PE)	W/R	156kJ/Ω, 625kJ/Ω	156kJ/Ω, 625kJ/Ω
Voltage protection level	Up (L-N/N-PE)	≤0.8kV/≤1.5kV	≤1.3kV/≤1.5kV
Short-circuit current rating a.c.	I <sub>SCCR</sub> (L-N/N-PE)	25kA rms/100A rms	25kA rms/100A rms
Max. backup fuse		200A gG	200A gG
Temporary overvoltage TOV-withstand	U <sub>T</sub> (L-N)	180V/5sec.	335V/5sec.
Temporary overvoltage TOV-safe failure	U <sub>T</sub> (L-N)	230V/120min.	440V/120min.
Temporary overvoltage TOV-withstand	U <sub>T</sub> (N-PE)	1200V/200ms	1200V/200ms
Leakage current	I <sub>PE</sub>	None	None
Response time	t <sub>A</sub>	≤25ns/≤100ns	≤25ns/≤100ns
Operating temperature range	T <sub>u</sub>	-40°C-80°C	-40°C-80°C
Operating state/fault indication		green/red	green/red
Cross-section area (Min.)		4mm <sup>2</sup>	4mm <sup>2</sup>
Cross-section area(Max.)		35mm <sup>2</sup>	35mm <sup>2</sup>
For mounting on		35mm Din rail	35mm Din rail
Enclosure material		Thermoplastic UL94-V0	Thermoplastic UL94-V0
Degree of protection		IP20	IP20
Order Code		B17210	B17223
Order Code (With remote signaling)		B17211	B17224

## BR-25VG 4P

Type 1+Type 2+Type 3  
Surge Arrester

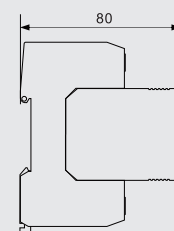
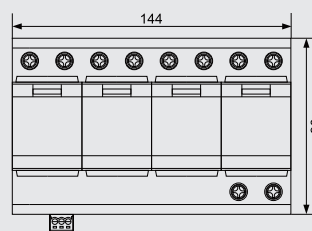
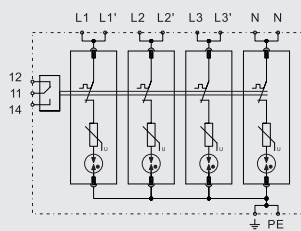
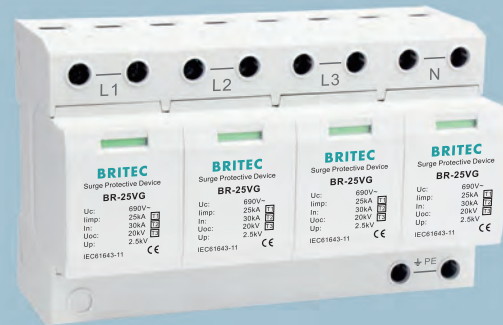

■ BR-25VG 4P is suitable for TN-S system.

	BR-25VG 320 4P	BR-25VG 440 4P	BR-25VG 690 4P
SPD classification according to EN61643-11	Type 1 + Type 2 + Type 3	Type 1 + Type 2 + Type 3	Type 1 + Type 2 + Type 3
SPD classification according to IEC61643-11	Class I + Class II + Class III	Class I + Class II + Class III	Class I + Class II + Class III
Nominal operating voltage	Un	250/440V(50/60Hz)	400/690V(50/60Hz)
Max. continuous operating a.c. voltage	Uc	320V(50/60Hz)	440V(50/60Hz)
Lightning impulse current (10/350µs)	Iimp	25kA	25kA
Total discharge current (10/350µs)	Itotal	100kA	100kA
Nominal discharge current (8/20µs)	In	30kA	30kA
Maximum discharge current (8/20µs)	Imax	100kA	100kA
Combined impluse	Uoc	20kV	20kV
Quantity of electric charge	Q	12.5As	12.5As
Specific energy	W/R	156kJ/Ω	156kJ/Ω
Voltage protection level	Up	≤1.5 kV	≤1.8 kV
Short-circuit current rating a.c.	I <sub>SCCR</sub>	25kA rms	25kA rms
Max. backup fuse		200A gG	200A gG
Temporary overvoltage TOV-withstand	UT	400V/5sec.	580V/5sec.
Temporary overvoltage TOV-safe failure	UT	520V/120min.	765V/120min.
Leakage current	I <sub>PE</sub>	None	None
Response time	t <sub>A</sub>	≤100ns	≤100ns
Operating temperature range	Tu	-40°C-80°C	-40°C-80°C
Operating state/fault indication		green/red	green/red
Cross-section area (Min.)		4mm <sup>2</sup>	4mm <sup>2</sup>
Cross-section area(Max.)		35mm <sup>2</sup>	35mm <sup>2</sup>
For mounting on		35mm Din rail	35mm Din rail
Enclosure material		Thermoplastic UL94-V0	Thermoplastic UL94-V0
Degree of protection		IP20	IP20
Order Code		B17261	B17285
Order Code (With remote signaling)		B17262	B17286

## BR-25VG 3P

Type 1+Type 2+Type 3  
Surge Arrester

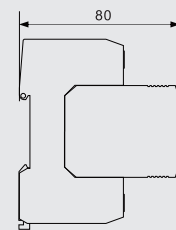
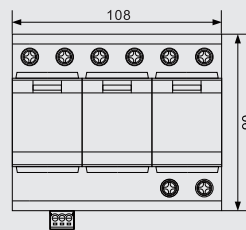
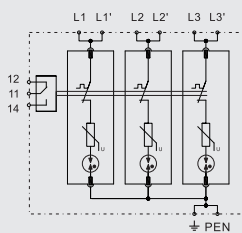
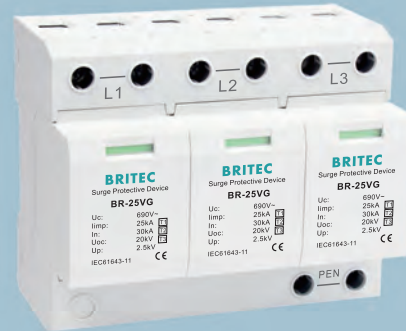

■ BR-25VG 3P is suitable for TN-C system.

	BR-25VG 320 3P	BR-25VG 440 3P	BR-25VG 690 3P
SPD classification according to EN61643-11	Type 1 + Type 2 + Type 3	Type 1 + Type 2 + Type 3	Type 1 + Type 2 + Type 3
SPD classification according to IEC61643-11	Class I + Class II + Class III	Class I + Class II + Class III	Class I + Class II + Class III
Nominal operating voltage	Un	250/440V(50/60Hz)	400/690V(50/60Hz)
Max. continuous operating a.c. voltage	Uc	320V(50/60Hz)	440V(50/60Hz)
Lightning impulse current (10/350µs)	Iimp	25kA	25kA
Total discharge current (10/350µs)	Itotal	75kA	75kA
Nominal discharge current (8/20µs)	In	30kA	30kA
Maximum discharge current (8/20µs)	Imax	100kA	100kA
Combined impulse	Uoc	20kV	20kV
Quantity of electric charge	Q	12.5As	12.5As
Specific energy	W/R	156kJ/Ω	156kJ/Ω
Voltage protection level	Up	≤1.5kV	≤1.8kV
Short-circuit current rating a.c.	I <sub>SCCR</sub>	25kA rms	25kA rms
Max. backup fuse		200A gG	200A gG
Temporary overvoltage TOV-withstand	UT	400V/5sec.	580V/5sec.
Temporary overvoltage TOV-safe failure	UT	520V/120min.	765V/120min.
Leakage current	I <sub>PE</sub>	None	None
Response time	t <sub>A</sub>	≤100ns	≤100ns
Operating temperature range	T <sub>u</sub>	-40°C-80°C	-40°C-80°C
Operating state/fault indication		green/red	green/red
Cross-section area (Min.)		4mm <sup>2</sup>	4mm <sup>2</sup>
Cross-section area(Max.)		35mm <sup>2</sup>	35mm <sup>2</sup>
For mounting on		35mm Din rail	35mm Din rail
Enclosure material		Thermoplastic UL94-V0	Thermoplastic UL94-V0
Degree of protection		IP20	IP20
Order Code		B17263	B17287
Order Code (With remote signaling)		B17264	B17288

## BR-25VG 2P

Type 1+Type 2+Type 3  
Surge Arrester

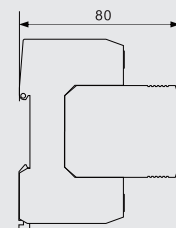
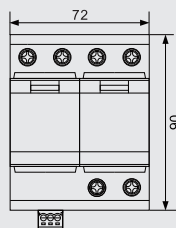
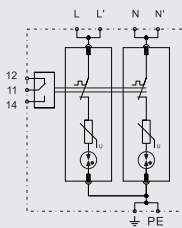

■ BR-25VG 2P is suitable for single phase TN system.

	BR-25VG 320 2P	BR-25VG 440 2P	BR-25VG 690 2P
SPD classification according to EN61643-11	Type 1 + Type 2 + Type 3	Type 1 + Type 2 + Type 3	Type 1 + Type 2 + Type 3
SPD classification according to IEC61643-11	Class I + Class II + Class III	Class I + Class II + Class III	Class I + Class II + Class III
Nominal operating voltage	Un	250/440V(50/60Hz)	400/690V(50/60Hz)
Max. continuous operating a.c. voltage	Uc	320V(50/60Hz)	440V(50/60Hz)
Lightning impulse current (10/350µs)	Iimp	25kA	25kA
Total discharge current (10/350µs)	Itotal	50kA	50kA
Nominal discharge current (8/20µs)	In	30kA	30kA
Maximum discharge current (8/20µs)	Imax	100kA	100kA
Combined impluse	Uoc	20kV	20kV
Quantity of electric charge	Q	12.5As	12.5As
Specific energy	W/R	156kJ/Ω	156kJ/Ω
Voltage protection level	Up	≤1.5 kV	≤1.8 kV
Short-circuit current rating a.c.	IscCR	25kA rms	25kA rms
Max. backup fuse		200A gG	200A gG
Temporary overvoltage TOV-withstand	UT	400V/5sec.	580V/5sec.
Temporary overvoltage TOV-safe failure	UT	520V/120min.	765V/120min.
Leakage current	IPE	None	None
Response time	tA	≤100ns	≤100ns
Operating temperature range	Tu	-40°C-80°C	-40°C-80°C
Operating state/fault indication		green/red	green/red
Cross-section area (Min.)		4mm <sup>2</sup>	4mm <sup>2</sup>
Cross-section area(Max.)		35mm <sup>2</sup>	35mm <sup>2</sup>
For mounting on		35mm Din rail	35mm Din rail
Enclosure material		Thermoplastic UL94-V0	Thermoplastic UL94-V0
Degree of protection		IP20	IP20
Order Code		B17265	B17289
Order Code (With remote signaling)		B17266	B17290

## BR-25VG 1P

Type 1+Type 2+Type 3  
Surge Arrester

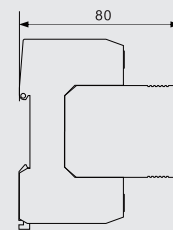
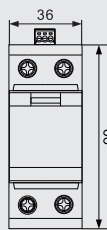
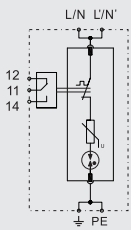

BR-25VG 1P can be used to build 2P, 3P and 4P surge arresters.

	BR-25VG 320 1P	BR-25VG 440 1P	BR-25VG 690 1P
SPD classification according to EN61643-11	Type 1 + Type 2 + Type 3	Type 1 + Type 2 + Type 3	Type 1 + Type 2 + Type 3
SPD classification according to IEC61643-11	Class I + Class II + Class III	Class I + Class II + Class III	Class I + Class II + Class III
Nominal operating voltage	Un	250/440V(50/60Hz)	400/690V(50/60Hz)
Max. continuous operating a.c. voltage	Uc	320V(50/60Hz)	440V(50/60Hz)
Lightning impulse current (10/350µs)	Iimp	25kA	25kA
Nominal discharge current (8/20µs)	In	30kA	30kA
Maximum discharge current (8/20µs)	I <sub>max</sub>	100kA	100kA
Combined impulse	Uoc	20kV	20kV
Quantity of electric charge	Q	12.5As	12.5As
Specific energy	W/R	156kJ/Ω	156kJ/Ω
Voltage protection level	Up	≤1.5kV	≤1.8kV
Short-circuit current rating a.c.	I <sub>SCCR</sub>	25kA rms	25kA rms
Max. backup fuse		200A gG	200A gG
Temporary overvoltage TOV-withstand	UT	400V/5sec.	580V/5sec.
Temporary overvoltage TOV-safe failure	UT	520V/120min.	765V/120min.
Leakage current	I <sub>PE</sub>	None	None
Response time	t <sub>A</sub>	≤100ns	≤100ns
Operating temperature range	Tu	-40°C-80°C	-40°C-80°C
Operating state/fault indication		green/red	green/red
Cross-section area (Min.)		4mm <sup>2</sup>	4mm <sup>2</sup>
Cross-section area(Max.)		35mm <sup>2</sup>	35mm <sup>2</sup>
For mounting on		35mm Din rail	35mm Din rail
Enclosure material		Thermoplastic UL94-V0	Thermoplastic UL94-V0
Degree of protection		IP20	IP20
Order Code		B17267	B17291
Order Code (With remote signaling)		B17268	B17292

## BR-25VG 3+1

Type 1+Type 2+Type 3  
Surge Arrester

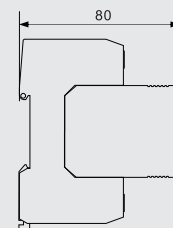
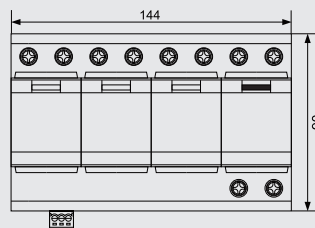
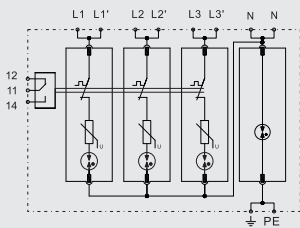
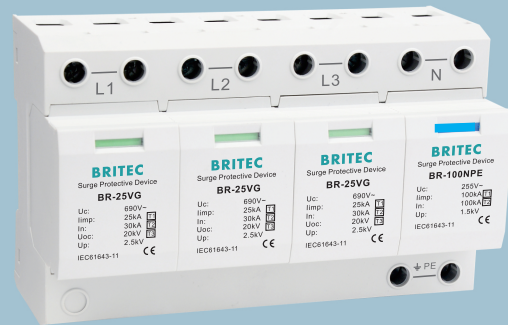

BR-25VG 3+1 is suitable for TT and TN-S system.

	BR-25VG 320 3+1	BR-25VG 440 3+1	BR-25VG 690 3+1
SPD classification according to EN61643-11	Type 1 + Type 2 + Type 3	Type 1 + Type 2 + Type 3	Type 1 + Type 2 + Type 3
SPD classification according to IEC61643-11	Class I + Class II + Class III	Class I + Class II + Class III	Class I + Class II + Class III
Nominal operating voltage $U_n$	250/440V(50/60Hz)	250/440V(50/60Hz)	400/690V(50/60Hz)
Max. continuous operating a.c. voltage $U_c$ (L-N/N-PE)	320V/255V(50/60Hz)	440V/255V(50/60Hz)	690V/255V(50/60Hz)
Lightning impulse current (10/350 $\mu$ s) $I_{imp}$ (L-N/N-PE)	25kA/100kA	25kA/100kA	25kA/100kA
Total discharge current (10/350 $\mu$ s) $I_{total}$	100kA	100kA	100kA
Nominal discharge current (8/20 $\mu$ s) $I_n$ (L-N/N-PE)	30kA/100kA	30kA/100kA	30kA/100kA
Maximum discharge current (8/20 $\mu$ s) $I_{max}$ (L-N/N-PE)	100kA/160kA	100kA/160kA	100kA/160kA
Combined impulse $U_{oc}$	20kV	20kV	20kV
Quantity of electric charge (L-N,N-PE) $Q$	12.5As, 50As	12.5As, 50As	12.5As, 50As
Specific energy (L-N,N-PE) $W/R$	156kJ/ $\Omega$ , 2500kJ/ $\Omega$	156kJ/ $\Omega$ , 2500kJ/ $\Omega$	156kJ/ $\Omega$ , 2500kJ/ $\Omega$
Voltage protection level $U_p$ (L-N/N-PE)	$\leq 1.5kV/\leq 1.5kV$	$\leq 1.8kV/\leq 1.5kV$	$\leq 2.5kV/\leq 1.5kV$
Short-circuit current rating a.c. $I_{SCCR}$ (L-N/N-PE)	25kA rms/100A rms	25kA rms/100A rms	25kA rms/100A rms
Max. backup fuse	200A gG	200A gG	200A gG
Temporary overvoltage TOV-withstand $U_T$ (L-N)	400V/5sec.	580V/5sec.	800V/5sec.
Temporary overvoltage TOV-safe failure $U_T$ (L-N)	520V/120min.	765V/120min.	1000V/120min.
Temporary overvoltage TOV-withstand $U_T$ (N-PE)	1200V/200ms	1200V/200ms	1200V/200ms
Leakage current $I_{PE}$	None	None	None
Response time $t_A$	$\leq 100ns$	$\leq 100ns$	$\leq 100ns$
Operating temperature range $T_u$	-40°C-80°C	-40°C-80°C	-40°C-80°C
Operating state/fault indication	green/red	green/red	green/red
Cross-section area (Min.)	4mm <sup>2</sup>	4mm <sup>2</sup>	4mm <sup>2</sup>
Cross-section area(Max.)	35mm <sup>2</sup>	35mm <sup>2</sup>	35mm <sup>2</sup>
For mounting on	35mm Din rail	35mm Din rail	35mm Din rail
Enclosure material	Thermoplastic UL94-V0	Thermoplastic UL94-V0	Thermoplastic UL94-V0
Degree of protection	IP20	IP20	IP20
Order Code	B17269	B17281	B17293
Order Code (With remote signaling)	B17270	B17282	B17294

## BR-25VG 1+1

Type 1+Type 2+Type 3  
Surge Arrester

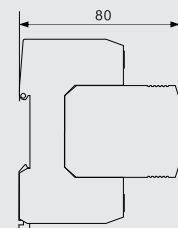
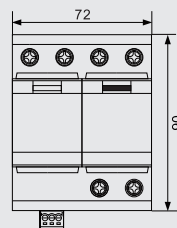
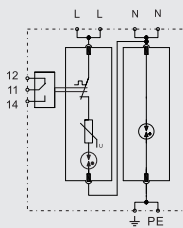

BR-25VG 1+1 is suitable for single phase TT and TN system.

	BR-25VG 320 1+1	BR-25VG 440 1+1	BR-25VG 690 1+1	
SPD classification according to EN61643-11	Type 1 + Type 2 + Type 3	Type 1 + Type 2 + Type 3	Type 1 + Type 2 + Type 3	
SPD classification according to IEC61643-11	Class I + Class II + Class III	Class I + Class II + Class III	Class I + Class II + Class III	
Nominal operating voltage	Un	250/440V(50/60Hz)	400/690V(50/60Hz)	
Max. continuous operating a.c. voltage	Uc (L-N/N-PE)	320V/255V(50/60Hz)	440V/255V(50/60Hz)	690V/255V(50/60Hz)
Lightning impulse current (10/350µs)	Iimp (L-N/N-PE)	25kA/50kA	25kA/50kA	25kA/50kA
Total discharge current (10/350µs)	Itotal	50kA	50kA	50kA
Nominal discharge current (8/20µs)	In (L-N/N-PE)	30kA/50kA	30kA/50kA	30kA/50kA
Maximum discharge current (8/20µs)	I <sub>max</sub> (L-N/N-PE)	100kA/100kA	100kA/100kA	100kA/100kA
Combined impulse	Uoc	20kV	20kV	20kV
Quantity of electric charge (L-N,N-PE)	Q	12.5As, 25As	12.5As, 25As	12.5As, 25As
Specific energy (L-N,N-PE)	W/R	156kJ/Ω, 625kJ/Ω	156kJ/Ω, 625kJ/Ω	156kJ/Ω, 625kJ/Ω
Voltage protection level	Up (L-N/N-PE)	≤1.5 kV/≤1.5kV	≤1.8kV/≤1.5kV	≤2.5kV/≤1.5kV
Short-circuit current rating a.c.	I <sub>SCCR</sub> (L-N/N-PE)	25kA rms/100A rms	25kA rms/100A rms	25kA rms/100A rms
Max. backup fuse		200A gG	200A gG	200A gG
Temporary overvoltage TOV-withstand	U <sub>T</sub> (L-N)	400V/5sec.	580V/5sec.	800V/5sec.
Temporary overvoltage TOV-safe failure	U <sub>T</sub> (L-N)	520V/120min.	765V/120min.	1000V/120min.
Temporary overvoltage TOV-withstand	U <sub>T</sub> (N-PE)	1200V/200ms	1200V/200ms	1200V/200ms
Leakage current	I <sub>PE</sub>	None	None	None
Response time	t <sub>A</sub>	≤100ns	≤100ns	≤100ns
Operating temperature range	T <sub>u</sub>	-40°C-80°C	-40°C-80°C	-40°C-80°C
Operating state/fault indication		green/red	green/red	green/red
Cross-section area (Min.)		4mm <sup>2</sup>	4mm <sup>2</sup>	4mm <sup>2</sup>
Cross-section area(Max.)		35mm <sup>2</sup>	35mm <sup>2</sup>	35mm <sup>2</sup>
For mounting on		35mm Din rail	35mm Din rail	35mm Din rail
Enclosure material		Thermoplastic UL94-V0	Thermoplastic UL94-V0	Thermoplastic UL94-V0
Degree of protection		IP20	IP20	IP20
Order Code		B17271	B17283	B17295
Order Code (With remote signaling)		B17272	B17284	B17296

**B+C**  
Surge Arrester



## T1+T2 Surge Arrester

[www.britecelectric.com](http://www.britecelectric.com)

## BR-12.5M 4P T1+T2 Surge Arrester

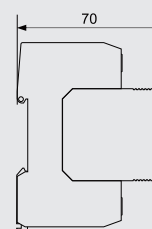
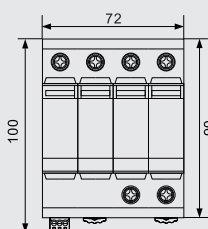
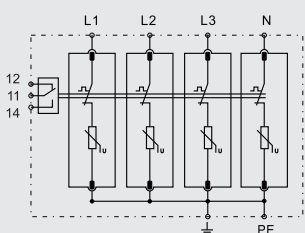

■ BR-12.5M 4P is suitable for TN-S system.

	BR-12.5M 150 4P	BR-12.5M 275 4P	BR-12.5M 320 4P
SPD classification according to EN61643-11	Type 1 + Type 2	Type 1 + Type 2	Type 1 + Type 2
SPD classification according to IEC61643-11	Class I + Class II	Class I + Class II	Class I + Class II
Max. continuous operating a.c. voltage	$U_c$	150V	275V
Lightning impulse current (10/350 $\mu$ s)	$I_{imp}$	12.5kA	12.5kA
Total discharge current (10/350 $\mu$ s)	$I_{total}$	50kA	50kA
Nominal discharge current (8/20 $\mu$ s)	$I_n$	25kA	25kA
Max. discharge current (8/20 $\mu$ s)	$I_{max}$	60kA	60kA
Voltage protection level	$U_p$	$\leq 0.8$ kV	$\leq 1.3$ kV
Specific energy	W/R	39kJ/ $\Omega$	39kJ/ $\Omega$
Short circuit withstand capacity	$I_{SCCR}$	25kA	25kA
Temporary overvoltage TOV-withstand	$U_T$	180V/5sec.	335V/5sec.
Temporary overvoltage TOV-safe failure	$U_T$	230V/120min.	440V/120min.
Max. backup fuse		125A gG	125A gG
Leakage current	$I_{PE}$	<0.5mA	<0.5mA
Response time	$t_A$	$\leq 25$ ns	$\leq 25$ ns
Operating temperature range	$T_u$	-40 $^{\circ}$ C-80 $^{\circ}$ C	-40 $^{\circ}$ C-80 $^{\circ}$ C
Operating state/fault indication		green/red	green/red
Cross-section area (Min.)		4mm $^2$	4mm $^2$
Cross-section area (Max.)		35mm $^2$	35mm $^2$
For mounting on		35mm Din rail	
Enclosure material		Thermoplastic UL94-V0	
Degree of protection		IP20	IP20
Order Code		B18411	B18413
Order Code (With remote signaling)		B18412	B18414

## BR-12.5M 3P

### T1+T2 Surge Arrester

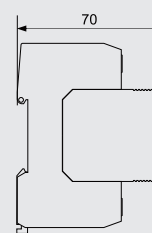
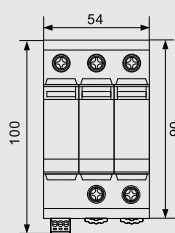
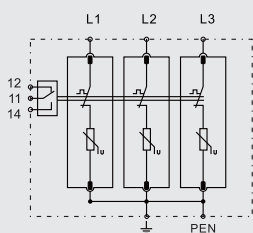

■ BR-12.5M 3P surge arrester is suitable for TN-C system.

	BR-12.5M 150 3P	BR-12.5M 275 3P	BR-12.5M 320 3P
SPD classification according to EN61643-11	Type 1 + Type 2	Type 1 + Type 2	Type 1 + Type 2
SPD classification according to IEC61643-11	Class I + Class II	Class I + Class II	Class I + Class II
Max. continuous operating a.c. voltage $U_c$	150V	275V	320V
Lightning impulse current (10/350 $\mu$ s) $I_{imp}$	12.5kA	12.5kA	12.5kA
Total discharge current (10/350 $\mu$ s) $I_{total}$	37.5kA	37.5kA	37.5kA
Nominal discharge current (8/20 $\mu$ s) $I_n$	25kA	25kA	25kA
Max. discharge current (8/20 $\mu$ s) $I_{max}$	60kA	60kA	60kA
Voltage protection level $U_p$	$\leq 0.8kV$	$\leq 1.3kV$	$\leq 1.5kV$
Specific energy $W/R$	39kJ/ $\Omega$	39kJ/ $\Omega$	39kJ/ $\Omega$
Short circuit withstand capacity $I_{SCCR}$	25kA	25kA	25kA
Temporary overvoltage TOV-withstand $U_T$	180V/5sec.	335V/5sec.	400V/5sec.
Temporary overvoltage TOV-safe failure $U_T$	230V/120min.	440V/120min.	520V/120min.
Max. backup fuse	125A gG	125A gG	125A gG
Leakage current $I_{PE}$	<0.5mA	<0.5mA	<0.5mA
Response time $t_A$	$\leq 25ns$	$\leq 25ns$	$\leq 25ns$
Operating temperature range $T_u$	-40 $^{\circ}C$ -80 $^{\circ}C$	-40 $^{\circ}C$ -80 $^{\circ}C$	-40 $^{\circ}C$ -80 $^{\circ}C$
Operating state/fault indication	green/red	green/red	green/red
Cross-section area (Min.)	4mm <sup>2</sup>	4mm <sup>2</sup>	4mm <sup>2</sup>
Cross-section area (Max.)	35mm <sup>2</sup>	35mm <sup>2</sup>	35mm <sup>2</sup>
For mounting on	35mm Din rail		
Enclosure material	Thermoplastic UL94-V0		
Degree of protection	IP20	IP20	IP20
Order Code	B18311	B18313	B18315
Order Code (With remote signaling)	B18312	B18314	B18316

## BR-12.5M 2P T1+T2 Surge Arrester

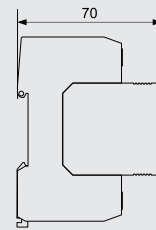
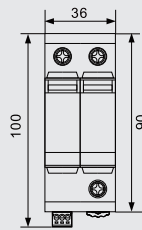
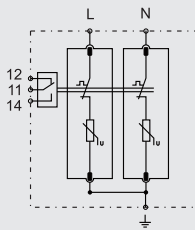

BR-12.5M 2P surge arrester is suitable for single phase TN system.

	BR-12.5M 150 2P	BR-12.5M 275 2P	BR-12.5M 320 2P
SPD classification according to EN61643-11	Type 1 + Type 2	Type 1 + Type 2	Type 1 + Type 2
SPD classification according to IEC61643-11	Class I + Class II	Class I + Class II	Class I + Class II
Max. continuous operating a.c. voltage $U_c$	150V	275V	320V
Lightning impulse current (10/350 $\mu$ s) $I_{imp}$	12.5kA	12.5kA	12.5kA
Total discharge current (10/350 $\mu$ s) $I_{total}$	25kA	25kA	25kA
Nominal discharge current (8/20 $\mu$ s) $I_n$	25kA	25kA	25kA
Max. discharge current (8/20 $\mu$ s) $I_{max}$	60kA	60kA	60kA
Voltage protection level $U_p$	$\leq 0.8kV$	$\leq 1.3kV$	$\leq 1.5kV$
Specific energy $W/R$	39kJ/ $\Omega$	39kJ/ $\Omega$	39kJ/ $\Omega$
Short circuit withstand capacity $I_{SCCR}$	25kA	25kA	25kA
Temporary overvoltage TOV-withstand $U_T$	180V/5sec.	335V/5sec.	400V/5sec.
Temporary overvoltage TOV-safe failure $U_T$	230V/120min.	440V/120min.	520V/120min.
Max. backup fuse	125A gG	125A gG	125A gG
Leakage current $I_{PE}$	<1mA	<1mA	<1mA
Response time $t_A$	$\leq 25ns$	$\leq 25ns$	$\leq 25ns$
Operating temperature range $T_u$	-40 $^{\circ}C$ -80 $^{\circ}C$	-40 $^{\circ}C$ -80 $^{\circ}C$	-40 $^{\circ}C$ -80 $^{\circ}C$
Operating state/fault indication	green/red	green/red	green/red
Cross-section area (Min.)	4mm <sup>2</sup>	4mm <sup>2</sup>	4mm <sup>2</sup>
Cross-section area (Max.)	35mm <sup>2</sup>	35mm <sup>2</sup>	35mm <sup>2</sup>
For mounting on	35mm Din rail		
Enclosure material	Thermoplastic UL94-V0		
Degree of protection	IP20	IP20	IP20
Order Code	B18211	B18213	B18215
Order Code (With remote signaling)	B18212	B18214	B18216

## BR-12.5M 1P T1+T2 Surge Arrester

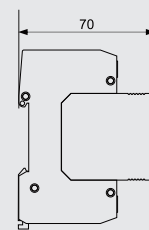
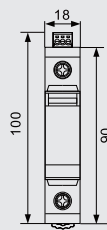
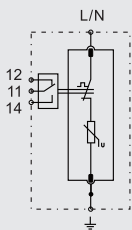

BR-12.5M 1P can be used to build 2P, 3P and 4P surge arresters.

	BR-12.5M 150 1P	BR-12.5M 275 1P	BR-12.5M 320 1P
SPD classification according to EN61643-11	Type 1 + Type 2	Type 1 + Type 2	Type 1 + Type 2
SPD classification according to IEC61643-11	Class I + Class II	Class I + Class II	Class I + Class II
Max. continuous operating a.c. voltage $U_c$	150V	275V	320V
Lightning impulse current (10/350 $\mu$ s) $I_{imp}$	12.5kA	12.5kA	12.5kA
Nominal discharge current (8/20 $\mu$ s) $I_n$	25kA	25kA	25kA
Max. discharge current (8/20 $\mu$ s) $I_{max}$	60kA	60kA	60kA
Voltage protection level $U_p$	$\leq 0.8kV$	$\leq 1.3kV$	$\leq 1.5kV$
Specific energy $W/R$	39kJ/ $\Omega$	39kJ/ $\Omega$	39kJ/ $\Omega$
Short circuit withstand capacity $I_{SCCR}$	25kA	25kA	25kA
Temporary overvoltage TOV-withstand $U_T$	180V/5sec.	335V/5sec.	400V/5sec.
Temporary overvoltage TOV-safe failure $U_T$	230V/120min.	440V/120min.	520V/120min.
Max. backup fuse	125A gG	125A gG	125A gG
Leakage current $I_{PE}$	< 1mA	< 1mA	< 1mA
Response time $t_A$	$\leq 25ns$	$\leq 25ns$	$\leq 25ns$
Operating temperature range $T_u$	-40°C–80°C	-40°C–80°C	-40°C–80°C
Operating state/fault indication	green/red	green/red	green/red
Cross-section area (Min.)	4mm <sup>2</sup>	4mm <sup>2</sup>	4mm <sup>2</sup>
Cross-section area (Max.)	35mm <sup>2</sup>	35mm <sup>2</sup>	35mm <sup>2</sup>
For mounting on	35mm Din rail		
Enclosure material	Thermoplastic UL94-V0		
Degree of protection	IP20	IP20	IP20
Order Code	B18171	B18173	B18175
Order Code (With remote signaling)	B18172	B18174	B18176

## BR-12.5M 3+1 T1+T2 Surge Arrester

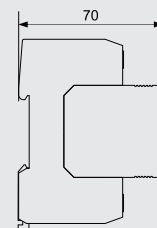
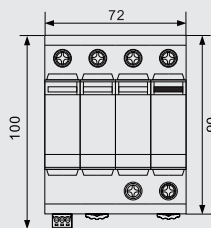
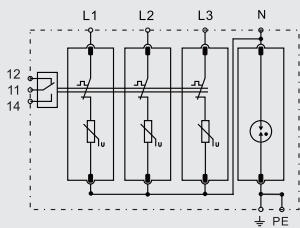
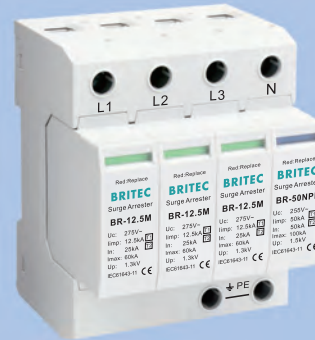

BR-12.5M 3+1 surge arrester is suitable for TT and TN-S system.

	BR-12.5M 150 3+1	BR-12.5M 275 3+1	BR-12.5M 320 3+1
SPD classification according to EN61643-11	Type 1 + Type 2	Type 1 + Type 2	Type 1 + Type 2
SPD classification according to IEC61643-11	Class I + Class II	Class I + Class II	Class I + Class II
Max. continuous operating a.c. voltage $U_c$	150V	275V	320V
Lightning impulse current (10/350 $\mu$ s) (L-N/N-PE) $I_{imp}$	12.5kA/50kA	12.5kA/50kA	12.5kA/50kA
Total discharge current (10/350 $\mu$ s) $I_{total}$	50kA	50kA	50kA
Nominal discharge current (8/20 $\mu$ s) (L-N/N-PE) $I_n$	25kA/50kA	25kA/50kA	25kA/50kA
Max. discharge current (8/20 $\mu$ s) (L-N/N-PE) $I_{max}$	60kA/100kA	60kA/100kA	60kA/100kA
Voltage protection level (L-N/N-PE) $U_p$	$\leq 0.8kV/\leq 1.5kV$	$\leq 1.3kV/\leq 1.5kV$	$\leq 1.5kV/\leq 1.5kV$
Voltage protection level 5kA (L-N/N-PE) $U_p$	$\leq 0.6kV/\leq 1.5kV$	$\leq 1kV/\leq 1.5kV$	$\leq 1.2kV/\leq 1.5kV$
Max. backup fuse	125A gG	125A gG	125A gG
Specific energy (L-N/N-PE) W/R	39kJ/ $\Omega$ /625kJ/ $\Omega$	39kJ/ $\Omega$ /625kJ/ $\Omega$	39kJ/ $\Omega$ /625kJ/ $\Omega$
Short circuit withstand capacity $I_{SCCR}$	25kA	25kA	25kA
Temporary overvoltage TOV-withstand (L-N) $U_T$	180V/5sec.	335V/5sec.	400V/5sec.
Temporary overvoltage TOV-safe failure (L-N) $U_T$	230V/120min.	440V/120min.	520V/120min.
Temporary overvoltage TOV-withstand (N-PE) $U_T$	1200V/200ms	1200V/200ms	1200V/200ms
Leakage current $I_{PE}$	None	None	None
Response time (L-N/N-PE) $t_A$	$\leq 25ns/\leq 100ns$	$\leq 25ns/\leq 100ns$	$\leq 25ns/\leq 100ns$
Operating temperature range $T_u$	-40 $^{\circ}C$ -80 $^{\circ}C$	-40 $^{\circ}C$ -80 $^{\circ}C$	-40 $^{\circ}C$ -80 $^{\circ}C$
Operating state/fault indication	green/red	green/red	green/red
Cross-section area (Min.)	4 mm <sup>2</sup>	4 mm <sup>2</sup>	4 mm <sup>2</sup>
Cross-section area (Max.)	35mm <sup>2</sup>	35mm <sup>2</sup>	35mm <sup>2</sup>
For mounting on	35mm Din rail		
Enclosure material	Thermoplastic UL94-V0		
Degree of protection	IP20	IP20	IP20
Order Code	B18611	B18613	B18615
Order Code (With remote signaling)	B18612	B18614	B18616

## BR-12.5M 1P+N T1+T2 Surge Arrester

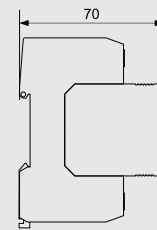
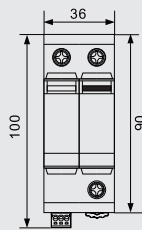
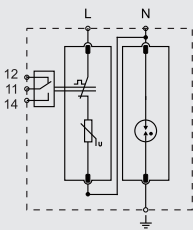

■ BR-12.5M 1+1 surge arrester is suitable for single phase TT and TN system.

	BR-12.5M 150 1P+N	BR-12.5M 275 1P+N	BR-12.5M 320 1P+N
SPD classification according to EN61643-11	Type 1 + Type 2	Type 1 + Type 2	Type 1 + Type 2
SPD classification according to IEC61643-11	Class I + Class II	Class I + Class II	Class I + Class II
Max. continuous operating a.c. voltage $U_c$	150V	275V	320V
Lightning impulse current (10/350 $\mu$ s) (L-N/N-PE) $I_{imp}$	12.5kA/25kA	12.5kA/25kA	12.5kA/25kA
Total discharge current (10/350 $\mu$ s) $I_{total}$	25kA	25kA	25kA
Nominal discharge current (8/20 $\mu$ s) (L-N/N-PE) $I_n$	25kA/50kA	25kA/50kA	25kA/50kA
Max. discharge current (8/20 $\mu$ s) (L-N/N-PE) $I_{max}$	60kA/100kA	60kA/100kA	60kA/100kA
Voltage protection level (L-N/N-PE) $U_p$	$\leq 0.8kV/\leq 1.5kV$	$\leq 1.3kV/\leq 1.5kV$	$\leq 1.5kV/\leq 1.5kV$
Voltage protection level 5kA (L-N/N-PE) $U_p$	$\leq 0.6kV/\leq 1.5kV$	$\leq 1kV/\leq 1.5kV$	$\leq 1.2kV/\leq 1.5kV$
Max. backup fuse	125A gG	125A gG	125A gG
Specific energy (L-N/N-PE) W/R	39kJ/ $\Omega$ /156kJ/ $\Omega$	39kJ/ $\Omega$ /156kJ/ $\Omega$	39kJ/ $\Omega$ /156kJ/ $\Omega$
Short circuit withstand capacity $I_{SCCR}$	25kA	25kA	25kA
Temporary overvoltage TOV-withstand (L-N) $U_T$	180V/5sec.	335V/5sec.	400V/5sec.
Temporary overvoltage TOV-safe failure (L-N) $U_T$	230V/120min.	440V/120min.	520V/120min.
Temporary overvoltage TOV-withstand (N-PE) $U_T$	1200V/200ms	1200V/200ms	1200V/200ms
Leakage current $I_{PE}$	None	None	None
Response time (L-N/N-PE) $t_A$	$\leq 25ns/\leq 100ns$	$\leq 25ns/\leq 100ns$	$\leq 25ns/\leq 100ns$
Operating temperature range $T_u$	-40°C-80°C	-40°C-80°C	-40°C-80°C
Operating state/fault indication	green/red	green/red	green/red
Cross-section area (Min.)	4 mm <sup>2</sup>	4 mm <sup>2</sup>	4 mm <sup>2</sup>
Cross-section area (Max.)	35mm <sup>2</sup>	35mm <sup>2</sup>	35mm <sup>2</sup>
For mounting on	35mm Din rail		
Enclosure material	Thermoplastic UL94-V0		
Degree of protection	IP20	IP20	IP20
Order Code	B18617	B18619	B18621
Order Code (With remote signaling)	B18618	B18620	B18622

## BR-7M 4P

### T1+T2 Surge Arrester

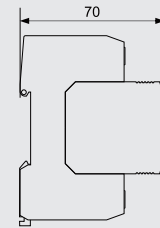
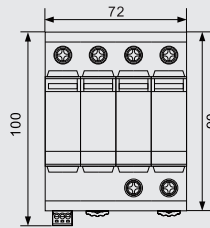
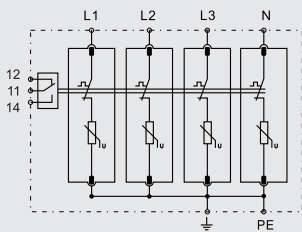

BR-7M 4P surge arrester is suitable for TN-S system.

	BR-7M 150 4P	BR-7M 275 4P	BR-7M 320 4P
SPD classification according to EN61643-11	Type 1 + Type 2	Type 1 + Type 2	Type 1 + Type 2
SPD classification according to IEC61643-11	Class I + Class II	Class I + Class II	Class I + Class II
Max. continuous operating a.c. voltage	$U_c$	150V	275V
Lightning impulse current (10/350 $\mu$ s)	$I_{imp}$	7kA	7kA
Total discharge current (10/350 $\mu$ s)	$I_{total}$	28kA	28kA
Nominal discharge current (8/20 $\mu$ s)	$I_n$	20kA	20kA
Max. discharge current (8/20 $\mu$ s)	$I_{max}$	50kA	50kA
Voltage protection level	$U_p$	$\leq 0.8kV$	$\leq 1.3kV$
Specific energy	W/R	12.25kJ/ $\Omega$	12.25kJ/ $\Omega$
Short circuit withstand capacity	$I_{SCCR}$	25kA	25kA
Temporary overvoltage TOV-withstand	$U_T$	180V/5sec.	335V/5sec.
Temporary overvoltage TOV-safe failure	$U_T$	230V/120min.	440V/120min.
Max. backup fuse		125A gG	125A gG
Leakage current	$I_{PE}$	<0.5mA	<0.5mA
Response time	$t_A$	$\leq 25ns$	$\leq 25ns$
Operating temperature range	$T_u$	-40 $^{\circ}C$ -80 $^{\circ}C$	-40 $^{\circ}C$ -80 $^{\circ}C$
Operating state/fault indication		green/red	green/red
Cross-section area (Min.)		4mm <sup>2</sup>	4mm <sup>2</sup>
Cross-section area (Max.)		35mm <sup>2</sup>	35mm <sup>2</sup>
For mounting on		35mm Din rail	
Enclosure material		Thermoplastic UL94-V0	
Degree of protection		IP20	IP20
Order Code		B17300	B17302
Order Code (With remote signaling)		B17301	B17303

## BR-7M 3P

### T1+T2 Surge Arrester

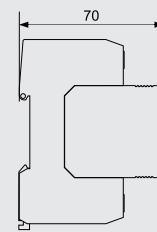
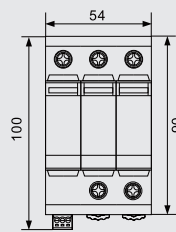
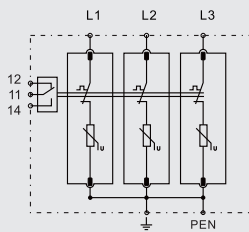

■ BR-7M 3P surge arrester is suitable for TN-C system.

	BR-7M 150 3P	BR-7M 275 3P	BR-7M 320 3P
SPD classification according to EN61643-11	Type 1 + Type 2	Type 1 + Type 2	Type 1 + Type 2
SPD classification according to IEC61643-11	Class I + Class II	Class I + Class II	Class I + Class II
Max. continuous operating a.c. voltage	Uc	150V	275V
Lightning impulse current (10/350µs)	Iimp	7kA	7kA
Total discharge current (10/350µs)	Itotal	21kA	21kA
Nominal discharge current (8/20µs)	In	20kA	20kA
Max. discharge current (8/20µs)	I <sub>max</sub>	50kA	50kA
Voltage protection level	Up	≤0.8kV	≤1.3kV
Specific energy	W/R	12.25kJ/Ω	12.25kJ/Ω
Short circuit withstand capacity	I <sub>SCCR</sub>	25kA	25kA
Temporary overvoltage TOV-withstand	U <sub>T</sub>	180V/5sec.	335V/5sec.
Temporary overvoltage TOV-safe failure	U <sub>T</sub>	230V/120min.	440V/120min.
Max. backup fuse		125A gG	125A gG
Leakage current	I <sub>PE</sub>	<0.5mA	<0.5mA
Response time	t <sub>A</sub>	≤25ns	≤25ns
Operating temperature range	T <sub>u</sub>	-40°C–80°C	-40°C–80°C
Operating state/fault indication		green/red	green/red
Cross-section area (Min.)		4mm <sup>2</sup>	4mm <sup>2</sup>
Cross-section area (Max.)		35mm <sup>2</sup>	35mm <sup>2</sup>
For mounting on		35mm Din rail	
Enclosure material		Thermoplastic UL94-V0	
Degree of protection		IP20	IP20
Order Code		B17306	B17310
Order Code (With remote signaling)		B17307	B17311

## BR-7M 2P

### T1+T2 Surge Arrester

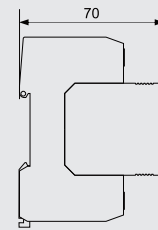
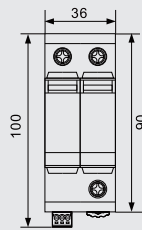
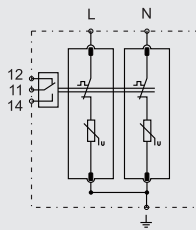
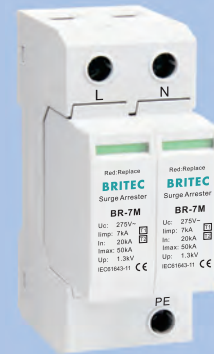

■ BR-7M 2P surge arrester is suitable for single phase TN system.

		BR-7M 150 2P	BR-7M 275 2P	BR-7M 320 2P
SPD classification according to EN61643-11		Type 1 + Type 2	Type 1 + Type 2	Type 1 + Type 2
SPD classification according to IEC61643-11		Class I + Class II	Class I + Class II	Class I + Class II
Max. continuous operating a.c. voltage	$U_c$	150V	275V	320V
Lightning impulse current (10/350 $\mu$ s)	$I_{imp}$	7kA	7kA	7kA
Total discharge current (10/350 $\mu$ s)	$I_{total}$	14kA	14kA	14kA
Nominal discharge current (8/20 $\mu$ s)	$I_n$	20kA	20kA	20kA
Max. discharge current (8/20 $\mu$ s)	$I_{max}$	50kA	50kA	50kA
Voltage protection level	$U_p$	$\leq 0.8kV$	$\leq 1.3kV$	$\leq 1.5kV$
Specific energy	W/R	12.25kJ/ $\Omega$	12.25kJ/ $\Omega$	12.25kJ/ $\Omega$
Short circuit withstand capacity	$I_{SCCR}$	25kA	25kA	25kA
Temporary overvoltage TOV-withstand	$U_T$	180V/5sec.	335V/5sec.	400V/5sec.
Temporary overvoltage TOV-safe failure	$U_T$	230V/120min.	440V/120min.	520V/120min.
Max. backup fuse		125A gG	125A gG	125A gG
Leakage current	$I_{PE}$	<1mA	<1mA	<1mA
Response time	$t_A$	$\leq 25ns$	$\leq 25ns$	$\leq 25ns$
Operating temperature range	$T_u$	-40 $^{\circ}C$ -80 $^{\circ}C$	-40 $^{\circ}C$ -80 $^{\circ}C$	-40 $^{\circ}C$ -80 $^{\circ}C$
Operating state/fault indication		green/red	green/red	green/red
Cross-section area (Min.)		4mm <sup>2</sup>	4mm <sup>2</sup>	4mm <sup>2</sup>
Cross-section area (Max.)		35mm <sup>2</sup>	35mm <sup>2</sup>	35mm <sup>2</sup>
For mounting on		35mm Din rail		
Enclosure material		Thermoplastic UL94-V0		
Degree of protection		IP20	IP20	IP20
Order Code		B17312	B17314	B17316
Order Code (With remote signaling)		B17313	B17315	B17317

## BR-7M 1P

### T1+T2 Surge Arrester

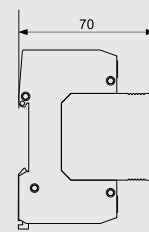
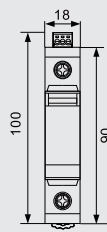
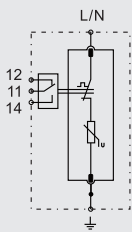

BR-7M 1P can be used to build 2P, 3P and 4P surge arresters.

		BR-7M 150 1P	BR-7M 275 1P	BR-7M 320 1P
SPD classification according to EN61643-11		Type 1 + Type 2	Type 1 + Type 2	Type 1 + Type 2
SPD classification according to IEC61643-11		Class I + Class II	Class I + Class II	Class I + Class II
Max. continuous operating a.c. voltage	$U_c$	150V	275V	320V
Lightning impulse current (10/350 $\mu$ s)	$I_{limp}$	7kA	7kA	7kA
Nominal discharge current (8/20 $\mu$ s)	$I_n$	20kA	20kA	20kA
Max. discharge current (8/20 $\mu$ s)	$I_{max}$	50kA	50kA	50kA
Voltage protection level	$U_p$	$\leq 0.8kV$	$\leq 1.3kV$	$\leq 1.5kV$
Specific energy	W/R	12.25kJ/ $\Omega$	12.25kJ/ $\Omega$	12.25kJ/ $\Omega$
Short circuit withstand capacity	$I_{SCCR}$	25kA	25kA	25kA
Temporary overvoltage TOV-withstand	$U_T$	180V/5sec.	335V/5sec.	400V/5sec.
Temporary overvoltage TOV-safe failure	$U_T$	230V/120min.	440V/120min.	520V/120min.
Max. backup fuse		125A gG	125A gG	125A gG
Leakage current	$I_{PE}$	< 1mA	< 1mA	< 1mA
Response time	$t_A$	$\leq 25ns$	$\leq 25ns$	$\leq 25ns$
Operating temperature range	$T_u$	-40 $^{\circ}C$ -80 $^{\circ}C$	-40 $^{\circ}C$ -80 $^{\circ}C$	-40 $^{\circ}C$ -80 $^{\circ}C$
Operating state/fault indication		green/red	green/red	green/red
Cross-section area (Min.)		4mm <sup>2</sup>	4mm <sup>2</sup>	4mm <sup>2</sup>
Cross-section area (Max.)		35mm <sup>2</sup>	35mm <sup>2</sup>	35mm <sup>2</sup>
For mounting on		35mm Din rail		
Enclosure material		Thermoplastic UL94-V0		
Degree of protection		IP20	IP20	IP20
Order Code		B17318	B17320	B17322
Order Code (With remote signaling)		B17319	B17321	B17323

## BR-7M 3+1

### T1+T2 Surge Arrester

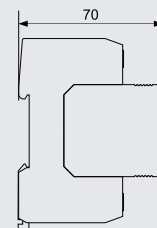
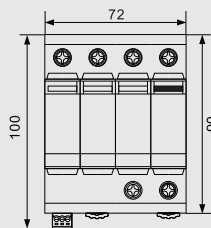
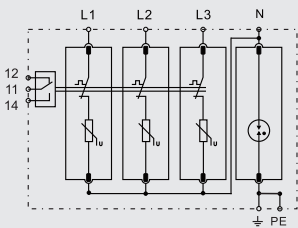
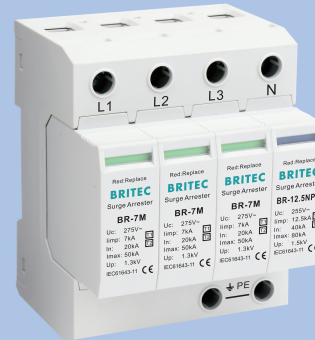

■ BR-7M 3+1 surge arrester is suitable for TT and TN-S system.

	BR-7M 150 3+1	BR-7M 275 3+1	BR-7M 320 3+1
SPD classification according to EN61643-11	Type 1 + Type 2	Type 1 + Type 2	Type 1 + Type 2
SPD classification according to IEC61643-11	Class I + Class II	Class I + Class II	Class I + Class II
Max. continuous operating a.c. voltage $U_c$	150V	275V	320V
Lightning impulse current (10/350 $\mu$ s)(L-N/N-PE) $I_{limp}$	7kA/12.5kA	7kA/12.5kA	7kA/12.5kA
Total discharge current (10/350 $\mu$ s) $I_{total}$	25kA	25kA	25kA
Nominal discharge current (8/20 $\mu$ s) (L-N/N-PE) $I_n$	20kA/40kA	20kA/40kA	20kA/40kA
Max. discharge current (8/20 $\mu$ s) (L-N/N-PE) $I_{max}$	50kA/80kA	50kA/80kA	50kA/80kA
Voltage protection level (L-N/N-PE) $U_p$	$\leq 0.8kV/\leq 1.5kV$	$\leq 1.3kV/\leq 1.5kV$	$\leq 1.5kV/\leq 1.5kV$
Voltage protection level 5kA (L-N/N-PE) $U_p$	$\leq 0.6kV/\leq 1.5kV$	$\leq 1kV/\leq 1.5kV$	$\leq 1.2kV/\leq 1.5kV$
Max. backup fuse	125A gG	125A gG	125A gG
Specific energy (L-N/N-PE) $W/R$	12.25kJ/ $\Omega$ /39kJ/ $\Omega$	12.25kJ/ $\Omega$ /39kJ/ $\Omega$	12.25kJ/ $\Omega$ /39kJ/ $\Omega$
Short circuit withstand capacity $I_{SCCR}$	25kA	25kA	25kA
Temporary overvoltage TOV-withstand (L-N) $U_T$	180V/5sec.	335V/5sec.	400V/5sec.
Temporary overvoltage TOV-safe failure (L-N) $U_T$	230V/120min.	440V/120min.	520V/120min.
Temporary overvoltage TOV-withstand (N-PE) $U_T$	1200V/200ms	1200V/200ms	1200V/200ms
Leakage current $I_{PE}$	None	None	None
Response time (L-N/N-PE) $t_A$	$\leq 25ns/\leq 100ns$	$\leq 25ns/\leq 100ns$	$\leq 25ns/\leq 100ns$
Operating temperature range $T_u$	-40 $^{\circ}C$ -80 $^{\circ}C$	-40 $^{\circ}C$ -80 $^{\circ}C$	-40 $^{\circ}C$ -80 $^{\circ}C$
Operating state/fault indication	green/red	green/red	green/red
Cross-section area (Min.)	4 mm <sup>2</sup>	4 mm <sup>2</sup>	4 mm <sup>2</sup>
Cross-section area (Max.)	35mm <sup>2</sup>	35mm <sup>2</sup>	35mm <sup>2</sup>
For mounting on	35mm Din rail		
Enclosure material	Thermoplastic UL94-V0		
Degree of protection	IP20	IP20	IP20
Order Code	B17324	B17326	B17328
Order Code (With remote signaling)	B17325	B17327	B17329

## BR-7M 1+1

### T1+T2 Surge Arrester

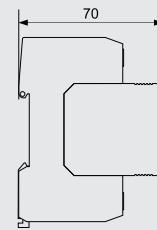
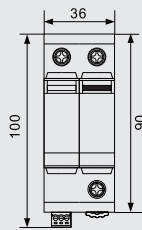
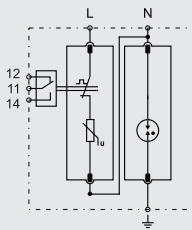

■ BR-7M 1+1 surge arrester is suitable for single phase TT and TN system.

	BR-7M 150 1+1	BR-7M 275 1+1	BR-7M 320 1+1
SPD classification according to EN61643-11	Type 1 + Type 2	Type 1 + Type 2	Type 1 + Type 2
SPD classification according to IEC61643-11	Class I + Class II	Class I + Class II	Class I + Class II
Max. continuous operating a.c. voltage $U_c$	150V	275V	320V
Lightning impulse current (10/350 $\mu$ s)(L-N/N-PE) $I_{limp}$	7kA/12.5kA	7kA/12.5kA	7kA/12.5kA
Total discharge current (10/350 $\mu$ s) $I_{total}$	14kA	14kA	14kA
Nominal discharge current (8/20 $\mu$ s) (L-N/N-PE) $I_n$	20kA/40kA	20kA/40kA	20kA/40kA
Max. discharge current (8/20 $\mu$ s) (L-N/N-PE) $I_{max}$	50kA/80kA	50kA/80kA	50kA/80kA
Voltage protection level (L-N/N-PE) $U_p$	$\leq 0.8kV/\leq 1.5kV$	$\leq 1.3kV/\leq 1.5kV$	$\leq 1.5kV/\leq 1.5kV$
Voltage protection level 5kA (L-N/N-PE) $U_p$	$\leq 0.6kV/\leq 1.5kV$	$\leq 1kV/\leq 1.5kV$	$\leq 1.2kV/\leq 1.5kV$
Max. backup fuse	125A gG	125A gG	125A gG
Specific energy (L-N/N-PE) $W/R$	12.25kJ/ $\Omega$ /39kJ/ $\Omega$	12.25kJ/ $\Omega$ /39kJ/ $\Omega$	12.25kJ/ $\Omega$ /39kJ/ $\Omega$
Short circuit withstand capacity $I_{SCCR}$	25kA	25kA	25kA
Temporary overvoltage TOV-withstand (L-N) $U_T$	180V/5sec.	335V/5sec.	400V/5sec.
Temporary overvoltage TOV-safe failure (L-N) $U_T$	230V/120min.	440V/120min.	520V/120min.
Temporary overvoltage TOV-withstand (N-PE) $U_T$	1200V/200ms	1200V/200ms	1200V/200ms
Leakage current $I_{PE}$	None	None	None
Response time (L-N/N-PE) $t_A$	$\leq 25ns/\leq 100ns$	$\leq 25ns/\leq 100ns$	$\leq 25ns/\leq 100ns$
Operating temperature range $T_u$	-40 $^{\circ}C$ -80 $^{\circ}C$	-40 $^{\circ}C$ -80 $^{\circ}C$	-40 $^{\circ}C$ -80 $^{\circ}C$
Operating state/fault indication	green/red	green/red	green/red
Cross-section area (Min.)	4 mm <sup>2</sup>	4 mm <sup>2</sup>	4 mm <sup>2</sup>
Cross-section area (Max.)	35mm <sup>2</sup>	35mm <sup>2</sup>	35mm <sup>2</sup>
For mounting on	35mm Din rail		
Enclosure material	Thermoplastic UL94-V0		
Degree of protection	IP20	IP20	IP20
Order Code	B17330	B17332	B17334
Order Code (With remote signaling)	B17331	B17333	B17335



Red:Replace  
**BRITEC**  
Surge Arrester  
**BR-40**  
Uc: 275V~  
In: 20kA T2  
Imax: 40kA  
Up: 1.3kV  
IEC61643-11 CE

Red:Replace  
**BRITEC**  
Surge Arrester  
**BR-40**  
Uc: 275V~  
In: 20kA T2  
Imax: 40kA  
Up: 1.3kV  
IEC61643-11 CE

Red:Replace  
**BRITEC**  
Surge Arrester  
**BR-40**  
Uc: 275V~  
In: 20kA T2  
Imax: 40kA  
Up: 1.3kV  
IEC61643-11 CE

Red:Replace  
**BRITEC**  
Surge Arrester  
**BR-40**  
Uc: 275V~  
In: 20kA T2  
Imax: 40kA  
Up: 1.3kV  
IEC61643-11 CE

PE

## Type 2 Surge Arrester

## BR-110 4P

### Type 2 Surge Arrester

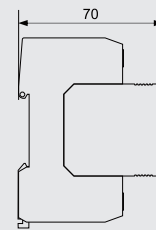
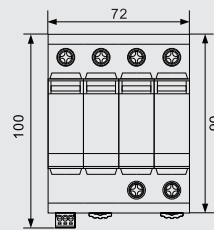
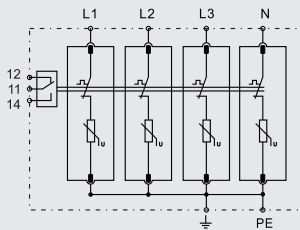

■ BR-110 4pole surge arrester is suitable for TN-S system.

	BR-110 275 4P	BR-110 320 4P	BR-110 385 4P
SPD classification according to EN61643-11	Type 2	Type 2	Type 2
SPD classification according to IEC61643-11	Class II	Class II	Class II
Max. continuous operating a.c. voltage $U_c$	275V	320V	385V
Nominal discharge current (8/20 $\mu$ s) $I_n$	50kA	50kA	50kA
Max. discharge current (8/20 $\mu$ s) $I_{max}$	110kA	110kA	110kA
Voltage protection level $U_p$	$\leq 1.8kV$	$\leq 2.0kV$	$\leq 2.5kV$
Voltage protection level 5kA $U_p$	$\leq 1kV$	$\leq 1.1kV$	$\leq 1.2kV$
Max. backup fuse	160A gG	160A gG	160A gG
Short-circuit withstand capacity $I_{SCCR}$	25kA	25kA	25kA
Temporary overvoltage TOV-withstand $U_T$	335V/5sec.	400V/5sec.	500V/5sec.
Temporary overvoltage TOV-safe failure $U_T$	440V/120min.	520V/120min.	650V/120min.
Leakage current $I_{PE}$	$< 0.5mA$	$< 0.5mA$	$< 0.5mA$
Response time $t_A$	$\leq 25ns$	$\leq 25ns$	$\leq 25ns$
Operating temperature range $T_u$	$-40^{\circ}C - 80^{\circ}C$	$-40^{\circ}C - 80^{\circ}C$	$-40^{\circ}C - 80^{\circ}C$
Operating state/fault indication	green/red	green/red	green/red
Cross-section area (Min.)	4 mm <sup>2</sup>	4 mm <sup>2</sup>	4 mm <sup>2</sup>
Cross-section area (Max.)	35mm <sup>2</sup>	35mm <sup>2</sup>	35mm <sup>2</sup>
For mounting on	35mm Din rail		
Enclosure material	Thermoplastic UL94-V0		
Degree of protection	IP20	IP20	IP20
Order Code	B18823	B18825	B18827
Order Code (With remote signaling)	B18824	B18826	B18828

## BR-110 3P

Type 2 Surge Arrester

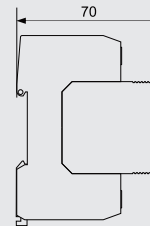
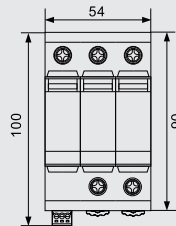
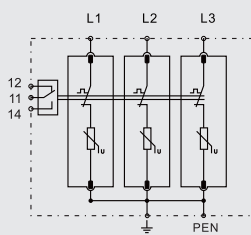

BR-110 3pole surge arrester is suitable for TN-C system.

	BR-110 275 3P	BR-110 320 3P	BR-110 385 3P
SPD classification according to EN61643-11	Type 2	Type 2	Type 2
SPD classification according to IEC61643-11	Class II	Class II	Class II
Max. continuous operating a.c. voltage $U_c$	275V	320V	385V
Nominal discharge current (8/20 $\mu$ s) $I_n$	50kA	50kA	50kA
Max. discharge current (8/20 $\mu$ s) $I_{max}$	110kA	110kA	110kA
Voltage protection level $U_p$	$\leq 1.8kV$	$\leq 2.0kV$	$\leq 2.5kV$
Voltage protection level 5kA $U_{p5kA}$	$\leq 1kV$	$\leq 1.1kV$	$\leq 1.2kV$
Max. backup fuse	160A gG	160A gG	160A gG
Short-circuit withstand capacity $I_{SCCR}$	25kA	25kA	25kA
Temporary overvoltage TOV-withstand $U_T$	335V/5sec.	400V/5sec.	500V/5sec.
Temporary overvoltage TOV-safe failure $U_T$	440V/120min.	520V/120min.	650V/120min.
Leakage current $I_{PE}$	$< 0.5mA$	$< 0.5mA$	$< 0.5mA$
Response time $t_A$	$\leq 25ns$	$\leq 25ns$	$\leq 25ns$
Operating temperature range $T_u$	$-40^{\circ}C$ – $80^{\circ}C$	$-40^{\circ}C$ – $80^{\circ}C$	$-40^{\circ}C$ – $80^{\circ}C$
Operating state/fault indication	green/red	green/red	green/red
Cross-section area (Min.)	4 mm <sup>2</sup>	4 mm <sup>2</sup>	4 mm <sup>2</sup>
Cross-section area (Max.)	35mm <sup>2</sup>	35mm <sup>2</sup>	35mm <sup>2</sup>
For mounting on	35mm Din rail		
Enclosure material	Thermoplastic UL94-V0		
Degree of protection	IP20	IP20	IP20
Order Code	B18833	B18835	B18837
Order Code (With remote signaling)	B18834	B18836	B18838

## BR-110 2P

### Type 2 Surge Arrester

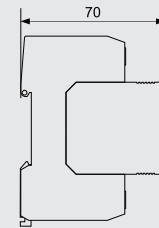
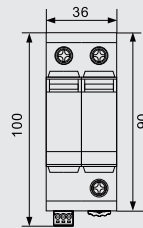
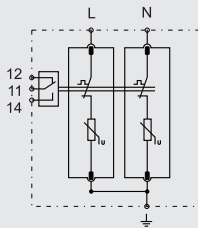

■ BR-110 2pole surge arrester is suitable for single phase TN system.

		BR-110 275 2P	BR-110 320 2P	BR-110 385 2P
SPD classification according to EN61643-11		Type 2	Type 2	Type 2
SPD classification according to IEC61643-11		Class II	Class II	Class II
Max. continuous operating a.c. voltage	U <sub>c</sub>	275V	320V	385V
Nominal discharge current (8/20μs)	I <sub>n</sub>	50kA	50kA	50kA
Max. discharge current (8/20μs)	I <sub>max</sub>	110kA	110kA	110kA
Voltage protection level	U <sub>p</sub>	≤1.8kV	≤2.0kV	≤2.5kV
Voltage protection level 5kA	U <sub>p</sub>	≤1kV	≤1.1kV	≤1.2kV
Max. backup fuse		160A gG	160A gG	160A gG
Short-circuit withstand capacity	I <sub>SCCR</sub>	25kA	25kA	25kA
Temporary overvoltage TOV-withstand	U <sub>T</sub>	335V/5sec.	400V/5sec.	500V/5sec.
Temporary overvoltage TOV-safe failure	U <sub>T</sub>	440V/120min.	520V/120min.	650V/120min.
Leakage current	I <sub>PE</sub>	<1mA	<1mA	<1mA
Response time	t <sub>A</sub>	≤25ns	≤25ns	≤25ns
Operating temperature range	T <sub>u</sub>	-40°C-80°C	-40°C-80°C	-40°C-80°C
Operating state/fault indication		green/red	green/red	green/red
Cross-section area (Min.)		4 mm <sup>2</sup>	4 mm <sup>2</sup>	4 mm <sup>2</sup>
Cross-section area (Max.)		35mm <sup>2</sup>	35mm <sup>2</sup>	35mm <sup>2</sup>
For mounting on		35mm Din rail		
Enclosure material		Thermoplastic UL94-V0		
Degree of protection		IP20	IP20	IP20
Order Code		B18843	B18845	B18847
Order Code (With remote signaling)		B18844	B18846	B18848

## BR-110 1P

Type 2 Surge Arrester

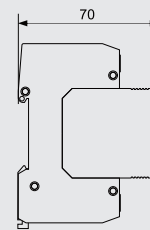
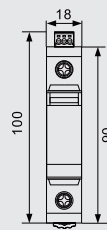
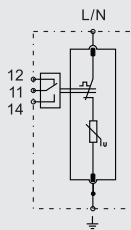

■ BR-110 1pole can be used to build 2P, 3P and 4P surge arresters.

		BR-110 275 1P	BR-110 320 1P	BR-110 385 1P
SPD classification according to EN61643-11		Type 2	Type 2	Type 2
SPD classification according to IEC61643-11		Class II	Class II	Class II
Max. continuous operating a.c. voltage	U <sub>c</sub>	275V	320V	385V
Nominal discharge current (8/20μs)	I <sub>n</sub>	50kA	50kA	50kA
Max. discharge current (8/20μs)	I <sub>max</sub>	110kA	110kA	110kA
Voltage protection level	U <sub>p</sub>	≤1.8kV	≤2.0kV	≤2.5kV
Voltage protection level 5kA	U <sub>p</sub>	≤1kV	≤1.1kV	≤1.2kV
Max. backup fuse		160A gG	160A gG	160A gG
Short-circuit withstand capacity	I <sub>SCCR</sub>	25kA	25kA	25kA
Temporary overvoltage TOV-withstand	U <sub>T</sub>	335V/5sec.	400V/5sec.	500V/5sec.
Temporary overvoltage TOV-safe failure	U <sub>T</sub>	440V/120min.	520V/120min.	650V/120min.
Leakage current	I <sub>PE</sub>	<1mA	<1mA	<1mA
Response time	t <sub>A</sub>	≤25ns	≤25ns	≤25ns
Operating temperature range	T <sub>u</sub>	-40°C-80°C	-40°C-80°C	-40°C-80°C
Operating state/fault indication		green/red	green/red	green/red
Cross-section area (Min.)		4 mm <sup>2</sup>	4 mm <sup>2</sup>	4 mm <sup>2</sup>
Cross-section area (Max.)		35mm <sup>2</sup>	35mm <sup>2</sup>	35mm <sup>2</sup>
For mounting on		35mm Din rail		
Enclosure material		Thermoplastic UL94-V0		
Degree of protection		IP20	IP20	IP20
Order Code		B18853	B18855	B18857
Order Code (With remote signaling)		B18854	B18856	B18858

## BR-110 3+1

### Type 2 Surge Arrester

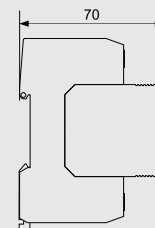
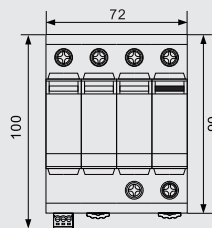
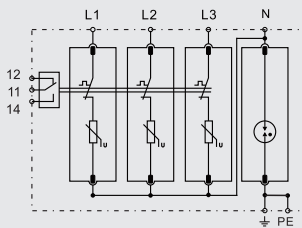

BR-110 3+1 surge arrester is suitable for TT and TN-S system.

	BR-110 275 3+1	BR-110 320 3+1	BR-110 385 3+1
SPD classification according to EN61643-11	Type 2	Type 2	Type 2
SPD classification according to IEC61643-11	Class II	Class II	Class II
Max. continuous operating a.c. voltage [L-N] U <sub>c</sub>	275V	320V	385V
Max. continuous operating a.c. voltage [N-PE] U <sub>c</sub>	255V	255V	255V
Nominal discharge current (8/20μs) I <sub>n</sub>	50kA	50kA	50kA
Max. discharge current (8/20μs) I <sub>max</sub>	110kA	110kA	110kA
Voltage protection level [L-N] U <sub>p</sub>	≤1.8kV	≤2.0kV	≤2.5kV
Voltage protection level 5kA [L-N] U <sub>p</sub>	≤1kV	≤1.1kV	≤1.2kV
Voltage protection level [N-PE] U <sub>p</sub>	≤1.5kV	≤1.5kV	≤1.5kV
Short-circuit withstand capacity I <sub>SCCR</sub>	25kA	25kA	25kA
Temporary overvoltage TOV-withstand [L-N] U <sub>T</sub>	335V/5sec.	400V/5sec.	500V/5sec.
Temporary overvoltage TOV-safe failure [L-N] U <sub>T</sub>	440V/120min.	520V/120min.	650V/120min.
Temporary overvoltage TOV-withstand [N-PE] U <sub>T</sub>	1200V/200ms	1200V/200ms	1200V/200ms
Follow current extinguishing capability a.c. [N-PE] I <sub>fi</sub>	100Arms	100Arms	100Arms
Max. backup fuse	160A gG	160A gG	160A gG
Leakage current I <sub>PE</sub>	None	None	None
Response time [L-N] t <sub>A</sub>	≤25ns	≤25ns	≤25ns
Response time [N-PE] t <sub>A</sub>	≤100ns	≤100ns	≤100ns
Operating temperature range T <sub>u</sub>	-40°C-80°C	-40°C-80°C	-40°C-80°C
Operating state/fault indication	green/red	green/red	green/red
Cross-section area (Min.)	4 mm <sup>2</sup>	4 mm <sup>2</sup>	4 mm <sup>2</sup>
Cross-section area (Max.)	35mm <sup>2</sup>	35mm <sup>2</sup>	35mm <sup>2</sup>
For mounting on	35mm Din rail		
Enclosure material	Thermoplastic UL94-V0		
Degree of protection	IP20	IP20	IP20
Order Code	B18863	B18865	B18867
Order Code (With remote signaling)	B18864	B18866	B18868

## BR-110 1+1

### Type 2 Surge Arrester

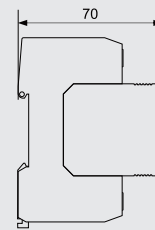
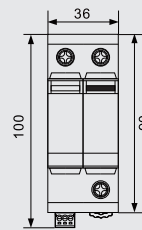
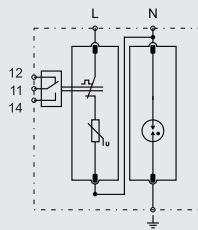

■ BR-110 1+1 surge arrester is suitable for single phase TT and TN system.

	BR-110 275 1+1	BR-110 320 1+1	BR-110 385 1+1
SPD classification according to EN61643-11	Type 2	Type 2	Type 2
SPD classification according to IEC61643-11	Class II	Class II	Class II
Max. continuous operating a.c. voltage [L-N] U <sub>c</sub>	275V	320V	385V
Max. continuous operating a.c. voltage [N-PE] U <sub>c</sub>	255V	255V	255V
Nominal discharge current (8/20μs) I <sub>n</sub>	50kA	50kA	50kA
Max. discharge current (8/20μs) I <sub>max</sub>	110kA	110kA	110kA
Voltage protection level [L-N] U <sub>p</sub>	≤1.8kV	≤2.0kV	≤2.5kV
Voltage protection level 5kA [L-N] U <sub>p</sub>	≤1kV	≤1.1kV	≤1.2kV
Voltage protection level [N-PE] U <sub>p</sub>	≤1.5kV	≤1.5kV	≤1.5kV
Short-circuit withstand capacity I <sub>SCCR</sub>	25kA	25kA	25kA
Temporary overvoltage TOV-withstand [L-N] U <sub>T</sub>	335V/5sec.	400V/5sec.	550V/5sec.
Temporary overvoltage TOV-safe failure [L-N] U <sub>T</sub>	440V/120min.	520V/120min.	650V/120min.
Temporary overvoltage TOV-withstand [N-PE] U <sub>T</sub>	1200V/200ms	1200V/200ms	1200V/200ms
Follow current extinguishing capability a.c. [N-PE] I <sub>fi</sub>	100Arms	100Arms	100Arms
Max. backup fuse	160A gG	160A gG	160A gG
Leakage current I <sub>PE</sub>	None	None	None
Response time [L-N] t <sub>A</sub>	≤25ns	≤25ns	≤25ns
Response time [N-PE] t <sub>A</sub>	≤100ns	≤100ns	≤100ns
Operating temperature range T <sub>u</sub>	-40°C-80°C	-40°C-80°C	-40°C-80°C
Operating state/fault indication	green/red	green/red	green/red
Cross-section area (Min.)	4 mm <sup>2</sup>	4 mm <sup>2</sup>	4 mm <sup>2</sup>
Cross-section area (Max.)	35mm <sup>2</sup>	35mm <sup>2</sup>	35mm <sup>2</sup>
For mounting on	35mm Din rail		
Enclosure material	Thermoplastic UL94-V0		
Degree of protection	IP20	IP20	IP20
Order Code	B18873	B18875	B18877
Order Code (With remote signaling)	B18874	B18876	B18878

## BR-80 4P

### Type 2 Surge Arrester

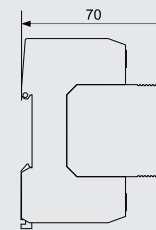
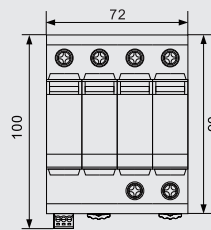
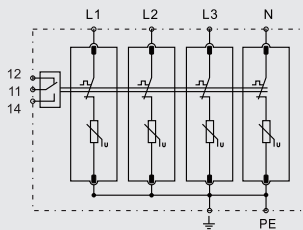
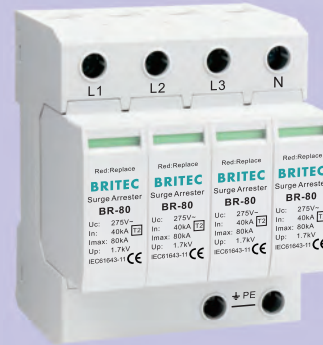

BR-80 4 pole surge arrester is suitable for TN-S system.

	BR-80 150 4P	BR-80 275 4P	BR-80 320 4P	BR-80 385 4P
SPD classification according to EN61643-11	Type 2	Type 2	Type 2	Type 2
SPD classification according to IEC61643-11	Class II	Class II	Class II	Class II
Max. continuous operating a.c. voltage	Uc	150V	275V	320V
Nominal discharge current (8/20μs)	In	40kA	40kA	40kA
Max. discharge current (8/20μs)	I <sub>max</sub>	80kA	80kA	80kA
Voltage protection level	Up	≤1.0kV	≤1.7kV	≤2.0kV
Voltage protection level 5kA	Up	≤0.6kV	≤1kV	≤1.1kV
Max. backup fuse		160A gG	160A gG	160A gG
Short-circuit withstand capacity	I <sub>SCCR</sub>	25kA	25kA	25kA
Temporary overvoltage TOV-withstand	U <sub>T</sub>	180V/5sec.	335V/5sec.	400V/5sec.
Temporary overvoltage TOV-safe failure	U <sub>T</sub>	230V/120min.	440V/120min.	520V/120min.
Leakage current	I <sub>PE</sub>	<0.5mA	<0.5mA	<0.5mA
Response time	t <sub>A</sub>	≤25ns	≤25ns	≤25ns
Operating temperature range	T <sub>u</sub>	-40°C-80°C	-40°C-80°C	-40°C-80°C
Operating state/fault indication		green/red	green/red	green/red
Cross-section area (Min.)		4 mm <sup>2</sup>	4 mm <sup>2</sup>	4 mm <sup>2</sup>
Cross-section area (Max.)		35mm <sup>2</sup>	35mm <sup>2</sup>	35mm <sup>2</sup>
For mounting on	35mm Din rail			
Enclosure material	Thermoplastic UL94-V0			
Degree of protection	IP20	IP20	IP20	IP20
Order Code	B18260	B18262	B18264	B18266
Order Code (With remote signaling)	B18261	B18263	B18265	B18267

## BR-80 3P

### Type 2 Surge Arrester

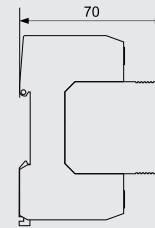
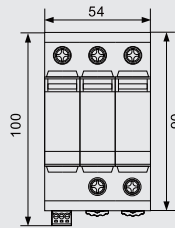
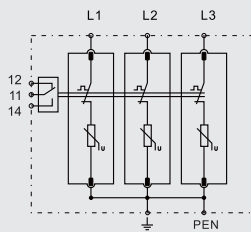
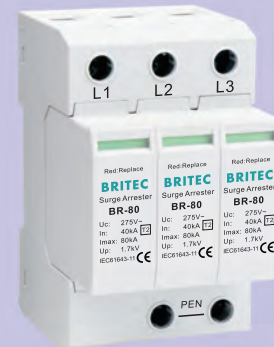

■ BR-80 3 pole surge arrester is suitable for TN-C system.

	BR-80 150 3P	BR-80 275 3P	BR-80 320 3P	BR-80 385 3P
SPD classification according to EN61643-11	Type 2	Type 2	Type 2	Type 2
SPD classification according to IEC61643-11	Class II	Class II	Class II	Class II
Max. continuous operating a.c. voltage	U <sub>c</sub>	150V	275V	320V
Nominal discharge current (8/20μs)	I <sub>n</sub>	40kA	40kA	40kA
Max. discharge current (8/20μs)	I <sub>max</sub>	80kA	80kA	80kA
Voltage protection level	U <sub>p</sub>	≤1.0kV	≤1.7kV	≤2.0kV
Voltage protection level 5kA	U <sub>p</sub>	≤0.6kV	≤1kV	≤1.1kV
Max. backup fuse		160A gG	160A gG	160A gG
Short-circuit withstand capacity	I <sub>SCCR</sub>	25kA	25kA	25kA
Temporary overvoltage TOV-withstand	U <sub>T</sub>	180V/5sec.	335V/5sec.	400V/5sec.
Temporary overvoltage TOV-safe failure	U <sub>T</sub>	230V/120min.	440V/120min.	520V/120min.
Leakage current	I <sub>PE</sub>	<0.5mA	<0.5mA	<0.5mA
Response time	t <sub>A</sub>	≤25ns	≤25ns	≤25ns
Operating temperature range	T <sub>u</sub>	-40°C-80°C	-40°C-80°C	-40°C-80°C
Operating state/fault indication		green/red	green/red	green/red
Cross-section area (Min.)		4 mm <sup>2</sup>	4 mm <sup>2</sup>	4 mm <sup>2</sup>
Cross-section area (Max.)		35mm <sup>2</sup>	35mm <sup>2</sup>	35mm <sup>2</sup>
For mounting on	35mm Din rail			
Enclosure material	Thermoplastic UL94-V0			
Degree of protection	IP20	IP20	IP20	IP20
Order Code	B18268	B18270	B18272	B18274
Order Code (With remote signaling)	B18269	B18271	B18273	B18275

## BR-80 2P

### Type 2 Surge Arrester

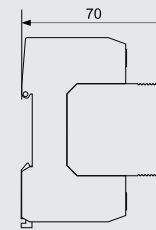
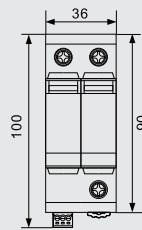
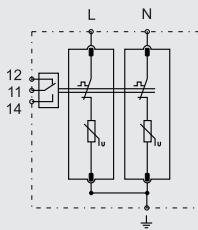
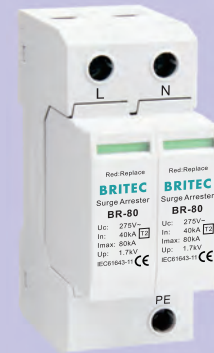

■ BR-80 2 pole surge arrester is suitable for single phase TN system.

	BR-80 150 2P	BR-80 275 2P	BR-80 320 2P	BR-80 385 2P
SPD classification according to EN61643-11	Type 2	Type 2	Type 2	Type 2
SPD classification according to IEC61643-11	Class II	Class II	Class II	Class II
Max. continuous operating a.c. voltage	$U_c$	150V	275V	320V
Nominal discharge current (8/20 $\mu$ s)	$I_n$	40kA	40kA	40kA
Max. discharge current (8/20 $\mu$ s)	$I_{max}$	80kA	80kA	80kA
Voltage protection level	$U_p$	$\leq 1.0kV$	$\leq 1.7kV$	$\leq 2.0kV$
Voltage protection level 5kA	$U_p$	$\leq 0.6kV$	$\leq 1kV$	$\leq 1.1kV$
Max. backup fuse		160A gG	160A gG	160A gG
Short-circuit withstand capacity	$I_{SCCR}$	25kA	25kA	25kA
Temporary overvoltage TOV-withstand	$U_T$	180V/5sec.	335V/5sec.	400V/5sec.
Temporary overvoltage TOV-safe failure	$U_T$	230V/120min.	440V/120min.	520V/120min.
Leakage current	$I_{PE}$	<1mA	<1mA	<1mA
Response time	$t_A$	$\leq 25ns$	$\leq 25ns$	$\leq 25ns$
Operating temperature range	$T_u$	-40 $^{\circ}C$ -80 $^{\circ}C$	-40 $^{\circ}C$ -80 $^{\circ}C$	-40 $^{\circ}C$ -80 $^{\circ}C$
Operating state/fault indication		green/red	green/red	green/red
Cross-section area (Min.)		4 mm <sup>2</sup>	4 mm <sup>2</sup>	4 mm <sup>2</sup>
Cross-section area (Max.)		35mm <sup>2</sup>	35mm <sup>2</sup>	35mm <sup>2</sup>
For mounting on	35mm Din rail			
Enclosure material	Thermoplastic UL94-V0			
Degree of protection	IP20	IP20	IP20	IP20
Order Code	B18276	B18278	B18280	B18282
Order Code (With remote signaling)	B18277	B18279	B18281	B18283

## BR-80 1P

Type 2 Surge Arrester

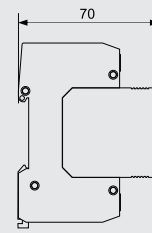
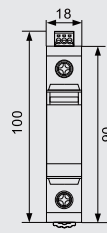
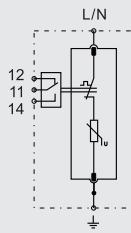

BR-80 1P can be used to build 2P, 3P and 4P surge arresters.

		BR-80 150 1P	BR-80 275 1P	BR-80 320 1P	BR-80 385 1P
SPD classification according to EN61643-11		Type 2	Type 2	Type 2	Type 2
SPD classification according to IEC61643-11		Class II	Class II	Class II	Class II
Max. continuous operating a.c. voltage	U <sub>c</sub>	150V	275V	320V	385V
Nominal discharge current (8/20μs)	I <sub>n</sub>	40kA	40kA	40kA	40kA
Max. discharge current (8/20μs)	I <sub>max</sub>	80kA	80kA	80kA	80kA
Voltage protection level	U <sub>p</sub>	≤1.0kV	≤1.7kV	≤2.0kV	≤2.3kV
Voltage protection level 5kA	U <sub>p</sub>	≤0.6kV	≤1kV	≤1.1kV	≤1.2kV
Max. backup fuse		160A gG	160A gG	160A gG	160A gG
Short-circuit withstand capacity	I <sub>SCCR</sub>	25kA	25kA	25kA	25kA
Temporary overvoltage TOV-withstand	U <sub>T</sub>	180V/5sec.	335V/5sec.	400V/5sec.	500V/5sec.
Temporary overvoltage TOV-safe failure	U <sub>T</sub>	230V/120min.	440V/120min.	520V/120min.	650V/120min.
Leakage current	I <sub>PE</sub>	<1mA	<1mA	<1mA	<1mA
Response time	t <sub>A</sub>	≤25ns	≤25ns	≤25ns	≤25ns
Operating temperature range	T <sub>u</sub>	-40°C-80°C	-40°C-80°C	-40°C-80°C	-40°C-80°C
Operating state/fault indication		green/red	green/red	green/red	green/red
Cross-section area (Min.)		4 mm <sup>2</sup>	4 mm <sup>2</sup>	4 mm <sup>2</sup>	4 mm <sup>2</sup>
Cross-section area (Max.)		35mm <sup>2</sup>	35mm <sup>2</sup>	35mm <sup>2</sup>	35mm <sup>2</sup>
For mounting on		35mm Din rail			
Enclosure material		Thermoplastic UL94-V0			
Degree of protection		IP20	IP20	IP20	IP20
Order Code		B18284	B18286	B18288	B18290
Order Code (With remote signaling)		B18285	B18287	B18289	B18291

## BR-80 3+1

### Type 2 Surge Arrester

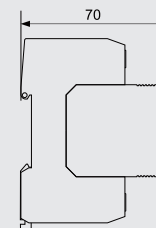
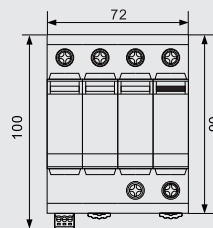
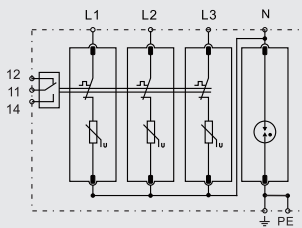

BR-80 3+1 surge arrester is suitable for TT and TN-S system.

	BR-80 150 3+1	BR-80 275 3+1	BR-80 320 3+1	BR-80 385 3+1
SPD classification according to EN61643-11	Type 2	Type 2	Type 2	Type 2
SPD classification according to IEC61643-11	Class II	Class II	Class II	Class II
Max. continuous operating a.c. voltage [L-N] U <sub>c</sub>	150V	275V	320V	385V
Max. continuous operating a.c. voltage [N-PE] U <sub>c</sub>	255V	255V	255V	255V
Nominal discharge current (8/20μs) I <sub>n</sub>	40kA	40kA	40kA	40kA
Max. discharge current (8/20μs) I <sub>max</sub>	80kA	80kA	80kA	80kA
Voltage protection level [L-N] U <sub>p</sub>	≤1.0kV	≤1.7kV	≤2.0kV	≤2.3kV
Voltage protection level 5kA [L-N] U <sub>p</sub>	≤0.6kV	≤1kV	≤1.1kV	≤1.2kV
Voltage protection level [N-PE] U <sub>p</sub>	≤1.5kV	≤1.5kV	≤1.5kV	≤1.5kV
Short-circuit withstand capacity I <sub>SCCR</sub>	25kA	25kA	25kA	25kA
Temporary overvoltage TOV-withstand [L-N] U <sub>T</sub>	180V/5sec.	335V/5sec.	400V/5sec.	500V/5sec.
Temporary overvoltage TOV-safe failure [L-N] U <sub>T</sub>	230V/120min.	440V/120min.	520V/120min.	650V/120min.
Temporary overvoltage TOV-withstand [N-PE] U <sub>T</sub>	1200V/200ms	1200V/200ms	1200V/200ms	1200V/200ms
Follow current extinguishing capability a.c. [N-PE] I <sub>fi</sub>	100Arms	100Arms	100Arms	100Arms
Max. backup fuse	160A gG	160A gG	160A gG	160A gG
Leakage current I <sub>PE</sub>	None	None	None	None
Response time [L-N] t <sub>A</sub>	≤25ns	≤25ns	≤25ns	≤25ns
Response time [N-PE] t <sub>A</sub>	≤100ns	≤100ns	≤100ns	≤100ns
Operating temperature range T <sub>u</sub>	-40°C-80°C	-40°C-80°C	-40°C-80°C	-40°C-80°C
Operating state/fault indication	green/red	green/red	green/red	green/red
Cross-section area (Min.)	4 mm <sup>2</sup>	4 mm <sup>2</sup>	4 mm <sup>2</sup>	4 mm <sup>2</sup>
Cross-section area (Max.)	35mm <sup>2</sup>	35mm <sup>2</sup>	35mm <sup>2</sup>	35mm <sup>2</sup>
For mounting on	35mm Din rail			
Enclosure material	Thermoplastic UL94-V0			
Degree of protection	IP20	IP20	IP20	IP20
Order Code	B18292	B18294	B18296	B18298
Order Code (With remote signaling)	B18293	B18295	B18297	B18888

## BR-80 1+1

### Type 2 Surge Arrester

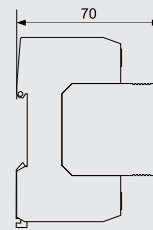
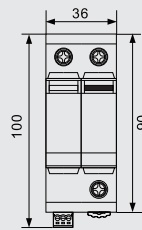
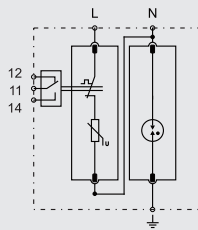
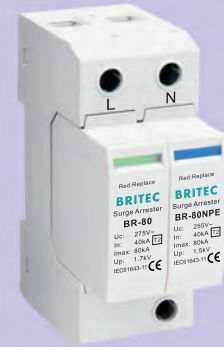

BR-80 1+1 surge arrester is suitable for single phase TT and TN system.

	BR-80 150 1+1	BR-80 275 1+1	BR-80 320 1+1	BR-80 385 1+1
SPD classification according to EN61643-11	Type 2	Type 2	Type 2	Type 2
SPD classification according to IEC61643-11	Class II	Class II	Class II	Class II
Max. continuous operating a.c. voltage [L-N] U <sub>c</sub>	150V	275V	320V	385V
Max. continuous operating a.c. voltage [N-PE] U <sub>c</sub>	255V	255V	255V	255V
Nominal discharge current (8/20μs) I <sub>n</sub>	40kA	40kA	40kA	40kA
Max. discharge current (8/20μs) I <sub>max</sub>	80kA	80kA	80kA	80kA
Voltage protection level [L-N] U <sub>p</sub>	≤1.0kV	≤1.7kV	≤2.0kV	≤2.3kV
Voltage protection level 5kA [L-N] U <sub>p</sub>	≤0.6kV	≤1kV	≤1.1kV	≤1.2kV
Voltage protection level [N-PE] U <sub>p</sub>	≤1.5kV	≤1.5kV	≤1.5kV	≤1.5kV
Short-circuit withstand capacity I <sub>SCCR</sub>	25kA	25kA	25kA	25kA
Temporary overvoltage TOV-withstand [L-N] U <sub>T</sub>	180V/5sec.	335V/5sec.	400V/5sec.	500V/5sec.
Temporary overvoltage TOV-safe failure [L-N] U <sub>T</sub>	230V/120min.	440V/120min.	520V/120min.	650V/120min.
Temporary overvoltage TOV-withstand [N-PE] U <sub>T</sub>	1200V/200ms	1200V/200ms	1200V/200ms	1200V/200ms
Follow current extinguishing capability a.c. [N-PE] I <sub>fi</sub>	100Arms	100Arms	100Arms	100Arms
Max. backup fuse	160A gG	160A gG	160A gG	160A gG
Leakage current I <sub>PE</sub>	None	None	None	None
Response time [L-N] t <sub>A</sub>	≤25ns	≤25ns	≤25ns	≤25ns
Response time [N-PE] t <sub>A</sub>	≤100ns	≤100ns	≤100ns	≤100ns
Operating temperature range T <sub>u</sub>	-40°C-80°C	-40°C-80°C	-40°C-80°C	-40°C-80°C
Operating state/fault indication	green/red	green/red	green/red	green/red
Cross-section area (Min.)	4 mm <sup>2</sup>	4 mm <sup>2</sup>	4 mm <sup>2</sup>	4 mm <sup>2</sup>
Cross-section area (Max.)	35mm <sup>2</sup>	35mm <sup>2</sup>	35mm <sup>2</sup>	35mm <sup>2</sup>
For mounting on	35mm Din rail			
Enclosure material	Thermoplastic UL94-V0			
Degree of protection	IP20	IP20	IP20	IP20
Order Code	B18360	B18362	B18364	B18366
Order Code (With remote signaling)	B18361	B18363	B18365	B18367

## BR-40 4P

### Type 2 Surge Arrester

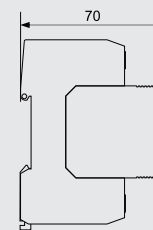
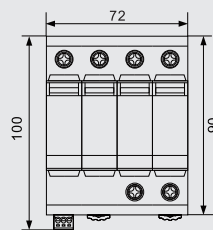
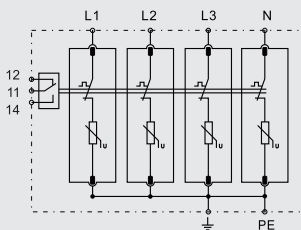
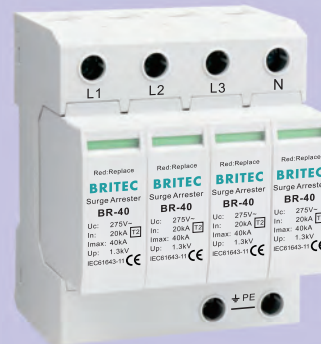

BR-40 4 pole surge arrester is suitable for TN-S system.

	BR-40 150 4P	BR-40 275 4P	BR-40 320 4P	BR-40 385 4P	BR-40 440 4P
SPD classification according to EN61643-11	Type 2	Type 2	Type 2	Type 2	Type 2
SPD classification according to IEC61643-11	Class II	Class II	Class II	Class II	Class II
Max. continuous operating a.c. voltage $U_c$	150V	275V	320V	385V	440V
Nominal discharge current (8/20 $\mu$ s) $I_n$	20kA	20kA	20kA	20kA	20kA
Max. discharge current (8/20 $\mu$ s) $I_{max}$	40kA	40kA	40kA	40kA	40kA
Voltage protection level $U_p$	$\leq 0.8kV$	$\leq 1.3kV$	$\leq 1.5kV$	$\leq 1.8kV$	$\leq 2.0kV$
Voltage protection level 5kA $U_p$	$\leq 0.6kV$	$\leq 1kV$	$\leq 1.2kV$	$\leq 1.3kV$	$\leq 1.5kV$
Max. backup fuse	100A gG	100A gG	100A gG	100A gG	100A gG
Short-circuit withstand capacity $I_{SCCR}$	25kA	25kA	25kA	25kA	25kA
Temporary overvoltage TOV-withstand $U_T$	180V/5sec.	335V/5sec.	400V/5sec.	500V/5sec.	580V/5sec.
Temporary overvoltage TOV-safe failure $U_T$	230V/120min.	440V/120min.	520V/120min.	650V/120min.	765V/120min.
Leakage current $I_{PE}$	$< 0.5mA$	$< 0.5mA$	$< 0.5mA$	$< 0.5mA$	$< 0.5mA$
Response time $t_A$	$\leq 25ns$	$\leq 25ns$	$\leq 25ns$	$\leq 25ns$	$\leq 25ns$
Operating temperature range $T_u$	$-40^{\circ}C-80^{\circ}C$	$-40^{\circ}C-80^{\circ}C$	$-40^{\circ}C-80^{\circ}C$	$-40^{\circ}C-80^{\circ}C$	$-40^{\circ}C-80^{\circ}C$
Operating state/fault indication	green/red	green/red	green/red	green/red	green/red
Cross-section area (Min.)	4 mm <sup>2</sup>	4 mm <sup>2</sup>	4 mm <sup>2</sup>	4 mm <sup>2</sup>	4 mm <sup>2</sup>
Cross-section area (Max.)	35mm <sup>2</sup>	35mm <sup>2</sup>	35mm <sup>2</sup>	35mm <sup>2</sup>	35mm <sup>2</sup>
For mounting on	35mm Din rail				
Enclosure material	Thermoplastic UL94-V0				
Degree of protection	IP20	IP20	IP20	IP20	IP20
Order Code	B18401	B18403	B18405	B18407	B18409
Order Code (With remote signaling)	B18402	B18404	B18406	B18408	B18410

## BR-40 3P

### Type 2 Surge Arrester

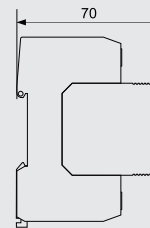
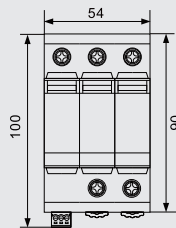
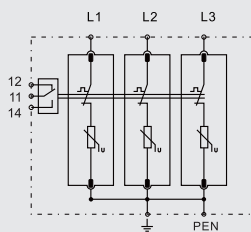
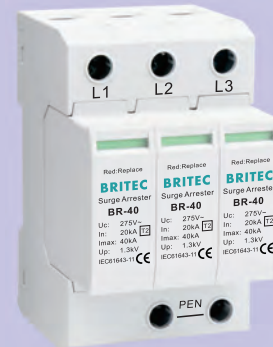

■ BR-40 3 pole surge arrester is suitable for TN-C system.

	BR-40 150 3P	BR-40 275 3P	BR-40 320 3P	BR-40 385 3P	BR-40 440 3P	
SPD classification according to EN61643-11	Type 2	Type 2	Type 2	Type 2	Type 2	
SPD classification according to IEC61643-11	Class II	Class II	Class II	Class II	Class II	
Max. continuous operating a.c. voltage	Uc	150V	275V	320V	385V	440V
Nominal discharge current (8/20µs)	In	20kA	20kA	20kA	20kA	20kA
Max. discharge current (8/20µs)	Imax	40kA	40kA	40kA	40kA	40kA
Voltage protection level	Up	≤0.8kV	≤1.3kV	≤1.5kV	≤1.8kV	≤2.0kV
Voltage protection level 5kA	Up	≤0.6kV	≤1kV	≤1.2kV	≤1.3kV	≤1.5kV
Max. backup fuse		100A gG	100A gG	100A gG	100A gG	100A gG
Short-circuit withstand capacity	ISCCR	25kA	25kA	25kA	25kA	25kA
Temporary overvoltage TOV-withstand	UT	180V/5sec.	335V/5sec.	400V/5sec.	500V/5sec.	580V/5sec.
Temporary overvoltage TOV-safe failure	UT	230V/120min.	440V/120min.	520V/120min.	650V/120min.	765V/120min.
Leakage current	IE	<0.5mA	<0.5mA	<0.5mA	<0.5mA	<0.5mA
Response time	tA	≤25ns	≤25ns	≤25ns	≤25ns	≤25ns
Operating temperature range	Tu	-40°C-80°C	-40°C-80°C	-40°C-80°C	-40°C-80°C	-40°C-80°C
Operating state/fault indication		green/red	green/red	green/red	green/red	green/red
Cross-section area (Min.)		4 mm <sup>2</sup>	4 mm <sup>2</sup>	4 mm <sup>2</sup>	4 mm <sup>2</sup>	4 mm <sup>2</sup>
Cross-section area (Max.)		35mm <sup>2</sup>	35mm <sup>2</sup>	35mm <sup>2</sup>	35mm <sup>2</sup>	35mm <sup>2</sup>
For mounting on		35mm Din rail				
Enclosure material		Thermoplastic UL94-V0				
Degree of protection		IP20	IP20	IP20	IP20	IP20
Order Code		B18301	B18303	B18305	B18307	B18309
Order Code (With remote signaling)		B18302	B18304	B18306	B18308	B18310

## BR-40 2P

### Type 2 Surge Arrester

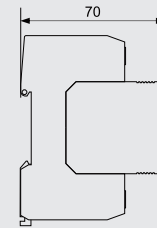
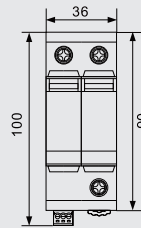
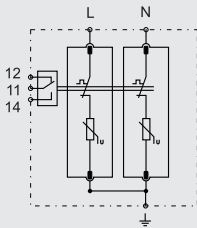
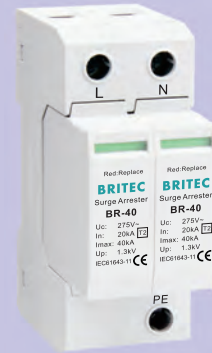

■ BR-40 2 pole surge arrester is suitable for single phase TN system.

	BR-40 150 2P	BR-40 275 2P	BR-40 320 2P	BR-40 385 2P	BR-40 440 2P	
SPD classification according to EN61643-11	Type 2	Type 2	Type 2	Type 2	Type 2	
SPD classification according to IEC61643-11	Class II	Class II	Class II	Class II	Class II	
Max. continuous operating a.c. voltage	Uc	150V	275V	320V	385V	440V
Nominal discharge current (8/20μs)	In	20kA	20kA	20kA	20kA	20kA
Max. discharge current (8/20μs)	Imax	40kA	40kA	40kA	40kA	40kA
Voltage protection level	Up	≤0.8kV	≤1.3kV	≤1.5kV	≤1.8kV	≤2.0kV
Voltage protection level 5kA	Up	≤0.6kV	≤1kV	≤1.2kV	≤1.3kV	≤1.5kV
Max. backup fuse		100A gG	100A gG	100A gG	100A gG	100A gG
Short-circuit withstand capacity	ISCCR	25kA	25kA	25kA	25kA	25kA
Temporary overvoltage TOV-withstand	UT	180V/5sec.	335V/5sec.	400V/5sec.	500V/5sec.	580V/5sec.
Temporary overvoltage TOV-safe failure	UT	230V/120min.	440V/120min.	520V/120min.	650V/120min.	765V/120min.
Leakage current	IPE	<1mA	<1mA	<1mA	<1mA	<1mA
Response time	tA	≤25ns	≤25ns	≤25ns	≤25ns	≤25ns
Operating temperature range	Tu	-40°C-80°C	-40°C-80°C	-40°C-80°C	-40°C-80°C	-40°C-80°C
Operating state/fault indication		green/red	green/red	green/red	green/red	green/red
Cross-section area (Min.)		4 mm <sup>2</sup>	4 mm <sup>2</sup>	4 mm <sup>2</sup>	4 mm <sup>2</sup>	4 mm <sup>2</sup>
Cross-section area (Max.)		35mm <sup>2</sup>	35mm <sup>2</sup>	35mm <sup>2</sup>	35mm <sup>2</sup>	35mm <sup>2</sup>
For mounting on	35mm Din rail					
Enclosure material	Thermoplastic UL94-V0					
Degree of protection	IP20	IP20	IP20	IP20	IP20	
Order Code	B18201	B18203	B18205	B18207	B18209	
Order Code (With remote signaling)	B18202	B18204	B18206	B18208	B18210	

## BR-40 1P

Type 2 Surge Arrester

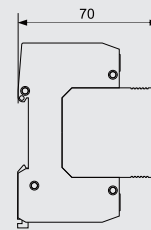
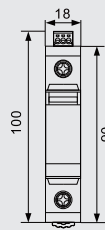
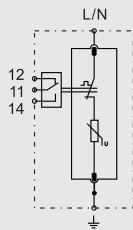

BR-40 1P can be used to build 2P, 3P and 4P surge arresters.

	BR-40 150 1P	BR-40 275 1P	BR-40 320 1P	BR-40 385 1P	BR-40 440 1P	
SPD classification according to EN61643-11	Type 2	Type 2	Type 2	Type 2	Type 2	
SPD classification according to IEC61643-11	Class II	Class II	Class II	Class II	Class II	
Max. continuous operating a.c. voltage	Uc	150V	275V	320V	385V	440V
Nominal discharge current (8/20μs)	In	20kA	20kA	20kA	20kA	20kA
Max. discharge current (8/20μs)	Imax	40kA	40kA	40kA	40kA	40kA
Voltage protection level	Up	≤0.8kV	≤1.3kV	≤1.5kV	≤1.8kV	≤2.0kV
Voltage protection level 5kA	Up	≤0.6kV	≤1kV	≤1.2kV	≤1.3kV	≤1.5kV
Max. backup fuse		100A gG	100A gG	100A gG	100A gG	100A gG
Short-circuit withstand capacity	IscCR	25kA	25kA	25kA	25kA	25kA
Temporary overvoltage TOV-withstand	UT	180V/5sec.	335V/5sec.	400V/5sec.	500V/5sec.	580V/5sec.
Temporary overvoltage TOV-safe failure	UT	230V/120min.	440V/120min.	520V/120min.	650V/120min.	765V/120min.
Leakage current	IPE	<1mA	<1mA	<1mA	<1mA	<1mA
Response time	tA	≤25ns	≤25ns	≤25ns	≤25ns	≤25ns
Operating temperature range	Tu	-40°C-80°C	-40°C-80°C	-40°C-80°C	-40°C-80°C	-40°C-80°C
Operating state/fault indication		green/red	green/red	green/red	green/red	green/red
Cross-section area (Min.)		4 mm <sup>2</sup>	4 mm <sup>2</sup>	4 mm <sup>2</sup>	4 mm <sup>2</sup>	4 mm <sup>2</sup>
Cross-section area (Max.)		35mm <sup>2</sup>	35mm <sup>2</sup>	35mm <sup>2</sup>	35mm <sup>2</sup>	35mm <sup>2</sup>
For mounting on	35mm Din rail					
Enclosure material	Thermoplastic UL94-V0					
Degree of protection	IP20	IP20	IP20	IP20	IP20	
Order Code	B18101	B18103	B18105	B18107	B18109	
Order Code (With remote signaling)	B18102	B18104	B18106	B18108	B18110	

## BR-40 3+1

### Type 2 Surge Arrester

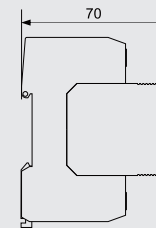
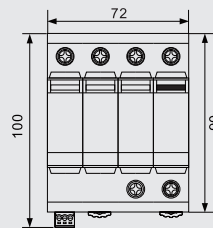
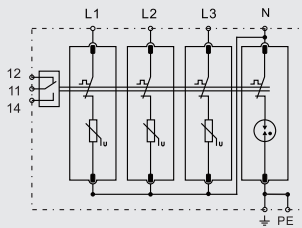

BR-40 3+1 surge arrester is suitable for TT and TN-S system.

	BR-40 150 3+1	BR-40 275 3+1	BR-40 320 3+1	BR-40 385 3+1	BR-40 440 3+1
SPD classification according to EN61643-11	Type 2	Type 2	Type 2	Type 2	Type 2
SPD classification according to IEC61643-11	Class II	Class II	Class II	Class II	Class II
Max. continuous operating a.c. voltage [L-N] $U_c$	150V	275V	320V	385V	440V
Max. continuous operating a.c. voltage [N-PE] $U_c$	255V	255V	255V	255V	255V
Nominal discharge current (8/20 $\mu$ s) $I_n$	20kA	20kA	20kA	20kA	20kA
Max. discharge current (8/20 $\mu$ s) $I_{max}$	40kA	40kA	40kA	40kA	40kA
Voltage protection level [L-N] $U_p$	$\leq 0.8kV$	$\leq 1.3kV$	$\leq 1.5kV$	$\leq 1.8kV$	$\leq 2.0kV$
Voltage protection level 5kA [L-N] $U_p$	$\leq 0.6kV$	$\leq 1kV$	$\leq 1.2kV$	$\leq 1.3kV$	$\leq 1.5kV$
Voltage protection level [N-PE] $U_p$	$\leq 1.5kV$	$\leq 1.5kV$	$\leq 1.5kV$	$\leq 1.5kV$	$\leq 1.5kV$
Short-circuit withstand capacity $I_{SCCR}$	25kA	25kA	25kA	25kA	25kA
Temporary overvoltage TOV-withstand [L-N] $U_T$	180V/5sec.	335V/5sec.	400V/5sec.	500V/5sec.	580V/5sec.
Temporary overvoltage TOV-safe failure [L-N] $U_T$	230V/120min.	440V/120min.	520V/120min.	650V/120min.	765V/120min.
Temporary overvoltage TOV-withstand [N-PE] $U_T$	1200V/200ms	1200V/200ms	1200V/200ms	1200V/200ms	1200V/200ms
Follow current extinguishing capability a.c. [N-PE] $I_{fi}$	100Arms	100Arms	100Arms	100Arms	100Arms
Max. backup fuse	100A gG	100A gG	100A gG	100A gG	100A gG
Leakage current $I_{PE}$	None	None	None	None	None
Response time [L-N] $t_A$	$\leq 25ns$	$\leq 25ns$	$\leq 25ns$	$\leq 25ns$	$\leq 25ns$
Response time [N-PE] $t_A$	$\leq 100ns$	$\leq 100ns$	$\leq 100ns$	$\leq 100ns$	$\leq 100ns$
Operating temperature range $T_u$	-40°C-80°C	-40°C-80°C	-40°C-80°C	-40°C-80°C	-40°C-80°C
Operating state/fault indication	green/red	green/red	green/red	green/red	green/red
Cross-section area (Min.)	4 mm <sup>2</sup>	4 mm <sup>2</sup>	4 mm <sup>2</sup>	4 mm <sup>2</sup>	4 mm <sup>2</sup>
Cross-section area (Max.)	35mm <sup>2</sup>	35mm <sup>2</sup>	35mm <sup>2</sup>	35mm <sup>2</sup>	35mm <sup>2</sup>
For mounting on	35mm Din rail				
Enclosure material	Thermoplastic UL94-V0				
Degree of protection	IP20	IP20	IP20	IP20	IP20
Order Code	B18451	B18453	B18455	B18457	B18249
Order Code (With remote signaling)	B18452	B18454	B18456	B18458	B18250

## BR-40 1+1

### Type 2 Surge Arrester

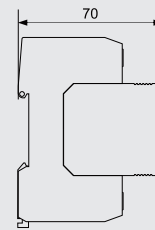
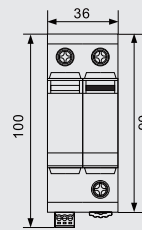
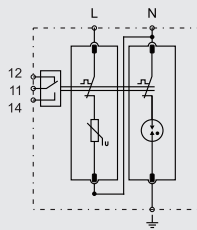

BR-40 1+1 surge arrester is suitable for single phase TT and TN system.

	BR-40 150 1+1	BR-40 275 1+1	BR-40 320 1+1	BR-40 385 1+1	BR-40 440 1+1
SPD classification according to EN61643-11	Type 2	Type 2	Type 2	Type 2	Type 2
SPD classification according to IEC61643-11	Class II	Class II	Class II	Class II	Class II
Max. continuous operating a.c. voltage [L-N] U <sub>c</sub>	150V	275V	320V	385V	440V
Max. continuous operating a.c. voltage [N-PE] U <sub>c</sub>	255V	255V	255V	255V	255V
Nominal discharge current (8/20μs) I <sub>n</sub>	20kA	20kA	20kA	20kA	20kA
Max. discharge current (8/20μs) I <sub>max</sub>	40kA	40kA	40kA	40kA	40kA
Voltage protection level [L-N] U <sub>p</sub>	≤0.8kV	≤1.3kV	≤1.5kV	≤1.8kV	≤2.0kV
Voltage protection level 5kA [L-N] U <sub>p</sub>	≤0.6kV	≤1kV	≤1.2kV	≤1.3kV	≤1.5kV
Voltage protection level [N-PE] U <sub>p</sub>	≤1.5kV	≤1.5kV	≤1.5kV	≤1.5kV	≤1.5kV
Short-circuit withstand capacity I <sub>SCCR</sub>	25kA	25kA	25kA	25kA	25kA
Temporary overvoltage TOV-withstand [L-N] U <sub>T</sub>	180V/5sec.	335V/5sec.	400V/5sec.	500V/5sec.	580V/5sec.
Temporary overvoltage TOV-safe failure [L-N] U <sub>T</sub>	230V/120min.	440V/120min.	520V/120min.	650V/120min.	765V/120min.
Temporary overvoltage TOV-withstand [N-PE] U <sub>T</sub>	1200V/200ms	1200V/200ms	1200V/200ms	1200V/200ms	1200V/200ms
Follow current extinguishing capability a.c. [N-PE] I <sub>fi</sub>	100Arms	100Arms	100Arms	100Arms	100Arms
Max. backup fuse	100A gG	100A gG	100A gG	100A gG	100A gG
Leakage current I <sub>PE</sub>	None	None	None	None	None
Response time [L-N] t <sub>A</sub>	≤25ns	≤25ns	≤25ns	≤25ns	≤25ns
Response time [N-PE] t <sub>A</sub>	≤100ns	≤100ns	≤100ns	≤100ns	≤100ns
Operating temperature range T <sub>u</sub>	-40°C-80°C	-40°C-80°C	-40°C-80°C	-40°C-80°C	-40°C-80°C
Operating state/fault indication	green/red	green/red	green/red	green/red	green/red
Cross-section area (Min.)	4 mm <sup>2</sup>	4 mm <sup>2</sup>	4 mm <sup>2</sup>	4 mm <sup>2</sup>	4 mm <sup>2</sup>
Cross-section area (Max.)	35mm <sup>2</sup>	35mm <sup>2</sup>	35mm <sup>2</sup>	35mm <sup>2</sup>	35mm <sup>2</sup>
For mounting on	35mm Din rail				
Enclosure material	Thermoplastic UL94-V0				
Degree of protection	IP20	IP20	IP20	IP20	IP20
Order Code	B18251	B18253	B18255	B18257	B18370
Order Code (With remote signaling)	B18252	B18254	B18256	B18258	B18371

## BR-20 4P

### Type 2 Surge Arrester

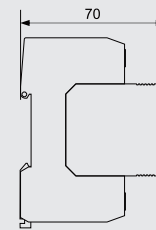
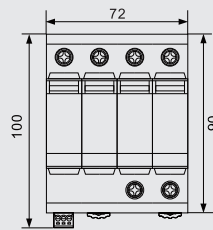
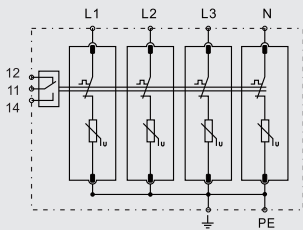
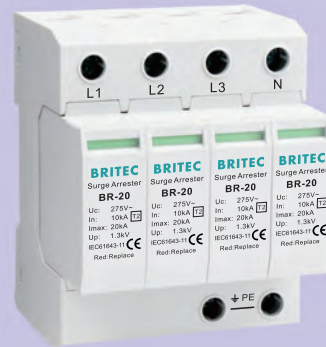

BR-20 4 pole surge arrester is suitable for TN-S system.

	BR-20 150 4P	BR-20 275 4P	BR-20 320 4P	BR-20 385 4P	BR-20 440 4P	
SPD classification according to EN61643-11	Type 2	Type 2	Type 2	Type 2	Type 2	
SPD classification according to IEC61643-11	Class II	Class II	Class II	Class II	Class II	
Max. continuous operating a.c. voltage	$U_c$	150V	275V	320V	385V	440V
Nominal discharge current (8/20 $\mu$ s)	$I_n$	10kA	10kA	10kA	10kA	10kA
Max. discharge current (8/20 $\mu$ s)	$I_{max}$	20kA	20kA	20kA	20kA	20kA
Voltage protection level	$U_p$	$\leq 0.8kV$	$\leq 1.3kV$	$\leq 1.5kV$	$\leq 1.8kV$	$\leq 2.0kV$
Voltage protection level 5kA	$U_p$	$\leq 0.6kV$	$\leq 1kV$	$\leq 1.2kV$	$\leq 1.3kV$	$\leq 1.5kV$
Max. backup fuse		63A gG	63A gG	63A gG	63A gG	63A gG
Short-circuit withstand capacity	$I_{SCCR}$	25kA	25kA	25kA	25kA	25kA
Temporary overvoltage TOV-withstand	$U_T$	180V/5sec.	335V/5sec.	400V/5sec.	500V/5sec.	580V/5sec.
Temporary overvoltage TOV-safe failure	$U_T$	230V/120min.	440V/120min.	520V/120min.	650V/120min.	765V/120min.
Leakage current	$I_{PE}$	$< 0.5mA$	$< 0.5mA$	$< 0.5mA$	$< 0.5mA$	$< 0.5mA$
Response time	$t_A$	$\leq 25ns$	$\leq 25ns$	$\leq 25ns$	$\leq 25ns$	$\leq 25ns$
Operating temperature range	$T_u$	$-40^{\circ}C - 80^{\circ}C$	$-40^{\circ}C - 80^{\circ}C$	$-40^{\circ}C - 80^{\circ}C$	$-40^{\circ}C - 80^{\circ}C$	$-40^{\circ}C - 80^{\circ}C$
Operating state/fault indication		green/red	green/red	green/red	green/red	green/red
Cross-section area (Min.)		4 mm <sup>2</sup>	4 mm <sup>2</sup>	4 mm <sup>2</sup>	4 mm <sup>2</sup>	4 mm <sup>2</sup>
Cross-section area (Max.)		35mm <sup>2</sup>	35mm <sup>2</sup>	35mm <sup>2</sup>	35mm <sup>2</sup>	35mm <sup>2</sup>
For mounting on	35mm Din rail					
Enclosure material	Thermoplastic UL94-V0					
Degree of protection	IP20	IP20	IP20	IP20	IP20	
Order Code	B18701	B18703	B18705	B18707	B18709	
Order Code (With remote signaling)	B18702	B18704	B18706	B18708	B18710	

## BR-20 3P

### Type 2 Surge Arrester

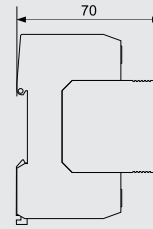
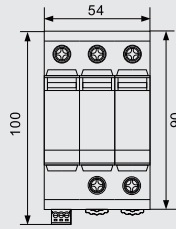
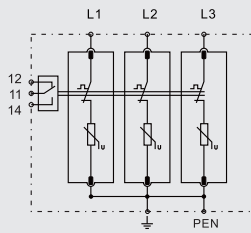
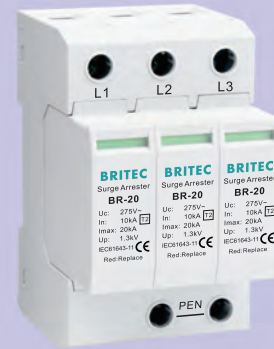

BR-20 3 pole surge arrester is suitable for TN-C system.

	BR-20 150 3P	BR-20 275 3P	BR-20 320 3P	BR-20 385 3P	BR-20 440 3P	
SPD classification according to EN61643-11	Type 2	Type 2	Type 2	Type 2	Type 2	
SPD classification according to IEC61643-11	Class II	Class II	Class II	Class II	Class II	
Max. continuous operating a.c. voltage	Uc	150V	275V	320V	385V	440V
Nominal discharge current (8/20µs)	In	10kA	10kA	10kA	10kA	10kA
Max. discharge current (8/20µs)	Imax	20kA	20kA	20kA	20kA	20kA
Voltage protection level	Up	≤0.8kV	≤1.3kV	≤1.5kV	≤1.8kV	≤2.0kV
Voltage protection level 5kA	Up	≤0.6kV	≤1kV	≤1.2kV	≤1.3kV	≤1.5kV
Max. backup fuse		63A gG	63A gG	63A gG	63A gG	63A gG
Short-circuit withstand capacity	IscCR	25kA	25kA	25kA	25kA	25kA
Temporary overvoltage TOV-withstand	UT	180V/5sec.	335V/5sec.	400V/5sec.	500V/5sec.	580V/5sec.
Temporary overvoltage TOV-safe failure	UT	230V/120min.	440V/120min.	520V/120min.	650V/120min.	765V/120min.
Leakage current	IPE	<0.5mA	<0.5mA	<0.5mA	<0.5mA	<0.5mA
Response time	tA	≤25ns	≤25ns	≤25ns	≤25ns	≤25ns
Operating temperature range	Tu	-40°C-80°C	-40°C-80°C	-40°C-80°C	-40°C-80°C	-40°C-80°C
Operating state/fault indication		green/red	green/red	green/red	green/red	green/red
Cross-section area (Min.)		4 mm <sup>2</sup>	4 mm <sup>2</sup>	4 mm <sup>2</sup>	4 mm <sup>2</sup>	4 mm <sup>2</sup>
Cross-section area (Max.)		35mm <sup>2</sup>	35mm <sup>2</sup>	35mm <sup>2</sup>	35mm <sup>2</sup>	35mm <sup>2</sup>
For mounting on		35mm Din rail				
Enclosure material		Thermoplastic UL94-V0				
Degree of protection		IP20	IP20	IP20	IP20	IP20
Order Code		B18711	B18713	B18715	B18717	B18719
Order Code (With remote signaling)		B18712	B18714	B18716	B18718	B18720

## BR-20 2P

### Type 2 Surge Arrester

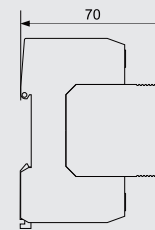
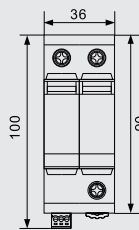
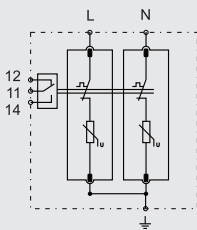
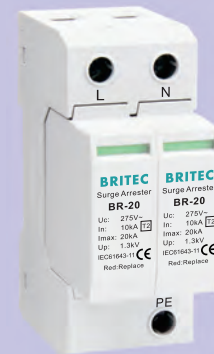

■ BR-20 2 pole surge arrester is suitable for single phase TN system.

	BR-20 150 2P	BR-20 275 2P	BR-20 320 2P	BR-20 385 2P	BR-20 440 2P	
SPD classification according to EN61643-11	Type 2	Type 2	Type 2	Type 2	Type 2	
SPD classification according to IEC61643-11	Class II	Class II	Class II	Class II	Class II	
Max. continuous operating a.c. voltage	Uc	150V	275V	320V	385V	440V
Nominal discharge current (8/20μs)	In	10kA	10kA	10kA	10kA	10kA
Max. discharge current (8/20μs)	I <sub>max</sub>	20kA	20kA	20kA	20kA	20kA
Voltage protection level	Up	≤0.8kV	≤1.3kV	≤1.5kV	≤1.8kV	≤2.0kV
Voltage protection level 5kA	Up	≤0.6kV	≤1kV	≤1.2kV	≤1.3kV	≤1.5kV
Max. backup fuse		63A gG	63A gG	63A gG	63A gG	63A gG
Short-circuit withstand capacity	I <sub>SCCR</sub>	25kA	25kA	25kA	25kA	25kA
Temporary overvoltage TOV-withstand	U <sub>T</sub>	180V/5sec.	335V/5sec.	400V/5sec.	500V/5sec.	580V/5sec.
Temporary overvoltage TOV-safe failure	U <sub>T</sub>	230V/120min.	440V/120min.	520V/120min.	650V/120min.	765V/120min.
Leakage current	I <sub>PE</sub>	<1mA	<1mA	<1mA	<1mA	<1mA
Response time	t <sub>A</sub>	≤25ns	≤25ns	≤25ns	≤25ns	≤25ns
Operating temperature range	T <sub>u</sub>	-40°C-80°C	-40°C-80°C	-40°C-80°C	-40°C-80°C	-40°C-80°C
Operating state/fault indication		green/red	green/red	green/red	green/red	green/red
Cross-section area (Min.)		4 mm <sup>2</sup>	4 mm <sup>2</sup>	4 mm <sup>2</sup>	4 mm <sup>2</sup>	4 mm <sup>2</sup>
Cross-section area (Max.)		35mm <sup>2</sup>	35mm <sup>2</sup>	35mm <sup>2</sup>	35mm <sup>2</sup>	35mm <sup>2</sup>
For mounting on		35mm Din rail				
Enclosure material		Thermoplastic UL94-V0				
Degree of protection		IP20	IP20	IP20	IP20	IP20
Order Code		B18721	B18723	B18725	B18727	B18729
Order Code (With remote signaling)		B18722	B18724	B18726	B18728	B18730

## BR-20 1P

Type 2 Surge Arrester

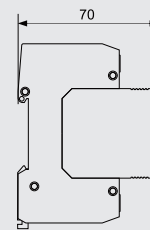
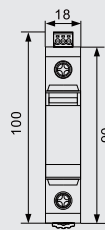
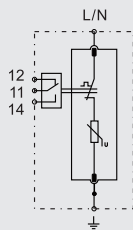

BR-20 1P can be used to build 2P, 3P and 4P surge arresters.

	BR-20 150 1P	BR-20 275 1P	BR-20 320 1P	BR-20 385 1P	BR-20 440 1P	
SPD classification according to EN61643-11	Type 2	Type 2	Type 2	Type 2	Type 2	
SPD classification according to IEC61643-11	Class II	Class II	Class II	Class II	Class II	
Max. continuous operating a.c. voltage	Uc	150V	275V	320V	385V	440V
Nominal discharge current (8/20µs)	In	10kA	10kA	10kA	10kA	10kA
Max. discharge current (8/20µs)	Imax	20kA	20kA	20kA	20kA	20kA
Voltage protection level	Up	≤0.8kV	≤1.3kV	≤1.5kV	≤1.8kV	≤2.0kV
Voltage protection level 5kA	Up	≤0.6kV	≤1kV	≤1.2kV	≤1.3kV	≤1.5kV
Max. backup fuse		63A gG	63A gG	63A gG	63A gG	63A gG
Short-circuit withstand capacity	ISCCR	25kA	25kA	25kA	25kA	25kA
Temporary overvoltage TOV-withstand	UT	180V/5sec.	335V/5sec.	400V/5sec.	500V/5sec.	580V/5sec.
Temporary overvoltage TOV-safe failure	UT	230V/120min.	440V/120min.	520V/120min.	650V/120min.	765V/120min.
Leakage current	IPE	<1mA	<1mA	<1mA	<1mA	<1mA
Response time	tA	≤25ns	≤25ns	≤25ns	≤25ns	≤25ns
Operating temperature range	Tu	-40°C-80°C	-40°C-80°C	-40°C-80°C	-40°C-80°C	-40°C-80°C
Operating state/fault indication		green/red	green/red	green/red	green/red	green/red
Cross-section area (Min.)		4 mm <sup>2</sup>	4 mm <sup>2</sup>	4 mm <sup>2</sup>	4 mm <sup>2</sup>	4 mm <sup>2</sup>
Cross-section area (Max.)		35mm <sup>2</sup>	35mm <sup>2</sup>	35mm <sup>2</sup>	35mm <sup>2</sup>	35mm <sup>2</sup>
For mounting on	35mm Din rail					
Enclosure material	Thermoplastic UL94-V0					
Degree of protection	IP20	IP20	IP20	IP20	IP20	
Order Code	B18731	B18733	B18735	B18737	B18739	
Order Code (With remote signaling)	B18732	B18734	B18736	B18738	B18740	

## BR-20 3+1

### Type 2 Surge Arrester

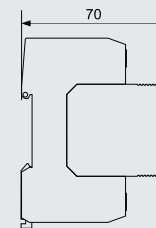
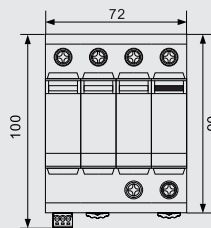
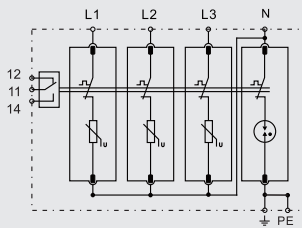
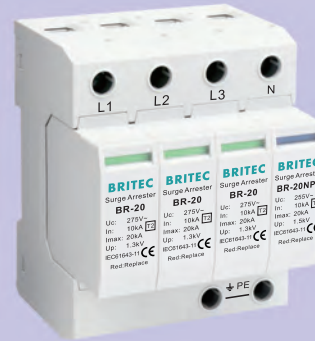

BR-20 3+1 surge arrester is suitable for TT and TN-S system.

	BR-20 150 3+1	BR-20 275 3+1	BR-20 320 3+1	BR-20 385 3+1	BR-20 440 3+1
SPD classification according to EN61643-11	Type 2	Type 2	Type 2	Type 2	Type 2
SPD classification according to IEC61643-11	Class II	Class II	Class II	Class II	Class II
Max. continuous operating a.c. voltage [L-N] $U_c$	150V	275V	320V	385V	440V
Max. continuous operating a.c. voltage [N-PE] $U_c$	255V	255V	255V	255V	255V
Nominal discharge current (8/20 $\mu$ s) $I_n$	10kA	10kA	10kA	10kA	10kA
Max. discharge current (8/20 $\mu$ s) $I_{max}$	20kA	20kA	20kA	20kA	20kA
Voltage protection level [L-N] $U_p$	$\leq 0.8kV$	$\leq 1.3kV$	$\leq 1.5kV$	$\leq 1.8kV$	$\leq 2.0kV$
Voltage protection level 5kA [L-N] $U_p$	$\leq 0.6kV$	$\leq 1kV$	$\leq 1.2kV$	$\leq 1.3kV$	$\leq 1.5kV$
Voltage protection level [N-PE] $U_p$	$\leq 1.5kV$	$\leq 1.5kV$	$\leq 1.5kV$	$\leq 1.5kV$	$\leq 1.5kV$
Short-circuit withstand capacity $I_{SCCR}$	25kA	25kA	25kA	25kA	25kA
Temporary overvoltage TOV-withstand [L-N] $U_T$	180V/5sec.	335V/5sec.	400V/5sec.	500V/5sec.	580V/5sec.
Temporary overvoltage TOV-safe failure [L-N] $U_T$	230V/120min.	440V/120min.	520V/120min.	650V/120min.	765V/120min.
Temporary overvoltage TOV-withstand [N-PE] $U_T$	1200V/200ms	1200V/200ms	1200V/200ms	1200V/200ms	1200V/200ms
Follow current extinguishing capability a.c. [N-PE] $I_{fi}$	100Arms	100Arms	100Arms	100Arms	100Arms
Max. backup fuse	63A gG	63A gG	63A gG	63A gG	63A gG
Leakage current $I_{PE}$	None	None	None	None	None
Response time [L-N] $t_A$	$\leq 25ns$	$\leq 25ns$	$\leq 25ns$	$\leq 25ns$	$\leq 25ns$
Response time [N-PE] $t_A$	$\leq 100ns$	$\leq 100ns$	$\leq 100ns$	$\leq 100ns$	$\leq 100ns$
Operating temperature range $T_u$	-40°C-80°C	-40°C-80°C	-40°C-80°C	-40°C-80°C	-40°C-80°C
Operating state/fault indication	green/red	green/red	green/red	green/red	green/red
Cross-section area (Min.)	4 mm <sup>2</sup>	4 mm <sup>2</sup>	4 mm <sup>2</sup>	4 mm <sup>2</sup>	4 mm <sup>2</sup>
Cross-section area (Max.)	35mm <sup>2</sup>	35mm <sup>2</sup>	35mm <sup>2</sup>	35mm <sup>2</sup>	35mm <sup>2</sup>
For mounting on	35mm Din rail				
Enclosure material	Thermoplastic UL94-V0				
Degree of protection	IP20	IP20	IP20	IP20	IP20
Order Code	B18741	B18743	B18745	B18747	B18749
Order Code (With remote signaling)	B18742	B18744	B18746	B18748	B18750

## BR-20 1+1

Type 2 Surge Arrester

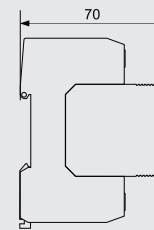
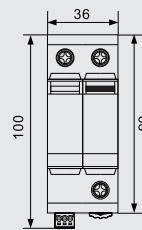
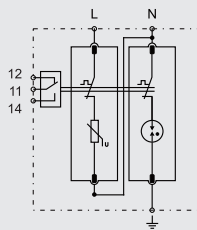

BR-20 1+1 surge arrester is suitable for single phase TT and TN system.

	BR-20 150 1+1	BR-20 275 1+1	BR-20 320 1+1	BR-20 385 1+1	BR-20 440 1+1
SPD classification according to EN61643-11	Type 2	Type 2	Type 2	Type 2	Type 2
SPD classification according to IEC61643-11	Class II	Class II	Class II	Class II	Class II
Max. continuous operating a.c. voltage [L-N] Uc	150V	275V	320V	385V	440V
Max. continuous operating a.c. voltage [N-PE] Uc	255V	255V	255V	255V	255V
Nominal discharge current (8/20µs) In	10kA	10kA	10kA	10kA	10kA
Max. discharge current (8/20µs) Imax	20kA	20kA	20kA	20kA	20kA
Voltage protection level [L-N] Up	≤0.8kV	≤1.3kV	≤1.5kV	≤1.8kV	≤2.0kV
Voltage protection level 5kA [L-N] Up	≤0.6kV	≤1kV	≤1.2kV	≤1.3kV	≤1.5kV
Voltage protection level [N-PE] Up	≤1.5kV	≤1.5kV	≤1.5kV	≤1.5kV	≤1.5kV
Short-circuit withstand capacity I <sub>CCR</sub>	25kA	25kA	25kA	25kA	25kA
Temporary overvoltage TOV-withstand [L-N] U <sub>T</sub>	180V/5sec.	335V/5sec.	400V/5sec.	500V/5sec.	580V/5sec.
Temporary overvoltage TOV-safe failure [L-N] U <sub>T</sub>	230V/120min.	440V/120min.	520V/120min.	650V/120min.	765V/120min.
Temporary overvoltage TOV-withstand [N-PE] U <sub>T</sub>	1200V/200ms	1200V/200ms	1200V/200ms	1200V/200ms	1200V/200ms
Follow current extinguishing capability a.c. [N-PE] I <sub>fi</sub>	100Arms	100Arms	100Arms	100Arms	100Arms
Max. backup fuse	63A gG	63A gG	63A gG	63A gG	63A gG
Leakage current I <sub>PE</sub>	None	None	None	None	None
Response time [L-N] t <sub>A</sub>	≤25ns	≤25ns	≤25ns	≤25ns	≤25ns
Response time [N-PE] t <sub>A</sub>	≤100ns	≤100ns	≤100ns	≤100ns	≤100ns
Operating temperature range T <sub>u</sub>	-40°C-80°C	-40°C-80°C	-40°C-80°C	-40°C-80°C	-40°C-80°C
Operating state/fault indication	green/red	green/red	green/red	green/red	green/red
Cross-section area (Min.)	4 mm <sup>2</sup>	4 mm <sup>2</sup>	4 mm <sup>2</sup>	4 mm <sup>2</sup>	4 mm <sup>2</sup>
Cross-section area (Max.)	35mm <sup>2</sup>	35mm <sup>2</sup>	35mm <sup>2</sup>	35mm <sup>2</sup>	35mm <sup>2</sup>
For mounting on	35mm Din rail				
Enclosure material	Thermoplastic UL94-V0				
Degree of protection	IP20	IP20	IP20	IP20	IP20
Order Code	B18751	B18753	B18755	B18757	B18759
Order Code (With remote signaling)	B18752	B18754	B18756	B18758	B18760

## BR-40 4P 690/800/1000 Type 2 Surge Arrester

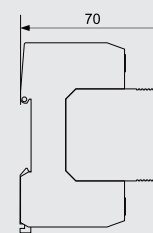
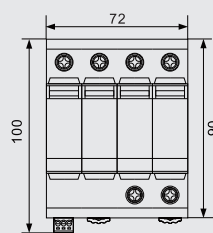
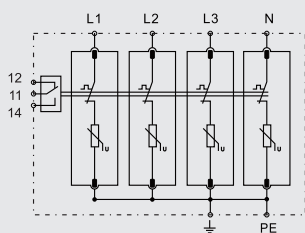

BR-40 4 pole surge arrester is suitable for TN-S system.

	BR-40 690 4P	BR-40 800 4P	BR-40 1000 4P
SPD classification according to EN61643-11	Type 2	Type 2	Type 2
SPD classification according to IEC61643-11	Class II	Class II	Class II
Max. continuous operating a.c. voltage $U_c$	690V	800V	1000V
Nominal discharge current (8/20 $\mu$ s) $I_n$	20kA	20kA	20kA
Max. discharge current (8/20 $\mu$ s) $I_{max}$	40kA	40kA	40kA
Voltage protection level $U_p$	$\leq 3.2kV$	$\leq 3.6kV$	$\leq 4.0kV$
Voltage protection level 5kA $U_p$	$\leq 2.3kV$	$\leq 2.8kV$	$\leq 3.3kV$
Max. backup fuse	100A gG	100A gG	100A gG
Short-circuit withstand capacity $I_{SCCR}$	25kA	25kA	25kA
Temporary overvoltage TOV-withstand $U_T$	800V/5sec.	1000V/5sec.	1100V/5sec.
Temporary overvoltage TOV-safe failure $U_T$	1000V/120min.	1200V/120min.	1400V/120min.
Leakage current $I_{PE}$	<0.5mA	<0.5mA	<0.5mA
Response time $t_A$	$\leq 25ns$	$\leq 25ns$	$\leq 25ns$
Operating temperature range $T_u$	-40°C-80°C	-40°C-80°C	-40°C-80°C
Operating state/fault indication	green/red	green/red	green/red
Cross-section area (Min.)	4 mm <sup>2</sup>	4 mm <sup>2</sup>	4 mm <sup>2</sup>
Cross-section area (Max.)	35mm <sup>2</sup>	35mm <sup>2</sup>	35mm <sup>2</sup>
For mounting on	35mm Din rail		
Enclosure material	Thermoplastic UL94-V0		
Degree of protection	IP20	IP20	IP20
Order Code	B18036	B7957	B18052
Order Code (With remote signaling)	B18037	B7958	B18053

## BR-40 3P 690/800/1000 Type 2 Surge Arrester

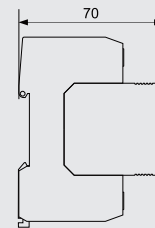
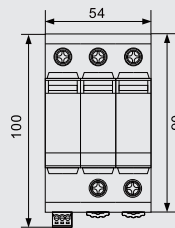
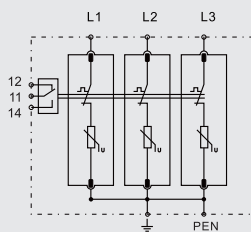
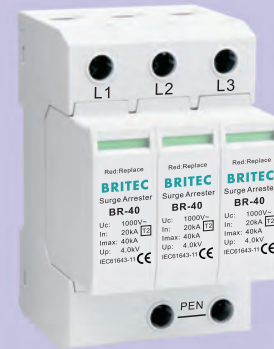

■ BR-40 3 pole surge arrester is suitable for TN-C system.

		BR-40 690 3P	BR-40 800 3P	BR-40 1000 3P
SPD classification according to EN61643-11		Type 2	Type 2	Type 2
SPD classification according to IEC61643-11		Class II	Class II	Class II
Max. continuous operating a.c. voltage	U <sub>c</sub>	690V	800V	1000V
Nominal discharge current (8/20μs)	I <sub>n</sub>	20kA	20kA	20kA
Max. discharge current (8/20μs)	I <sub>max</sub>	40kA	40kA	40kA
Voltage protection level	U <sub>p</sub>	≤3.2kV	≤3.6kV	≤4.0kV
Voltage protection level 5kA	U <sub>p</sub>	≤2.3kV	≤2.8kV	≤3.3kV
Max. backup fuse		100A gG	100A gG	100A gG
Short-circuit withstand capacity	I <sub>SCCR</sub>	25kA	25kA	25kA
Temporary overvoltage TOV-withstand	U <sub>T</sub>	800V/5sec.	1000V/5sec.	1100V/5sec.
Temporary overvoltage TOV-safe failure	U <sub>T</sub>	1000V/120min.	1200V/120min.	1400V/120min.
Leakage current	I <sub>PE</sub>	<0.5mA	<0.5mA	<0.5mA
Response time	t <sub>A</sub>	≤25ns	≤25ns	≤25ns
Operating temperature range	T <sub>u</sub>	-40°C-80°C	-40°C-80°C	-40°C-80°C
Operating state/fault indication		green/red	green/red	green/red
Cross-section area (Min.)		4 mm <sup>2</sup>	4 mm <sup>2</sup>	4 mm <sup>2</sup>
Cross-section area (Max.)		35mm <sup>2</sup>	35mm <sup>2</sup>	35mm <sup>2</sup>
For mounting on		35mm Din rail		
Enclosure material		Thermoplastic UL94-V0		
Degree of protection		IP20	IP20	IP20
Order Code		B18034	B7955	B18050
Order Code (With remote signaling)		B18035	B7956	B18051

## BR-40VG 4P

### Type 2 Surge Arrester

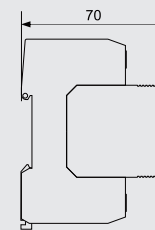
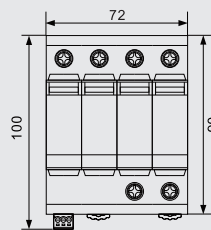
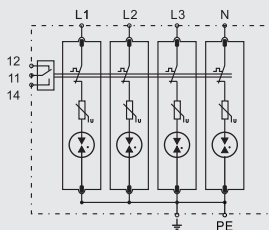

■ BR-40VG 4 pole surge arrester is suitable for TN-S system.

	BR-40VG 150 4P	BR-40VG 275 4P	BR-40VG 320 4P	BR-40VG 385 4P	BR-40VG 440 4P
SPD classification according to EN61643-11	Type 2	Type 2	Type 2	Type 2	Type 2
SPD classification according to IEC61643-11	Class II	Class II	Class II	Class II	Class II
Max. continuous operating a.c. voltage $U_c$	150V	275V	320V	385V	440V
Nominal discharge current (8/20 $\mu$ s) $I_n$	20kA	20kA	20kA	20kA	20kA
Max. discharge current (8/20 $\mu$ s) $I_{max}$	40kA	40kA	40kA	40kA	40kA
Voltage protection level $U_p$	$\leq 1.3kV$	$\leq 1.3kV$	$\leq 1.5kV$	$\leq 1.8kV$	$\leq 2.0kV$
Max. backup fuse	100A gG	100A gG	100A gG	100A gG	100A gG
Short-circuit withstand capacity $I_{SCCR}$	25kA	25kA	25kA	25kA	25kA
Temporary overvoltage TOV-withstand $U_T$	180V/5sec.	335V/5sec.	400V/5sec.	500V/5sec.	580V/5sec.
Temporary overvoltage TOV-safe failure $U_T$	230V/120min.	440V/120min.	520V/120min.	650V/120min.	765V/120min.
Leakage current $I_{PE}$	None	None	None	None	None
Response time $t_A$	$\leq 100ns$	$\leq 100ns$	$\leq 100ns$	$\leq 100ns$	$\leq 100ns$
Operating temperature range $T_u$	-40°C-80°C	-40°C-80°C	-40°C-80°C	-40°C-80°C	-40°C-80°C
Operating state/fault indication	green/red	green/red	green/red	green/red	green/red
Cross-section area (Min.)	4 mm <sup>2</sup>	4 mm <sup>2</sup>	4 mm <sup>2</sup>	4 mm <sup>2</sup>	4 mm <sup>2</sup>
Cross-section area (Max.)	35mm <sup>2</sup>	35mm <sup>2</sup>	35mm <sup>2</sup>	35mm <sup>2</sup>	35mm <sup>2</sup>
For mounting on	35mm Din rail				
Enclosure material	Thermoplastic UL94-V0				
Degree of protection	IP20	IP20	IP20	IP20	IP20
Order Code	B17506	B17518	B17530	B17542	B17554
Order Code (With remote signaling)	B17507	B17519	B17531	B17543	B17555

## BR-40VG 3P

Type 2 Surge Arrester

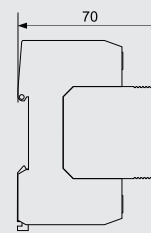
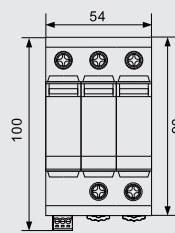
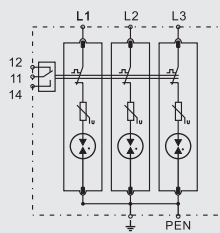
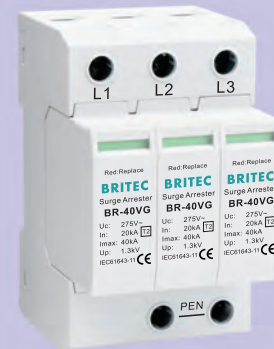

■ BR-40VG 3 pole surge arrester is suitable for TN-C system.

	BR-40VG 150 3P	BR-40VG 275 3P	BR-40VG 320 3P	BR-40VG 385 3P	BR-40VG 440 3P	
SPD classification according to EN61643-11	Type 2	Type 2	Type 2	Type 2	Type 2	
SPD classification according to IEC61643-11	Class II	Class II	Class II	Class II	Class II	
Max. continuous operating a.c. voltage	Uc	150V	275V	320V	440V	
Nominal discharge current (8/20μs)	In	20kA	20kA	20kA	20kA	
Max. discharge current (8/20μs)	I <sub>max</sub>	40kA	40kA	40kA	40kA	
Voltage protection level	Up	≤1.3kV	≤1.3kV	≤1.5kV	≤1.8kV	≤2.0kV
Max. backup fuse		100A gG	100A gG	100A gG	100A gG	100A gG
Short-circuit withstand capacity	I <sub>SCCR</sub>	25kA	25kA	25kA	25kA	25kA
Temporary overvoltage TOV-withstand	U <sub>T</sub>	180V/5sec.	335V/5sec.	400V/5sec.	500V/5sec.	580V/5sec.
Temporary overvoltage TOV-safe failure	U <sub>T</sub>	230V/120min.	440V/120min.	520V/120min.	650V/120min.	765V/120min.
Leakage current	I <sub>PE</sub>	None	None	None	None	None
Response time	t <sub>A</sub>	≤100ns	≤100ns	≤100ns	≤100ns	≤100ns
Operating temperature range	T <sub>u</sub>	-40°C-80°C	-40°C-80°C	-40°C-80°C	-40°C-80°C	-40°C-80°C
Operating state/fault indication		green/red	green/red	green/red	green/red	green/red
Cross-section area (Min.)		4 mm <sup>2</sup>	4 mm <sup>2</sup>	4 mm <sup>2</sup>	4 mm <sup>2</sup>	4 mm <sup>2</sup>
Cross-section area (Max.)		35mm <sup>2</sup>	35mm <sup>2</sup>	35mm <sup>2</sup>	35mm <sup>2</sup>	35mm <sup>2</sup>
For mounting on	35mm Din rail					
Enclosure material	Thermoplastic UL94-V0					
Degree of protection	IP20	IP20	IP20	IP20	IP20	
Order Code	B17504	B17516	B17528	B17540	B17552	
Order Code (With remote signaling)	B17505	B17517	B17529	B17541	B17553	

## BR-40VG 2P

### Type 2 Surge Arrester

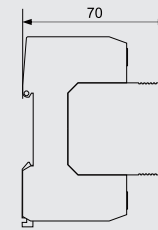
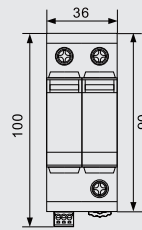
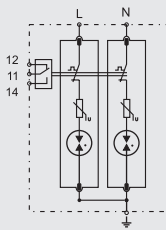

■ BR-40VG 2 pole surge arrester is suitable for single phase TN system.

	BR-40VG 150 2P	BR-40VG 275 2P	BR-40VG 320 2P	BR-40VG 385 2P	BR-40VG 440 2P
SPD classification according to EN61643-11	Type 2	Type 2	Type 2	Type 2	Type 2
SPD classification according to IEC61643-11	Class II	Class II	Class II	Class II	Class II
Max. continuous operating a.c. voltage $U_c$	150V	275V	320V	385V	440V
Nominal discharge current (8/20 $\mu$ s) $I_n$	20kA	20kA	20kA	20kA	20kA
Max. discharge current (8/20 $\mu$ s) $I_{max}$	40kA	40kA	40kA	40kA	40kA
Voltage protection level $U_p$	$\leq 1.3kV$	$\leq 1.3kV$	$\leq 1.5kV$	$\leq 1.8kV$	$\leq 2.0kV$
Max. backup fuse	100A gG	100A gG	100A gG	100A gG	100A gG
Short-circuit withstand capacity $I_{SCCR}$	25kA	25kA	25kA	25kA	25kA
Temporary overvoltage TOV-withstand $U_T$	180V/5sec.	335V/5sec.	400V/5sec.	500V/5sec.	580V/5sec.
Temporary overvoltage TOV-safe failure $U_T$	230V/120min.	440V/120min.	520V/120min.	650V/120min.	765V/120min.
Leakage current $I_{PE}$	None	None	None	None	None
Response time $t_A$	$\leq 100ns$	$\leq 100ns$	$\leq 100ns$	$\leq 100ns$	$\leq 100ns$
Operating temperature range $T_u$	-40°C-80°C	-40°C-80°C	-40°C-80°C	-40°C-80°C	-40°C-80°C
Operating state/fault indication	green/red	green/red	green/red	green/red	green/red
Cross-section area (Min.)	4 mm <sup>2</sup>	4 mm <sup>2</sup>	4 mm <sup>2</sup>	4 mm <sup>2</sup>	4 mm <sup>2</sup>
Cross-section area (Max.)	35mm <sup>2</sup>	35mm <sup>2</sup>	35mm <sup>2</sup>	35mm <sup>2</sup>	35mm <sup>2</sup>
For mounting on	35mm Din rail				
Enclosure material	Thermoplastic UL94-V0				
Degree of protection	IP20	IP20	IP20	IP20	IP20
Order Code	B17502	B17514	B17526	B17538	B17550
Order Code (With remote signaling)	B17503	B17515	B17527	B17539	B17551

## BR-40VG 1P Type 2 Surge Arrester

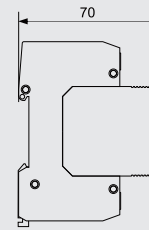
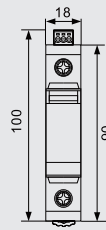
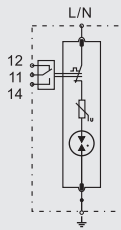

BR-40VG 1P can be used to build 2P, 3P and 4P surge arresters.

	BR-40VG 150 1P	BR-40VG 275 1P	BR-40VG 320 1P	BR-40VG 385 1P	BR-40VG 440 1P	
SPD classification according to EN61643-11	Type 2	Type 2	Type 2	Type 2	Type 2	
SPD classification according to IEC61643-11	Class II	Class II	Class II	Class II	Class II	
Max. continuous operating a.c. voltage	Uc	150V	275V	320V	385V	440V
Nominal discharge current (8/20μs)	In	20kA	20kA	20kA	20kA	20kA
Max. discharge current (8/20μs)	Imax	40kA	40kA	40kA	40kA	40kA
Voltage protection level	Up	≤1.3kV	≤1.3kV	≤1.5kV	≤1.8kV	≤2.0kV
Max. backup fuse		100A gG	100A gG	100A gG	100A gG	100A gG
Short-circuit withstand capacity	IscCR	25kA	25kA	25kA	25kA	25kA
Temporary overvoltage TOV-withstand	UT	180V/5sec.	335V/5sec.	400V/5sec.	500V/5sec.	580V/5sec.
Temporary overvoltage TOV-safe failure	UT	230V/120min.	440V/120min.	520V/120min.	650V/120min.	765V/120min.
Leakage current	IPE	None	None	None	None	None
Response time	tA	≤100ns	≤100ns	≤100ns	≤100ns	≤100ns
Operating temperature range	Tu	-40°C-80°C	-40°C-80°C	-40°C-80°C	-40°C-80°C	-40°C-80°C
Operating state/fault indication		green/red	green/red	green/red	green/red	green/red
Cross-section area (Min.)		4 mm <sup>2</sup>	4 mm <sup>2</sup>	4 mm <sup>2</sup>	4 mm <sup>2</sup>	4 mm <sup>2</sup>
Cross-section area (Max.)		35mm <sup>2</sup>	35mm <sup>2</sup>	35mm <sup>2</sup>	35mm <sup>2</sup>	35mm <sup>2</sup>
For mounting on	35mm Din rail					
Enclosure material	Thermoplastic UL94-V0					
Degree of protection	IP20	IP20	IP20	IP20	IP20	
Order Code	B17500	B17512	B17524	B17536	B17548	
Order Code (With remote signaling)	B17501	B17513	B17525	B17537	B17549	

## BR-40VG 3+1

### Type 2 Surge Arrester

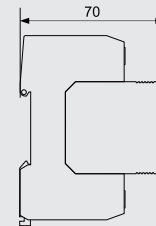
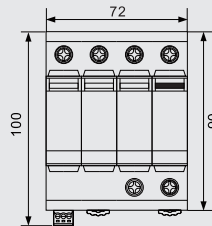
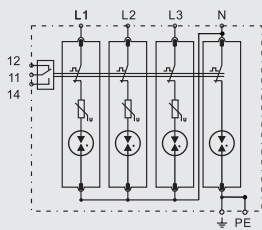

BR-40VG 3+1 surge arrester is suitable for TT and TN-S system.

	BR-40VG 150 3+1	BR-40VG 275 3+1	BR-40VG 320 3+1	BR-40VG 385 3+1	BR-40VG 440 3+1
SPD classification according to EN61643-11	Type 2	Type 2	Type 2	Type 2	Type 2
SPD classification according to IEC61643-11	Class II	Class II	Class II	Class II	Class II
Max. continuous operating a.c. voltage [L-N] U <sub>c</sub>	150V	275V	320V	385V	440V
Max. continuous operating a.c. voltage [N-PE] U <sub>c</sub>	255V	255V	255V	255V	255V
Nominal discharge current (8/20μs) I <sub>n</sub>	20kA	20kA	20kA	20kA	20kA
Max. discharge current (8/20μs) I <sub>max</sub>	40kA	40kA	40kA	40kA	40kA
Voltage protection level [L-N] U <sub>p</sub>	≤1.3kV	≤1.3kV	≤1.5kV	≤1.8kV	≤2.0kV
Voltage protection level [N-PE] U <sub>p</sub>	≤1.5kV	≤1.5kV	≤1.5kV	≤1.5kV	≤1.5kV
Short-circuit withstand capacity I <sub>SCCR</sub>	25kA	25kA	25kA	25kA	25kA
Temporary overvoltage TOV-withstand [L-N] U <sub>T</sub>	180V/5sec.	335V/5sec.	400V/5sec.	500V/5sec.	580V/5sec.
Temporary overvoltage TOV-safe failure [L-N] U <sub>T</sub>	230V/120min.	440V/120min.	520V/120min.	650V/120min.	765V/120min.
Temporary overvoltage TOV-withstand [N-PE] U <sub>T</sub>	1200V/200ms	1200V/200ms	1200V/200ms	1200V/200ms	1200V/200ms
Follow current extinguishing capability a.c. [N-PE] I <sub>fi</sub>	100Arms	100Arms	100Arms	100Arms	100Arms
Max. backup fuse	100A gG	100A gG	100A gG	100A gG	100A gG
Leakage current I <sub>PE</sub>	None	None	None	None	None
Response time [L-N] t <sub>A</sub>	≤100ns	≤100ns	≤100ns	≤100ns	≤100ns
Response time [N-PE] t <sub>A</sub>	≤100ns	≤100ns	≤100ns	≤100ns	≤100ns
Operating temperature range T <sub>u</sub>	-40°C-80°C	-40°C-80°C	-40°C-80°C	-40°C-80°C	-40°C-80°C
Operating state/fault indication	green/red	green/red	green/red	green/red	green/red
Cross-section area (Min.)	4 mm <sup>2</sup>	4 mm <sup>2</sup>	4 mm <sup>2</sup>	4 mm <sup>2</sup>	4 mm <sup>2</sup>
Cross-section area (Max.)	35mm <sup>2</sup>	35mm <sup>2</sup>	35mm <sup>2</sup>	35mm <sup>2</sup>	35mm <sup>2</sup>
For mounting on	35mm Din rail				
Enclosure material	Thermoplastic UL94-V0				
Degree of protection	IP20	IP20	IP20	IP20	IP20
Order Code	B17510	B17522	B17534	B17546	B17558
Order Code (With remote signaling)	B17511	B17523	B17535	B17547	B17559

## BR-40VG 1+1 Type 2 Surge Arrester

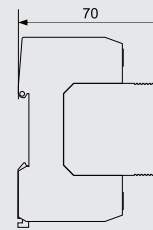
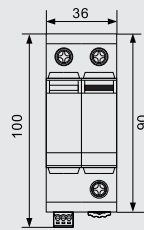
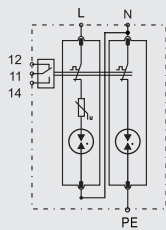

BR-40VG 1+1 surge arrester is suitable for single phase TT and TN system.

	BR-40VG 150 1+1	BR-40VG 275 1+1	BR-40VG 320 1+1	BR-40VG 385 1+1	BR-40VG 440 1+1
SPD classification according to EN61643-11	Type 2	Type 2	Type 2	Type 2	Type 2
SPD classification according to IEC61643-11	Class II	Class II	Class II	Class II	Class II
Max. continuous operating a.c. voltage [L-N] U <sub>c</sub>	150V	275V	320V	385V	440V
Max. continuous operating a.c. voltage [N-PE] U <sub>c</sub>	255V	255V	255V	255V	255V
Nominal discharge current (8/20μs) I <sub>n</sub>	20kA	20kA	20kA	20kA	20kA
Max. discharge current (8/20μs) I <sub>max</sub>	40kA	40kA	40kA	40kA	40kA
Voltage protection level [L-N] U <sub>p</sub>	≤1.3kV	≤1.3kV	≤1.5kV	≤1.8kV	≤2.0kV
Voltage protection level [N-PE] U <sub>p</sub>	≤1.5kV	≤1.5kV	≤1.5kV	≤1.5kV	≤1.5kV
Short-circuit withstand capacity I <sub>scCR</sub>	25kA	25kA	25kA	25kA	25kA
Temporary overvoltage TOV-withstand [L-N] U <sub>T</sub>	180V/5sec.	335V/5sec.	400V/5sec.	500V/5sec.	580V/5sec.
Temporary overvoltage TOV-safe failure [L-N] U <sub>T</sub>	230V/120min.	440V/120min.	520V/120min.	650V/120min.	765V/120min.
Temporary overvoltage TOV-withstand [N-PE] U <sub>T</sub>	1200V/200ms	1200V/200ms	1200V/200ms	1200V/200ms	1200V/200ms
Follow current extinguishing capability a.c. [N-PE] I <sub>fi</sub>	100Arms	100Arms	100Arms	100Arms	100Arms
Max. backup fuse	100A gG	100A gG	100A gG	100A gG	100A gG
Leakage current I <sub>PE</sub>	None	None	None	None	None
Response time [L-N] t <sub>A</sub>	≤100ns	≤100ns	≤100ns	≤100ns	≤100ns
Response time [N-PE] t <sub>A</sub>	≤100ns	≤100ns	≤100ns	≤100ns	≤100ns
Operating temperature range T <sub>u</sub>	-40°C-80°C	-40°C-80°C	-40°C-80°C	-40°C-80°C	-40°C-80°C
Operating state/fault indication	green/red	green/red	green/red	green/red	green/red
Cross-section area (Min.)	4 mm <sup>2</sup>	4 mm <sup>2</sup>	4 mm <sup>2</sup>	4 mm <sup>2</sup>	4 mm <sup>2</sup>
Cross-section area (Max.)	35mm <sup>2</sup>	35mm <sup>2</sup>	35mm <sup>2</sup>	35mm <sup>2</sup>	35mm <sup>2</sup>
For mounting on	35mm Din rail				
Enclosure material	Thermoplastic UL94-V0				
Degree of protection	IP20	IP20	IP20	IP20	IP20
Order Code	B17508	B17520	B17532	B17544	B17556
Order Code (With remote signaling)	B17509	B17521	B17533	B17545	B17557

## BR-30FU 4P

Type 2 Surge Arrester

Backup fuse built inside the SPD

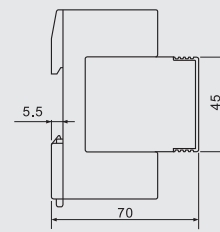
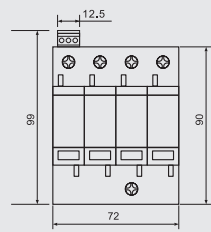
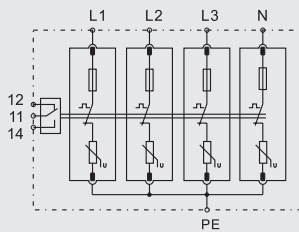
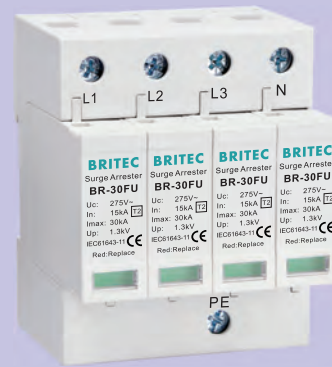

BR-30FU 4 pole surge arrester is suitable for TN-S system. No backup fuse or breakers needed.

	BR-30FU 150 4P	BR-30FU 275 4P	BR-30FU 320 4P	BR-30FU 385 4P	BR-30FU 440 4P	
SPD classification according to EN61643-11	Type 2	Type 2	Type 2	Type 2	Type 2	
SPD classification according to IEC61643-11	Class II	Class II	Class II	Class II	Class II	
Max. continuous operating a.c. voltage	Uc	150V	275V	320V	385V	440V
Nominal discharge current (8/20μs)	In	15kA	15kA	15kA	15kA	15kA
Max. discharge current (8/20μs)	Imax	30kA	30kA	30kA	30kA	30kA
Voltage protection level	Up	≤0.8kV	≤1.3kV	≤1.5kV	≤1.8kV	≤2.0kV
Voltage protection level 5kA	Up	≤0.6kV	≤1kV	≤1.2kV	≤1.3kV	≤1.5kV
Short-circuit withstand capacity	IscCR	25kA	25kA	25kA	25kA	25kA
Temporary overvoltage TOV-withstand	UT	180V/5sec.	335V/5sec.	400V/5sec.	500V/5sec.	580V/5sec.
Temporary overvoltage TOV-safe failure	UT	230V/120min.	440V/120min.	520V/120min.	650V/120min.	765V/120min.
Leakage current	IPE	<0.5mA	<0.5mA	<0.5mA	<0.5mA	<0.5mA
Response time	tA	≤25ns	≤25ns	≤25ns	≤25ns	≤25ns
Operating temperature range	Tu	-40°C-80°C	-40°C-80°C	-40°C-80°C	-40°C-80°C	-40°C-80°C
Operating state/fault indication		green/red	green/red	green/red	green/red	green/red
Cross-section area (Min.)		4 mm <sup>2</sup>	4 mm <sup>2</sup>	4 mm <sup>2</sup>	4 mm <sup>2</sup>	4 mm <sup>2</sup>
Cross-section area (Max.)		35mm <sup>2</sup>	35mm <sup>2</sup>	35mm <sup>2</sup>	35mm <sup>2</sup>	35mm <sup>2</sup>
For mounting on	35mm Din rail					
Enclosure material	Thermoplastic UL94-V0					
Degree of protection	IP20	IP20	IP20	IP20	IP20	
Order Code	B16106	B16118	B16130	B16142	B16154	
Order Code (With remote signaling)	B16107	B16119	B16131	B16143	B16155	

## BR-30FU 3P

Type 2 Surge Arrester

Backup fuse built inside the SPD

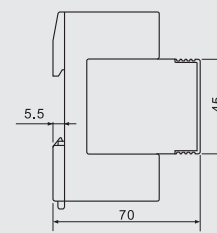
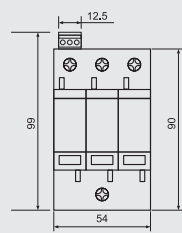
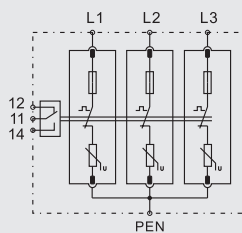
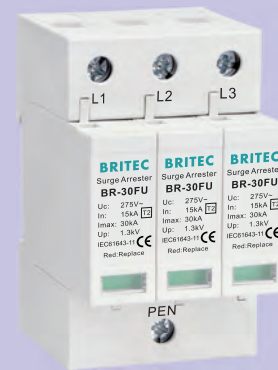

■ BR-30FU 3 pole surge arrester is suitable for TN-C system. No backup fuse or breakers needed.

	BR-30FU 150 3P	BR-30FU 275 3P	BR-30FU 320 3P	BR-30FU 385 3P	BR-30FU 440 3P
SPD classification according to EN61643-11	Type 2	Type 2	Type 2	Type 2	Type 2
SPD classification according to IEC61643-11	Class II	Class II	Class II	Class II	Class II
Max. continuous operating a.c. voltage	Uc	150V	275V	320V	440V
Nominal discharge current (8/20μs)	In	15kA	15kA	15kA	15kA
Max. discharge current (8/20μs)	Imax	30kA	30kA	30kA	30kA
Voltage protection level	Up	≤0.8kV	≤1.3kV	≤1.5kV	≤1.8kV
Voltage protection level 5kA	Up	≤0.6kV	≤1kV	≤1.2kV	≤1.3kV
Short-circuit withstand capacity	ISCCR	25kA	25kA	25kA	25kA
Temporary overvoltage TOV-withstand	UT	180V/5sec.	335V/5sec.	400V/5sec.	500V/5sec.
Temporary overvoltage TOV-safe failure	UT	230V/120min.	440V/120min.	520V/120min.	650V/120min.
Leakage current	IFE	<0.5mA	<0.5mA	<0.5mA	<0.5mA
Response time	tA	≤25ns	≤25ns	≤25ns	≤25ns
Operating temperature range	Tu	-40°C-80°C	-40°C-80°C	-40°C-80°C	-40°C-80°C
Operating state/fault indication		green/red	green/red	green/red	green/red
Cross-section area (Min.)		4 mm <sup>2</sup>	4 mm <sup>2</sup>	4 mm <sup>2</sup>	4 mm <sup>2</sup>
Cross-section area (Max.)		35mm <sup>2</sup>	35mm <sup>2</sup>	35mm <sup>2</sup>	35mm <sup>2</sup>
For mounting on	35mm Din rail				
Enclosure material	Thermoplastic UL94-V0				
Degree of protection	IP20	IP20	IP20	IP20	IP20
Order Code	B16104	B16116	B16128	B16140	B16152
Order Code (With remote signaling)	B16105	B16117	B16129	B16141	B16153

## BR-30FU 2P

### Type 2 Surge Arrester

Backup fuse built inside the SPD

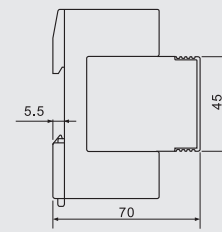
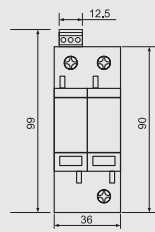
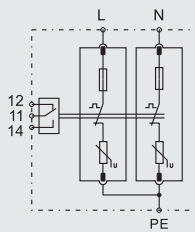

BR-30FU 2 pole surge arrester is suitable for single phase TN system. No backup fuse or breakers needed.

	BR-30FU 150 2P	BR-30FU 275 2P	BR-30FU 320 2P	BR-30FU 385 2P	BR-30FU 440 2P	
SPD classification according to EN61643-11	Type 2	Type 2	Type 2	Type 2	Type 2	
SPD classification according to IEC61643-11	Class II	Class II	Class II	Class II	Class II	
Max. continuous operating a.c. voltage	Uc	150V	275V	320V	385V	440V
Nominal discharge current (8/20μs)	In	15kA	15kA	15kA	15kA	15kA
Max. discharge current (8/20μs)	I <sub>max</sub>	30kA	30kA	30kA	30kA	30kA
Voltage protection level	Up	≤0.8kV	≤1.3kV	≤1.5kV	≤1.8kV	≤2.0kV
Voltage protection level 5kA	Up	≤0.6kV	≤1kV	≤1.2kV	≤1.3kV	≤1.5kV
Short-circuit withstand capacity	I <sub>SCCR</sub>	25kA	25kA	25kA	25kA	25kA
Temporary overvoltage TOV-withstand	U <sub>T</sub>	180V/5sec.	335V/5sec.	400V/5sec.	500V/5sec.	580V/5sec.
Temporary overvoltage TOV-safe failure	U <sub>T</sub>	230V/120min.	440V/120min.	520V/120min.	650V/120min.	765V/120min.
Leakage current	I <sub>PE</sub>	<1mA	<1mA	<1mA	<1mA	<1mA
Response time	t <sub>A</sub>	≤25ns	≤25ns	≤25ns	≤25ns	≤25ns
Operating temperature range	T <sub>u</sub>	-40°C-80°C	-40°C-80°C	-40°C-80°C	-40°C-80°C	-40°C-80°C
Operating state/fault indication		green/red	green/red	green/red	green/red	green/red
Cross-section area (Min.)		4 mm <sup>2</sup>	4 mm <sup>2</sup>	4 mm <sup>2</sup>	4 mm <sup>2</sup>	4 mm <sup>2</sup>
Cross-section area (Max.)		35mm <sup>2</sup>	35mm <sup>2</sup>	35mm <sup>2</sup>	35mm <sup>2</sup>	35mm <sup>2</sup>
For mounting on	35mm Din rail					
Enclosure material	Thermoplastic UL94-V0					
Degree of protection	IP20	IP20	IP20	IP20	IP20	
Order Code	B16102	B16114	B16126	B16138	B16150	
Order Code (With remote signaling)	B16103	B16115	B16127	B16139	B16151	

## BR-30FU 1P

### Type 2 Surge Arrester

Backup fuse built inside the SPD

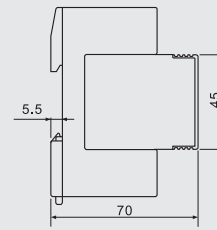
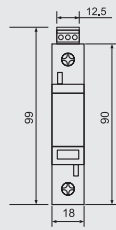
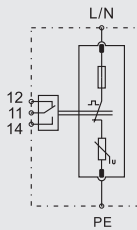

■ BR-30FU 1P can be used to build 2P,3P and 4P surge arresters. No backup fuse or breakers needed.

	BR-30FU 150 1P	BR-30FU 275 1P	BR-30FU 320 1P	BR-30FU 385 1P	BR-30FU 440 1P	
SPD classification according to EN61643-11	Type 2	Type 2	Type 2	Type 2	Type 2	
SPD classification according to IEC61643-11	Class II	Class II	Class II	Class II	Class II	
Max. continuous operating a.c. voltage	Uc	150V	275V	320V	385V	440V
Nominal discharge current (8/20μs)	In	15kA	15kA	15kA	15kA	15kA
Max. discharge current (8/20μs)	I <sub>max</sub>	30kA	30kA	30kA	30kA	30kA
Voltage protection level	Up	≤0.8kV	≤1.3kV	≤1.5kV	≤1.8kV	≤2.0kV
Voltage protection level 5kA	Up	≤0.6kV	≤1kV	≤1.2kV	≤1.3kV	≤1.5kV
Short-circuit withstand capacity	I <sub>SCCR</sub>	25kA	25kA	25kA	25kA	25kA
Temporary overvoltage TOV-withstand	U <sub>T</sub>	180V/5sec.	335V/5sec.	400V/5sec.	500V/5sec.	580V/5sec.
Temporary overvoltage TOV-safe failure	U <sub>T</sub>	230V/120min.	440V/120min.	520V/120min.	650V/120min.	765V/120min.
Leakage current	I <sub>PE</sub>	<1mA	<1mA	<1mA	<1mA	<1mA
Response time	t <sub>A</sub>	≤25ns	≤25ns	≤25ns	≤25ns	≤25ns
Operating temperature range	T <sub>u</sub>	-40°C-80°C	-40°C-80°C	-40°C-80°C	-40°C-80°C	-40°C-80°C
Operating state/fault indication		green/red	green/red	green/red	green/red	green/red
Cross-section area (Min.)		4 mm <sup>2</sup>	4 mm <sup>2</sup>	4 mm <sup>2</sup>	4 mm <sup>2</sup>	4 mm <sup>2</sup>
Cross-section area (Max.)		35mm <sup>2</sup>	35mm <sup>2</sup>	35mm <sup>2</sup>	35mm <sup>2</sup>	35mm <sup>2</sup>
For mounting on	35mm Din rail					
Enclosure material	Thermoplastic UL94-V0					
Degree of protection	IP20	IP20	IP20	IP20	IP20	
Order Code	B16100	B16112	B16124	B16136	B16148	
Order Code (With remote signaling)	B16101	B16113	B16125	B16137	B16149	

## BR-30FU 3+1

### Type 2 Surge Arrester

Backup fuse built inside the SPD

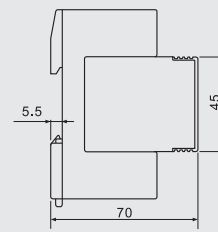
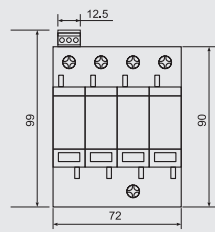
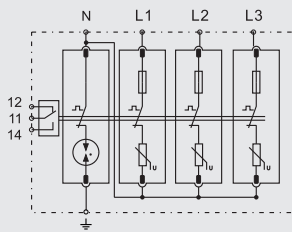

■ BR-30FU 3+1 surge arrester is suitable for TT and TN-S system. No backup fuse or breakers needed.

	BR-30FU 150 3+1	BR-30FU 275 3+1	BR-30FU 320 3+1	BR-30FU 385 3+1	BR-30FU 440 3+1
SPD classification according to EN61643-11	Type 2	Type 2	Type 2	Type 2	Type 2
SPD classification according to IEC61643-11	Class II	Class II	Class II	Class II	Class II
Max. continuous operating a.c. voltage [L-N] U <sub>c</sub>	150V	275V	320V	385V	440V
Max. continuous operating a.c. voltage [N-PE] U <sub>c</sub>	255V	255V	255V	255V	255V
Nominal discharge current (8/20μs) <sub>[L-N/N-PE]</sub> I <sub>n</sub>	15kA/20kA	15kA/20kA	15kA/20kA	15kA/20kA	15kA/20kA
Max. discharge current (8/20μs) <sub>[L-N/N-PE]</sub> I <sub>max</sub>	30kA/40kA	30kA/40kA	30kA/40kA	30kA/40kA	30kA/40kA
Voltage protection level [L-N] U <sub>p</sub>	≤0.8kV	≤1.3kV	≤1.5kV	≤1.8kV	≤2.0kV
Voltage protection level 5kA [L-N] U <sub>p</sub>	≤0.6kV	≤1kV	≤1.2kV	≤1.3kV	≤1.5kV
Voltage protection level [N-PE] U <sub>p</sub>	≤1.5kV	≤1.5kV	≤1.5kV	≤1.5kV	≤1.5kV
Short-circuit withstand capacity I <sub>SCCR</sub>	25kA	25kA	25kA	25kA	25kA
Temporary overvoltage TOV-withstand [L-N] U <sub>T</sub>	180V/5sec.	335V/5sec.	400V/5sec.	500V/5sec.	580V/5sec.
Temporary overvoltage TOV-safe failure [L-N] U <sub>T</sub>	230V/120min.	440V/120min.	520V/120min.	650V/120min.	765V/120min.
Temporary overvoltage TOV-withstand [N-PE] U <sub>T</sub>	1200V/200ms	1200V/200ms	1200V/200ms	1200V/200ms	1200V/200ms
Follow current extinguishing capability a.c. [N-PE] I <sub>fi</sub>	100Arms	100Arms	100Arms	100Arms	100Arms
Leakage current I <sub>PE</sub>	None	None	None	None	None
Response time [L-N] t <sub>A</sub>	≤25ns	≤25ns	≤25ns	≤25ns	≤25ns
Response time [N-PE] t <sub>A</sub>	≤100ns	≤100ns	≤100ns	≤100ns	≤100ns
Operating temperature range T <sub>u</sub>	-40°C-80°C	-40°C-80°C	-40°C-80°C	-40°C-80°C	-40°C-80°C
Operating state/fault indication	green/red	green/red	green/red	green/red	green/red
Cross-section area (Min.)	4 mm <sup>2</sup>	4 mm <sup>2</sup>	4 mm <sup>2</sup>	4 mm <sup>2</sup>	4 mm <sup>2</sup>
Cross-section area (Max.)	35mm <sup>2</sup>	35mm <sup>2</sup>	35mm <sup>2</sup>	35mm <sup>2</sup>	35mm <sup>2</sup>
For mounting on	35mm Din rail				
Enclosure material	Thermoplastic UL94-V0				
Degree of protection	IP20	IP20	IP20	IP20	IP20
Order Code	B16110	B16122	B16134	B16146	B16158
Order Code (With remote signaling)	B16111	B16123	B16135	B16147	B16159

## BR-30FU 1+1

Type 2 Surge Arrester

Backup fuse built inside the SPD

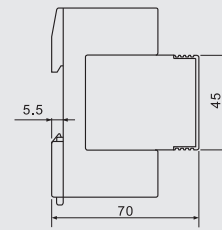
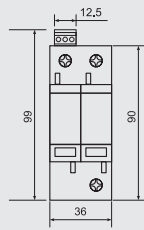
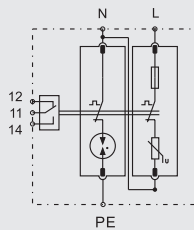
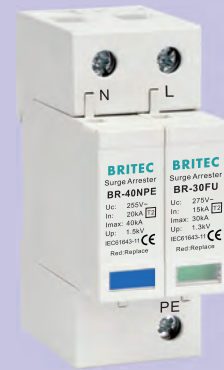

BR-30FU 1+1 surge arrester is suitable for single phase TT and TN system. No backup fuse or breakers needed.

	BR-30FU 150 1+1	BR-30FU 275 1+1	BR-30FU 320 1+1	BR-30FU 385 1+1	BR-30FU 440 1+1
SPD classification according to EN61643-11	Type 2	Type 2	Type 2	Type 2	Type 2
SPD classification according to IEC61643-11	Class II	Class II	Class II	Class II	Class II
Max. continuous operating a.c. voltage [L-N] U <sub>c</sub>	150V	275V	320V	385V	440V
Max. continuous operating a.c. voltage [N-PE] U <sub>c</sub>	255V	255V	255V	255V	255V
Nominal discharge current (8/20μs) <sub>[L-N/N-PE]</sub> I <sub>n</sub>	15kA/20kA	15kA/20kA	15kA/20kA	15kA/20kA	15kA/20kA
Max. discharge current (8/20μs) <sub>[L-N/N-PE]</sub> I <sub>max</sub>	30kA/40kA	30kA/40kA	30kA/40kA	30kA/40kA	30kA/40kA
Voltage protection level [L-N] U <sub>p</sub>	≤0.8kV	≤1.3kV	≤1.5kV	≤1.8kV	≤2.0kV
Voltage protection level 5kA [L-N] U <sub>p</sub>	≤0.6kV	≤1kV	≤1.2kV	≤1.3kV	≤1.5kV
Voltage protection level [N-PE] U <sub>p</sub>	≤1.5kV	≤1.5kV	≤1.5kV	≤1.5kV	≤1.5kV
Short-circuit withstand capacity I <sub>SCCR</sub>	25kA	25kA	25kA	25kA	25kA
Temporary overvoltage TOV-withstand [L-N] U <sub>T</sub>	180V/5sec.	335V/5sec.	400V/5sec.	500V/5sec.	580V/5sec.
Temporary overvoltage TOV-safe failure [L-N] U <sub>T</sub>	230V/120min.	440V/120min.	520V/120min.	650V/120min.	765V/120min.
Temporary overvoltage TOV-withstand [N-PE] U <sub>T</sub>	1200V/200ms	1200V/200ms	1200V/200ms	1200V/200ms	1200V/200ms
Follow current extinguishing capability a.c. [N-PE] I <sub>fi</sub>	100Arms	100Arms	100Arms	100Arms	100Arms
Leakage current I <sub>PE</sub>	None	None	None	None	None
Response time [L-N] t <sub>A</sub>	≤25ns	≤25ns	≤25ns	≤25ns	≤25ns
Response time [N-PE] t <sub>A</sub>	≤100ns	≤100ns	≤100ns	≤100ns	≤100ns
Operating temperature range T <sub>u</sub>	-40°C-80°C	-40°C-80°C	-40°C-80°C	-40°C-80°C	-40°C-80°C
Operating state/fault indication	green/red	green/red	green/red	green/red	green/red
Cross-section area (Min.)	4 mm <sup>2</sup>	4 mm <sup>2</sup>	4 mm <sup>2</sup>	4 mm <sup>2</sup>	4 mm <sup>2</sup>
Cross-section area (Max.)	35mm <sup>2</sup>	35mm <sup>2</sup>	35mm <sup>2</sup>	35mm <sup>2</sup>	35mm <sup>2</sup>
For mounting on	35mm Din rail				
Enclosure material	Thermoplastic UL94-V0				
Degree of protection	IP20	IP20	IP20	IP20	IP20
Order Code	B16108	B16120	B16132	B16144	B16156
Order Code (With remote signaling)	B16109	B16121	B16133	B16145	B16157



## Type 2+3 Surge Arrester

[www.britecelectric.com](http://www.britecelectric.com)

## BR-40DP

### Type 2+3 Surge Arrester

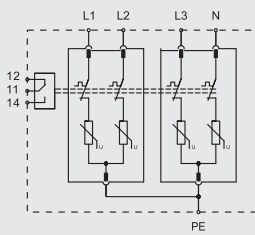

BR-40DP 4P

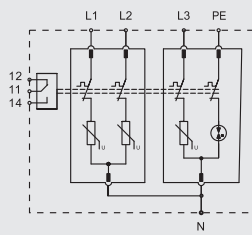

BR-40DP 3+1

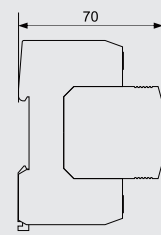
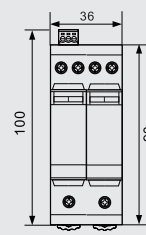

■ Type 2+Type 3 surge arrester is installed between LPZ1 and LPZ2, it can provide type 3 protection for equipments which installed within 5 meters from these devices.

	BR-275 40DP 4	BR-320 40DP 4	BR-275 40DP 3+1	BR-320 40DP 3+1	
SPD classification according to EN61643-11	Type 2+Type 3	Type 2+Type 3	Type 2+Type 3	Type 2+Type 3	
SPD classification according to IEC61643-11	Class II+Class III	Class II+Class III	Class II+Class III	Class II+Class III	
Max. continuous operating a.c. voltage	Uc	275V	320V	275V	320V
Nominal discharge current (8/20μs)	In	20kA	20kA	20kA	20kA
Max. discharge current (8/20μs)	I <sub>max</sub>	40kA	40kA	40kA	40kA
Voltage protection level	Up	≤1.3kV	≤1.5kV	≤1.3kV/1.5kV	≤1.5kV/1.5kV
Voltage protection level 5kA	Up	≤1.0kV	≤1.2kV	≤1.0kV/1.5kV	≤1.2kV/1.5kV
Combined impulse	Uoc	10kV	10kV	10kV	10kV
Max. backup fuse		100A gG	100A gG	100A gG	100A gG
Short-circuit withstand capacity	I <sub>SCCR</sub>	25kA	25kA	25kA	25kA
Temporary overvoltage TOV-withstand	U <sub>T</sub>	335V/5sec.	400V/5sec.	335V/5sec.	400V/5sec.
Temporary overvoltage TOV-safe failure	U <sub>T</sub>	440V/120min.	520V/120min.	440V/120min.	520V/120min.
Leakage current	I <sub>PE</sub>	<0.5mA	<0.5mA	None	None
Response time	t <sub>A</sub>	≤25ns	≤25ns	≤25ns/≤100ns	≤25ns/≤100ns
Operating temperature range	T <sub>u</sub>	-40°C-80°C	-40°C-80°C	-40°C-80°C	-40°C-80°C
Operating state/fault indication		green/red	green/red	green/red	green/red
Cross-section area (Min.)		2.5 mm <sup>2</sup>	2.5 mm <sup>2</sup>	2.5 mm <sup>2</sup>	2.5 mm <sup>2</sup>
Cross-section area (Max.)		16 mm <sup>2</sup>	16 mm <sup>2</sup>	16 mm <sup>2</sup>	16 mm <sup>2</sup>
For mounting on		35mm Din rail			
Enclosure material		Thermoplastic UL94-V0			
Degree of protection		IP20	IP20	IP20	IP20
Order Code		B18220	B17250	B18243	B17254
Order Code (With remote signaling)		B18221	B17251	B18244	B17255

## BR-40DP

### Type 2+3 Surge Arrester

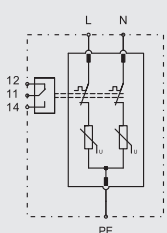

BR-40DP 2P

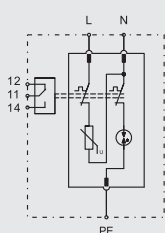

BR-40DP 1+1

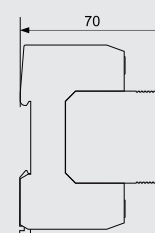
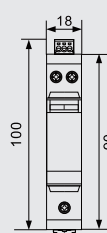

■ Type 2+Type 3 surge arrester is installed between LPZ1 and LPZ2, it can provide type 3 protection for equipments which installed within 5 meters from these devices.

	BR-275 40DP 2	BR-320 40DP 2	BR-275 40DP 1+1	BR-320 40DP 1+1	
SPD classification according to EN61643-11	Type 2+Type 3	Type 2+Type 3	Type 2+Type 3	Type 2+Type 3	
SPD classification according to IEC61643-11	Class II+Class III	Class II+Class III	Class II+Class III	Class II+Class III	
Max. continuous operating a.c. voltage	Uc	275V	320V	275V	320V
Nominal discharge current (8/20μs)	In	20kA	20kA	20kA	20kA
Max. discharge current (8/20μs)	I <sub>max</sub>	40kA	40kA	40kA	40kA
Voltage protection level	Up	≤1.3kV	≤1.5kV	≤1.3kV/1.5kV	≤1.5kV/1.5kV
Voltage protection level 5kA	Up	≤1.0kV	≤1.2kV	≤1.0kV/1.5kV	≤1.2kV/1.5kV
Combined impulse	Uoc	10kV	10kV	10kV	10kV
Max. backup fuse		100A gG	100A gG	100A gG	100A gG
Short-circuit withstand capacity	I <sub>SCCR</sub>	25kA	25kA	25kA	25kA
Temporary overvoltage TOV-withstand	U <sub>T</sub>	335V/5sec.	400V/5sec.	335V/5sec.	400V/5sec.
Temporary overvoltage TOV-safe failure	U <sub>T</sub>	440V/120min.	520V/120min.	440V/120min.	520V/120min.
Leakage current	I <sub>PE</sub>	<1mA	<1mA	None	None
Response time	t <sub>A</sub>	≤25ns	≤25ns	≤25ns/≤100ns	≤25ns/≤100ns
Operating temperature range	T <sub>u</sub>	-40°C-80°C	-40°C-80°C	-40°C-80°C	-40°C-80°C
Operating state/fault indication		green/red	green/red	green/red	green/red
Cross-section area (Min.)		2.5 mm <sup>2</sup>	2.5 mm <sup>2</sup>	2.5 mm <sup>2</sup>	2.5 mm <sup>2</sup>
Cross-section area (Max.)		16 mm <sup>2</sup>	16 mm <sup>2</sup>	16 mm <sup>2</sup>	16 mm <sup>2</sup>
For mounting on	35mm Din rail				
Enclosure material	Thermoplastic UL94-V0				
Degree of protection	IP20	IP20	IP20	IP20	
Order Code	B18241	B17252	B18245	B17256	
Order Code (With remote signaling)	B18242	B17253	B18246	B17257	

## BR-20DP

### Type 2+3 Surge Arrester

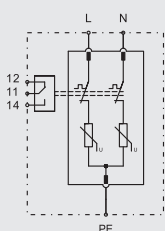

BR-20DP 2P

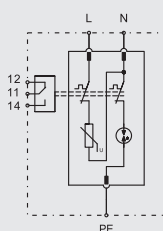

BR-20DP 1+1

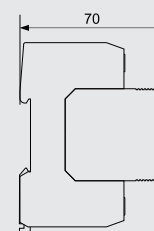
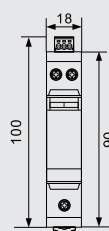

■ Type 3 surge arrester is installed between LPZ2 and LPZ3, it can provide protection for equipments.

		BR275-20DP 2	BR320-20DP 2	BR275-20DP 1+1	BR320-20DP 1+1
SPD classification according to EN61643-11		Type 2+Type 3	Type 2+Type 3	Type 2+Type 3	Type 2+Type 3
SPD classification according to IEC61643-11		Class II+Class III	Class II+Class III	Class II+Class III	Class II+Class III
Max. continuous operating a.c. voltage	Uc	275V	320V	275V	320V
Nominal discharge current (8/20μs)	In	10kA	10kA	10kA	10kA
Max. discharge current (8/20μs)	Imax	20kA	20kA	20kA	20kA
Voltage protection level	Up	≤1.2kV	≤1.2kV	≤1.2kV	≤1.2kV
Combined impulse	Uoc	10kV	10kV	10kV	10kV
Max. backup fuse		63A gG	63A gG	63A gG	63A gG
Short-circuit withstand capacity	ISCCR	25kA	25kA	25kA	25kA
Temporary overvoltage TOV-withstand	UT	335V/5sec.	400V/5sec.	335V/5sec.	400V/5sec.
Temporary overvoltage TOV-safe failure	UT	440V/120min.	520V/120min.	440V/120min.	520V/120min.
Leakage current	IPE	<1mA	<1mA	None	None
Response time	tA	≤25ns	≤25ns	≤25ns/≤100ns	≤25ns/≤100ns
Operating temperature range	Tu	-40°C-80°C	-40°C-80°C	-40°C-80°C	-40°C-80°C
Operating state/fault indication		green/red	green/red	green/red	green/red
Cross-section area (Min.)		2.5 mm <sup>2</sup>	2.5 mm <sup>2</sup>	2.5 mm <sup>2</sup>	2.5 mm <sup>2</sup>
Cross-section area (Max.)		16 mm <sup>2</sup>	16 mm <sup>2</sup>	16 mm <sup>2</sup>	16 mm <sup>2</sup>
For mounting on		35mm Din rail			
Enclosure material		Thermoplastic UL94-V0			
Degree of protection		IP20	IP20	IP20	IP20
Order Code		B18339	B6400	B18347	B6402
Order Code (with remote signal)		B18340	B6401	B18348	B6403



## Type 3 Surge Arrester

## BR-T3

### Type 3 Surge Arrester

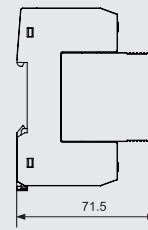
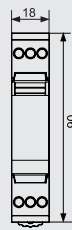
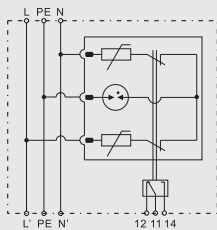

■ Type 3 surge arrester is installed between LPZ2 and LPZ3, it can provide protection for equipments.

		BR-T3 30 2P	BR-T3 75 2P	BR-T3 150 2P	BR-T3 275 2P
SPD classification according to EN61643-11		Type 3	Type 3	Type 3	Type 3
SPD classification according to IEC61643-11		Class III	Class III	Class III	Class III
Nominal a.c. voltage	U <sub>n</sub>	24V	60V	120V	230V
Max. continuous operating a.c. voltage	U <sub>c</sub>	30V	75V	150V	275V
Max. continuous operating d.c. voltage	U <sub>c</sub>	38V	100V	190V	300V
Nominal discharge current (8/20μs)	I <sub>n</sub>	5kA	5kA	5kA	5kA
Combined impulse	U <sub>oc</sub>	10kV	10kV	10kV	10kV
Nominal load current a.c.	I <sub>L</sub>	25A	25A	25A	25A
Voltage protection level	U <sub>p</sub>	≤630V	≤730V	≤800V	≤1500V
Max. over current protection		25A gG	25A gG	25A gG	25A gG
Short-circuit withstand capacity	I <sub>SCCR</sub>	10kA	10kA	10kA	10kA
Leakage current	I <sub>PE</sub>	None	None	None	None
Response time (L-N / L/N-PE)	t <sub>A</sub>	≤25ns/100ns	≤25ns/100ns	≤25ns/100ns	≤25ns/100ns
Operating temperature range	T <sub>u</sub>	-40°C-80°C	-40°C-80°C	-40°C-80°C	-40°C-80°C
Operating state/fault indication		green/red	green/red	green/red	green/red
Cross-section area (Min.)		1 mm <sup>2</sup>			
Cross-section area (Max.)		4.0mm <sup>2</sup> solid/2.5mm <sup>2</sup> flexible			
For mounting on		35mm Din rail			
Enclosure material		Thermoplastic UL94-V0			
Degree of protection		IP20	IP20	IP20	IP20
Order Code		B18237	B18235	B18359	B18231
Order Code (with remote signal)		B18238	B18236	B18234	B18232

## BR275-6

### Type 3 Surge Arrester

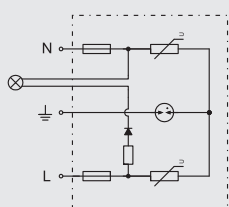

BR275-6-L

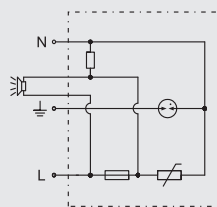
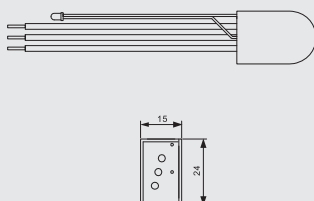

BR275-6-B

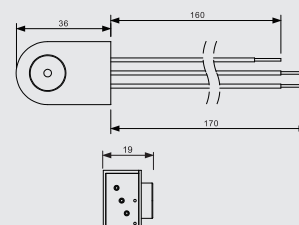

■ Type 3 surge arrester is installed between LPZ2 and LPZ3, it can provide protection for equipments.

		BR275-6-L	BR275-6-B
SPD classification according to EN61643-11		Type 3	Type 3
SPD classification according to IEC61643-11		Class III	Class III
Nominal a.c. voltage	Un	230V	230V
Max. continuous operating a.c. voltage	Uc	275V	275V
Max. continuous operating d.c. voltage	Uc	300V	300V
Nominal discharge current (8/20μs)	In	3kA	3kA
Combined impulse	Uoc	6kV	6kV
Voltage protection level	Up	≤1.3kV	≤1.3kV
Response time	tA	≤25ns	≤25ns
Operating temperature range	Tu	-40°C-80°C	-40°C-80°C
Operating state/fault indication		LED	BEEP
For mounting on		35mm Din rail	35mm Din rail
Enclosure materail		Thermoplastic UL94-V0	Thermoplastic UL94-V0
Degree of protection		IP20	IP20
Order Code		B8355	B8357

## BRLED-06SC

### Surge Arresters for LED

BRLED-06SC-VG  
BRLED-06SC-NG  
BRLED-06SC-TT

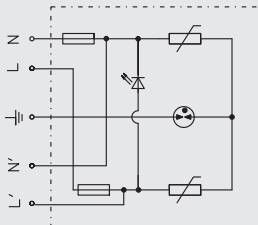

BRLED-06SC-VG

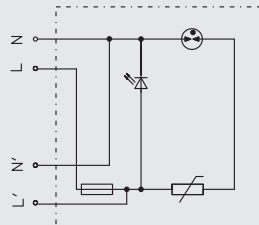

BRLED-06SC-NG

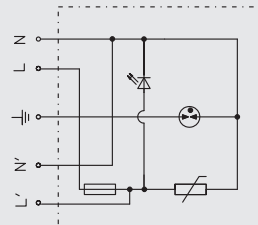

BRLED-06SC-TT

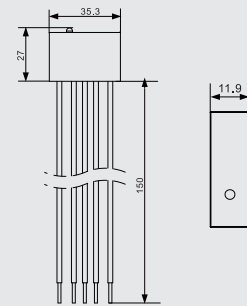

		BRLED-06SC-VG	BRLED-06SC-NG	BRLED-06SC-TT
SPD classification according to EN61643-11		Type 2+Type 3	Type 2+Type 3	Type 2+Type 3
SPD classification according to IEC61643-11		Class II+Class III	Class II+Class III	Class II+Class III
Nominal a.c. voltage	Un	230V	230V	230V
Max. continuous operating a.c. voltage	Uc	275V	275V	275V
Frequency		50-60Hz	50-60Hz	50-60Hz
Nominal discharge current (8/20μs)	In	3kA	3kA	3kA
Max. discharge current (8/20μs)	I <sub>max</sub>	6kA	6kA	6kA
Max. Load	I <sub>L</sub>	2.5A	2.5A	2.5A
Combined impulse	U <sub>oc</sub>	6kV	6kV	6kV
Voltage protection level	U <sub>p</sub>	≤ 1.3kV	≤ 1.3kV	≤ 1.3kV
Response time	t <sub>A</sub>	≤ 100ns	≤ 100ns	≤ 100ns
Operating temperature range	T <sub>u</sub>	-40°C-80°C	-40°C-80°C	-40°C-80°C
Operating state		Green light on: OK, Green light off: Replace		
Enclosure material		Thermoplastic UL94-V0		
Degree of protection		IP 65		
Order Code		B6024	B6025	B6026

## BRLED-06P

### Surge Arresters for LED

BRLED-06P-VG  
BRLED-06P-NG  
BRLED-06P-TT

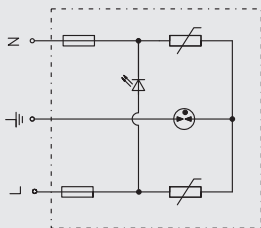

BRLED-06P-VG

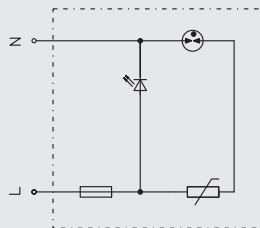

BRLED-06P-NG

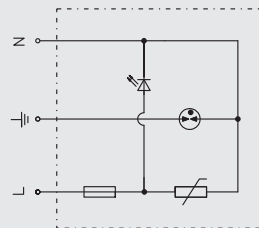

BRLED-06P-TT

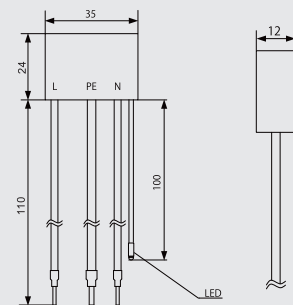

		BRLED-06P-VG	BRLED-06P-NG	BRLED-06P-TT
SPD classification according to EN61643-11		Type 2+Type 3	Type 2+Type 3	Type 2+Type 3
SPD classification according to IEC61643-11		Class II+Class III	Class II+Class III	Class II+Class III
Nominal a.c. voltage	Un	230V	230V	230V
Max. continuous operating a.c. voltage	Uc	275V	275V	275V
Frequency		50-60Hz	50-60Hz	50-60Hz
Nominal discharge current (8/20μs)	In	3kA	3kA	3kA
Max. discharge current (8/20μs)	I <sub>max</sub>	6kA	6kA	6kA
Combined impulse	Uoc	6kV	6kV	6kV
Voltage protection level	Up	≤1.3kV	≤1.3kV	≤1.3kV
Response time	t <sub>A</sub>	≤100ns	≤100ns	≤100ns
Operating temperature range	Tu	-40°C-80°C	-40°C-80°C	-40°C-80°C
Operating state		Green light on: OK, Green light off: Replace		
Enclosure material		Thermoplastic UL94-V0		
Degree of protection		IP 65		
Order Code		B6021	B6022	B6023

## BRLED-10SC

### Surge Arresters for LED

BRLED-10SC-VG  
BRLED-10SC-NG  
BRLED-10SC-TT

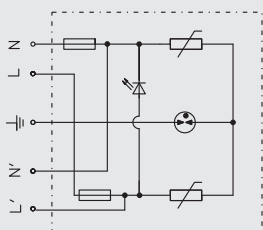
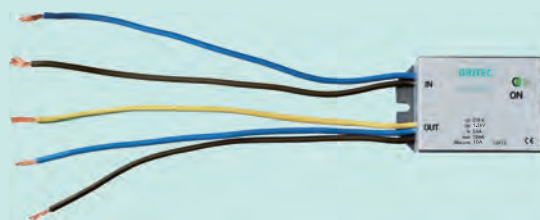

BRLED-10SC-VG

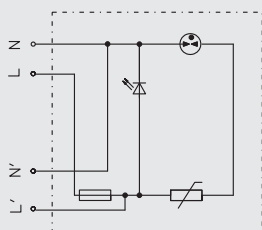

BRLED-10SC-NG

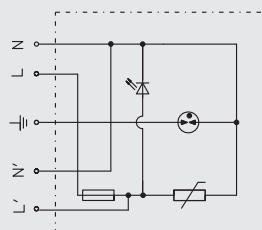

BRLED-10SC-TT

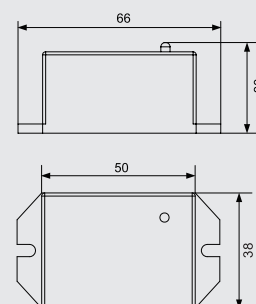

		BRLED-10SC-VG	BRLED-10SC-NG	BRLED-10SC-TT
SPD classification according to EN61643-11		Type 2+Type 3	Type 2+Type 3	Type 2+Type 3
SPD classification according to IEC61643-11		Class II+Class III	Class II+Class III	Class II+Class III
Nominal a.c. voltage	Un	230V	230V	230V
Max. continuous operating a.c. voltage	Uc	275V	275V	275V
Frequency		50-60Hz	50-60Hz	50-60Hz
Nominal discharge current (8/20μs)	In	5kA	5kA	5kA
Max. discharge current (8/20μs)	I <sub>max</sub>	10kA	10kA	10kA
Max. Load	I <sub>L</sub>	10A	10A	10A
Combined impulse	U <sub>oc</sub>	10kV	10kV	10kV
Voltage protection level	U <sub>p</sub>	≤1.3kV	≤1.3kV	≤1.3kV
Response time	t <sub>A</sub>	≤100ns	≤100ns	≤100ns
Operating temperature range	T <sub>u</sub>	-40°C-80°C	-40°C-80°C	-40°C-80°C
Operating state		Green light on: OK, Green light off: Replace		
Enclosure material		Thermoplastic UL94-V0		
Degree of protection		IP 65		
Order Code		B6029	B6030	B6031

## BRLED-10P

### Surge Arresters for LED

BRLED-10P-VG  
BRLED-10P-NG  
BRLED-10P-TT

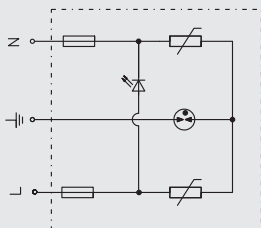

BRLED-10P-VG

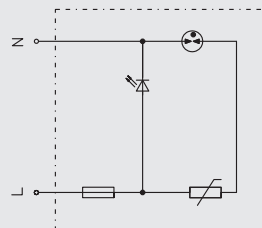

BRLED-10P-NG

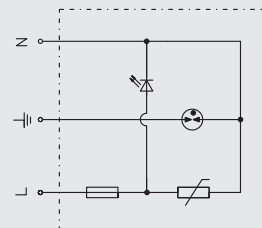

BRLED-10P-TT

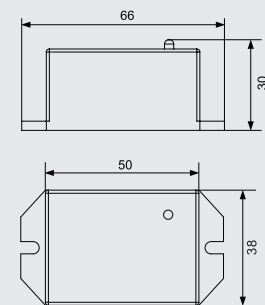

		BRLED-10P-VG	BRLED-10P-NG	BRLED-10P-TT
SPD classification according to EN61643-11		Type 2+Type 3	Type 2+Type 3	Type 2+Type 3
SPD classification according to IEC61643-11		Class II+Class III	Class II+Class III	Class II+Class III
Nominal a.c. voltage	Un	230V	230V	230V
Max. continuous operating a.c. voltage	Uc	275V	275V	275V
Frequency		50-60Hz	50-60Hz	50-60Hz
Nominal discharge current (8/20μs)	In	5kA	5kA	5kA
Max. discharge current (8/20μs)	I <sub>max</sub>	10kA	10kA	10kA
Combined impulse	Uoc	10kV	10kV	10kV
Voltage protection level	Up	≤1.3kV	≤1.3kV	≤1.3kV
Response time	t <sub>A</sub>	≤100ns	≤100ns	≤100ns
Operating temperature range	Tu	-40°C-80°C	-40°C-80°C	-40°C-80°C
Operating state		Green light on: OK, Green light off: Replace		
Enclosure material		Thermoplastic UL94-V0		
Degree of protection		IP 65		
Order Code		B6032	B6033	B6034

## BRRL-SC

Surge Arresters for LED

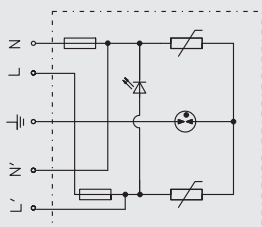

BRRL-SC-VG

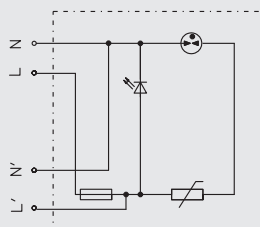

BRRL-SC-NG

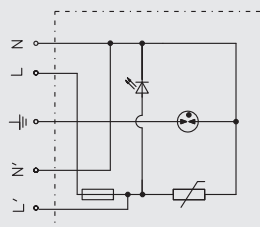

BRRL-SC-TT

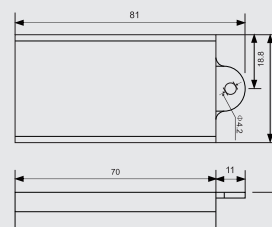

		BRRL-SC-VG	BRRL-SC-NG	BRRL-SC-TT
SPD classification according to EN61643-11		Type 2+Type 3	Type 2+Type 3	Type 2+Type 3
SPD classification according to IEC61643-11		Class II+Class III	Class II+Class III	Class II+Class III
Nominal a.c. voltage	Un	230V	230V	230V
Max. continuous operating a.c. voltage	Uc	275V	275V	275V
Frequency		50-60Hz	50-60Hz	50-60Hz
Nominal discharge current (8/20μs)	In	5kA	5kA	5kA
Max. discharge current (8/20μs)	I <sub>max</sub>	20kA	20kA	20kA
Max. Load	IL	15A	15A	15A
Combined impulse	Uoc	10kV	10kV	10kV
Voltage protection level	Up	≤1.3kV	≤1.3kV	≤1.3kV
Response time	t <sub>A</sub>	≤100ns	≤100ns	≤100ns
Operating temperature range	Tu	-40°C-80°C	-40°C-80°C	-40°C-80°C
Operating state		Green light on: OK, Green light off: Replace		
Enclosure material		Thermoplastic UL94-V0		
Degree of protection		IP 65		
Order Code		B6014	B6015	B6016

## BRRL-P

Surge Arresters for LED

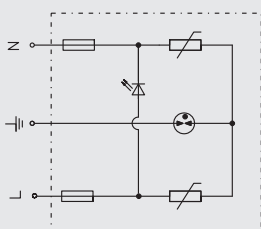

BRRL-P-VG

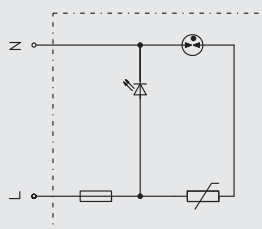

BRRL-P-NG

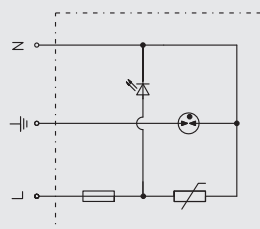

BRRL-P-TT

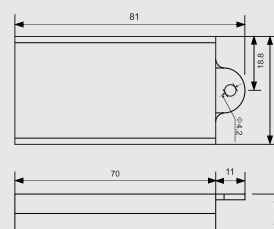

		BRRL-P-VG	BRRL-P-NG	BRRL-P-TT
SPD classification according to EN61643-11		Type 2+Type 3	Type 2+Type 3	Type 2+Type 3
SPD classification according to IEC61643-11		Class II+Class III	Class II+Class III	Class II+Class III
Nominal a.c. voltage	Un	230V	230V	230V
Max. continuous operating a.c. voltage	Uc	275V	275V	275V
Frequency		50-60Hz	50-60Hz	50-60Hz
Nominal discharge current (8/20μs)	In	5kA	5kA	5kA
Max. discharge current (8/20μs)	I <sub>max</sub>	20kA	20kA	20kA
Combined impulse	Uoc	10kV	10kV	10kV
Voltage protection level	Up	≤1.3kV	≤1.3kV	≤1.3kV
Response time	t <sub>A</sub>	≤100ns	≤100ns	≤100ns
Operating temperature range	Tu	-40°C-80°C	-40°C-80°C	-40°C-80°C
Operating state		Green light on: OK, Green light off: Replace		
Enclosure material		Thermoplastic UL94-V0		
Degree of protection		IP 65		
Order Code		B6011	B6012	B6013

## BRLED-08AST-10

Surge Arresters for LED

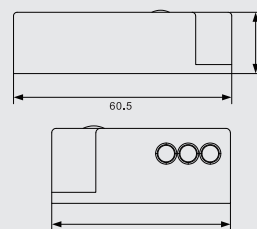
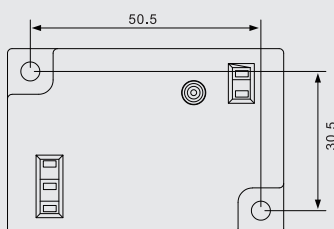
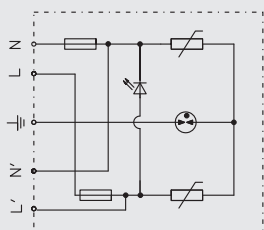

		BRLED-08AST-10
SPD classification according to EN61643-11		Type 2+Type 3
SPD classification according to IEC61643-11		Class II+Class III
Nominal a.c. voltage	Un	230V
Max. continuous operating a.c. voltage	Uc	305V
Frequency		50-60Hz
Nominal discharge current (8/20μs)	In	5kA
Max. discharge current (8/20μs)	I <sub>max</sub>	10kA
Max. Load	IL	10A
Combined impulse	Uoc	10kV
Voltage protection level	Up	≤1.5kV
Response time	t <sub>A</sub>	≤100ns
Operating temperature range	Tu	-40°C-80°C
Operating state		Green light on: OK/ Light off: Replace
Maximum cable size		Solid cable 2.5mm <sup>2</sup>
Stripping length		14mm
Mounting type		Self-tapping screw
Enclosure material		Thermoplastic UL94-V0
Degree of protection		IP20
Order Code		B6027

## BRLED-08ASC-10

Surge Arresters for LED

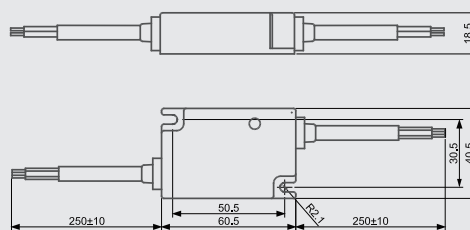
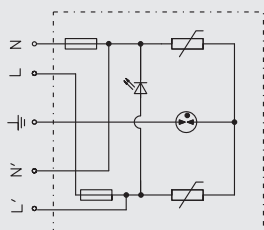

		BRLED-08ASC-10
SPD classification according to EN61643-11		Type 2+Type 3
SPD classification according to IEC61643-11		Class II+Class III
Nominal a.c. voltage	Un	230V
Max. continuous operating a.c. voltage	Uc	305V
Frequency		50-60Hz
Nominal discharge current (8/20µs)	In	5kA
Max. discharge current (8/20µs)	I <sub>max</sub>	10kA
Max. Load	IL	10A
Combined impulse	Uoc	10kV
Voltage protection level	Up	≤ 1.5kV
Response time	t <sub>A</sub>	≤ 100ns
Operating temperature range	Tu	-40°C-80°C
Operating state		Green light on: OK/ Light off: Replace
Enclosure material		Thermoplastic UL94-V0
Degree of protection		IP 65
Order Code		B6028

## BRLED-DIN

Surge Arresters for LED

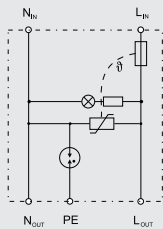

BRLED-DIN

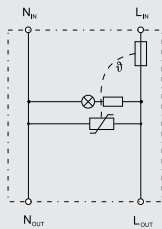

BRLED-DIN-NG

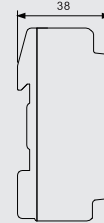
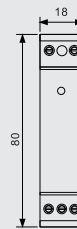

		BRLED-DIN	BRLED-DIN-NG
SPD classification according to EN61643 -11		Type 2+Type 3	Type 2+Type 3
SPD classification according to IEC61643-11		Class II+Class III	Class II+Class III
Nominal a.c. voltage	Un	230V	230V
Max. continuous operating a.c. voltage	Uc	320V	320V
Nominal discharge current (8/20µs)	In	5kA	5kA
Max. discharge current (8/20µs)	Imax	10kA	10kA
Voltage protection level	Up	≤1.5kV	≤1.5kV
Nominal current	IL	5A	5A
Combined impulse	Uoc	10kV	10kV
Response time	tA	≤25ns	≤25ns
Operating temperature range	Tu	-40°C-80°C	-40°C-80°C
Operating state/fault indication		Green light on: OK / light off: Replace	Green light on: OK / light off: Replace
For mounting on		35mm Din rail	35mm Din rail
Enclosure material		Thermoplastic UL94-V0	Thermoplastic UL94-V0
Degree of protection		IP20	IP20
Order Code		B6017	B6018

## BRLED-DIN-MD

Surge Arresters for LED  
With mechanical indicator

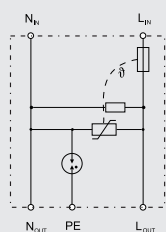

BRLED-DIN-MD

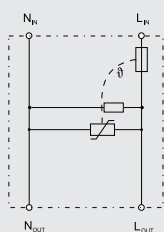

BRLED-DIN-MD-NG

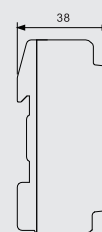
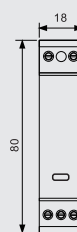

		BRLED-DIN-MD	BRLED-DIN-MD-NG
SPD classification according to EN61643 -11		Type 2+Type 3	Type 2+Type 3
SPD classification according to IEC61643-11		Class II+Class III	Class II+Class III
Nominal a.c. voltage	Un	230V	230V
Max. continuous operating a.c. voltage	Uc	320V	320V
Nominal discharge current (8/20µs)	In	5kA	5kA
Max. discharge current (8/20µs)	I <sub>max</sub>	10kA	10kA
Voltage protection level	Up	≤1.5kV	≤1.5kV
Nominal current	IL	5A	5A
Combined impulse	Uoc	10kV	10kV
Response time	t <sub>A</sub>	≤25ns	≤25ns
Operating temperature range	Tu	-40°C-80°C	-40°C-80°C
Operating state/fault indication		green/red	green/red
For mounting on		35mm Din rail	35mm Din rail
Enclosure material		Thermoplastic UL94-V0	Thermoplastic UL94-V0
Degree of protection		IP20	IP20
Order Code		B6019	B6020



## DC Surge Arrester for pv

## BRPV3

Type 2 DC Surge Arrester for PV

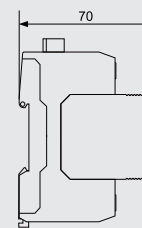
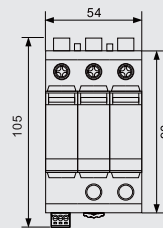
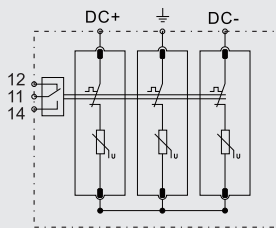
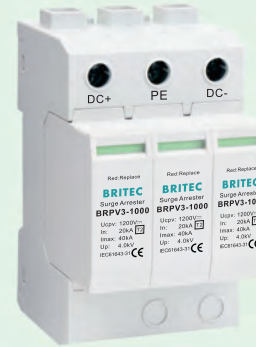

3 Mod		BRPV3-600	BRPV3-1000	BRPV3-1500
SPD classification according to EN61643-31/IEC61643-31		Type 2 / Class II	Type 2 / Class II	Type 2 / Class II
Max. continuous operating dc voltage	Ucpv	600V	1200V	1500V
Nominal discharge current (8/20μs)	In	20kA	20kA	20kA
Max. discharge current (8/20μs)	Imax	40kA	40kA	40kA
Voltage protection level [(DC+/DC-)→PE]	Up	≤ 2.2kV	≤ 4.0kV	≤ 5.2kV
Leakage current	IPE(DC)	<0.02mA	<0.02mA	<0.02mA
Short circuit current	Iscpv	10kA	10kA	10kA
Response time	tA	≤ 25ns	≤ 25ns	≤ 25ns
Operating temperature range	Tu	-40°C -80°C	-40°C -80°C	-40°C -80°C
Operating state/fault indication		green/red	green/red	green/red
Cross-section area (Min.)		4mm <sup>2</sup>	4mm <sup>2</sup>	4mm <sup>2</sup>
Cross-section area (Max.)		35mm <sup>2</sup>	35mm <sup>2</sup>	35mm <sup>2</sup>
For mounting on		35mm Din rail	35mm Din rail	35mm Din rail
Enclosure material		Thermoplastic UL94-V0	Thermoplastic UL94-V0	Thermoplastic UL94-V0
Degree of protection		IP20	IP20	IP20
Order Code		B18009	B18010	B18018
Order code (With remote signal)		B18011	B18012	B18019

## BRPV2

### Type 2 DC Surge Arrester

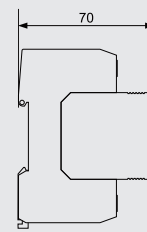
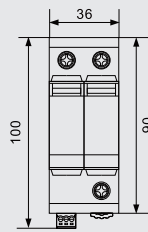
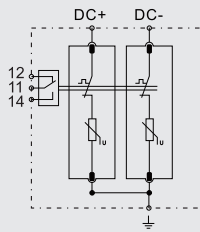

2 Mod		BRPV2-600
SPD classification according to EN61643-31/IEC61643-31		Type 2 / Class II
Max. continuous operating dc voltage	Ucpv	600V
Nominal discharge current (8/20μs)	In	20kA
Max. discharge current (8/20μs)	Imax	40kA
Voltage protection level	Up	≤ 2.2kV
Leakage current	IPE(DC)	<0.02mA
Short circuit current	Iscpv	10kA
Response time	tA	≤ 25ns
Operating temperature range	Tu	-40°C -80°C
Operating state/fault indication		green/red
Cross-section area (Min.)		4mm <sup>2</sup>
Cross-section area (Max.)		35mm <sup>2</sup>
For mounting on		35mm Din rail
Enclosure material		Thermoplastic UL94-V0
Degree of protection		IP20
Order Code		B18013
Order code (With remote signal)		B18015

## BR-40 DC

### Type 2 DC Surge Arrester

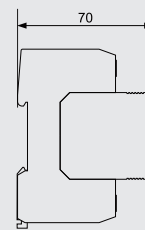
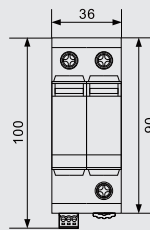
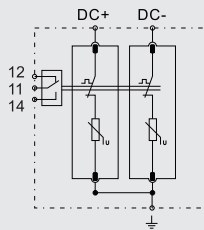
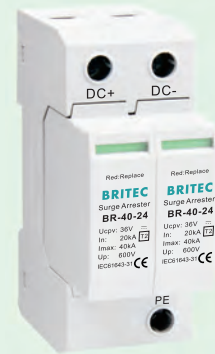

2 Mod		BR-40-24	BR-40-48	BR-40-75	BR-40-110
SPD classification according to EN61643-31		Type 2	Type 2	Type 2	Type 2
SPD classification according to IEC61643-31		Class II	Class II	Class II	Class II
Nominal voltage	Un	24V	48V	75V	110V
Max. continuous operating d.c. voltage	Ucpv	36V	65V	80V	180V
Nominal discharge current (8/20 μs)	In	20kA	20kA	20kA	20kA
Max. discharge current (8/20 μs)	Imax	40kA	40kA	40kA	40kA
Voltage protection level	Up	≤600V	≤700V	≤800V	≤900V
Leakage current	IPe(DC)	<0.02mA	<0.02mA	<0.02mA	<0.02mA
Short circuit current	Iscpv	10kA	10kA	10kA	10kA
Response time	tA	≤25ns	≤25ns	≤25ns	≤25ns
Operating temperature range	Tu	-40°C-80°C	-40°C-80°C	-40°C-80°C	-40°C-80°C
Operating state/fault indication		green/red	green/red	green/red	green/red
Cross-section area (Min.)		4 mm <sup>2</sup>	4 mm <sup>2</sup>	4 mm <sup>2</sup>	4 mm <sup>2</sup>
Cross-section area(Max.)		35mm <sup>2</sup>	35mm <sup>2</sup>	35mm <sup>2</sup>	35mm <sup>2</sup>
For mounting on		35mm Din rail	35mm Din rail	35mm Din rail	35mm Din rail
Enclosure material		Thermoplastic UL94-V0			
Degree of protection		IP20	IP20	IP20	IP20
Order Code		B18065	B18055	B18057	B18059
Order Code (With remote signaling)		B18066	B18056	B18058	B18060

## BRPV3GD

Type 2 DC Surge Arrester for PV

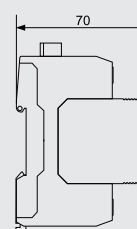
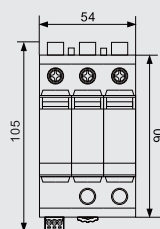
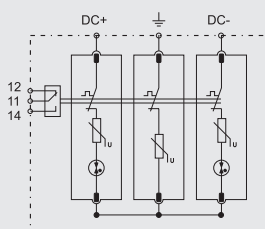

3 Mod free leakage current		BRPV3 600 GD	BRPV3 1000 GD
SPD classification according to EN61643-31/IEC61643-31		Type 2 / Class II	Type 2 / Class II
Max. continuous operating dc voltage	Ucpv	600V	1200V
Nominal discharge current (8/20μs)	In	20kA	20kA
Max. discharge current (8/20μs)	I <sub>max</sub>	40kA	40kA
Voltage protection level [(DC+/DC-)→PE]	Up	≤ 2.2kV	≤ 4.0kV
Leakage current	I <sub>PE(DC)</sub>	None	None
Short circuit current	I <sub>scpv</sub>	10kA	10kA
Response time	t <sub>A</sub>	≤ 100ns	≤ 100ns
Operating temperature range	T <sub>u</sub>	-40°C -80°C	-40°C -80°C
Operating state/fault indication		green/red	green/red
Cross-section area (Min.)		4mm <sup>2</sup>	4mm <sup>2</sup>
Cross-section area (Max.)		35mm <sup>2</sup>	35mm <sup>2</sup>
For mounting on		35mm Din rail	35mm Din rail
Enclosure material		Thermoplastic UL94-V0	Thermoplastic UL94-V0
Degree of protection		IP20	IP20
Order Code		B18005	B18006
Orde code (With remote signal)		B18007	B18008

## BRPV3-1000-20

Type 1+2 DC Surge Arrester for PV

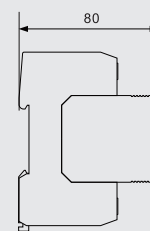
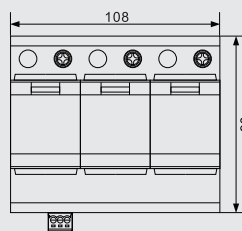
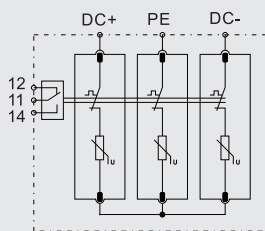
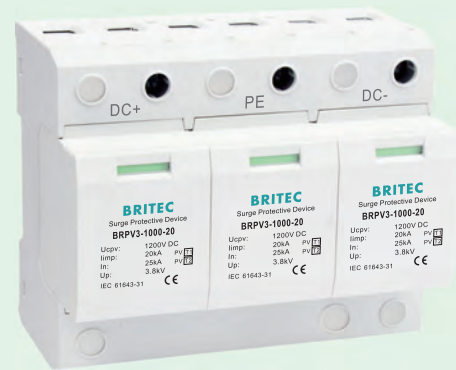

		BRPV3-1000-20
SPD classification according to EN61643-31/IEC61643-31		Type 1 + Type 2 / Class I + Class II
Max. continuous operating dc voltage	Ucpv	1200V
Lightning impulse current (10/350µs)	Iimp	20kA
Nominal discharge current (8/20µs)	In	25kA
Max. discharge current (8/20µs)	I <sub>max</sub>	80kA
Specific energy	W/R	100 kJ/Ω
Voltage protection level [(DC+/DC-)->PE]	Up	≤ 3.8kV
Leakage current	I <sub>PE(DC)</sub>	<0.02mA
Short circuit current	Iscpv	10kA
Response time	t <sub>A</sub>	≤ 25ns
Operating temperature range	T <sub>u</sub>	-40°C -80°C
Operating state/fault indication		green/red
Cross-section area (Min.)		4mm <sup>2</sup>
Cross-section area (Max.)		35mm <sup>2</sup>
For mounting on		35mm Din rail
Enclosure material		Thermoplastic UL94-V0
Degree of protection		IP20
Order Code		B18094
Order code (With remote signal)		B18095

## BRPV3-1500-12.5

Type 1+2 DC Surge Arrester for PV

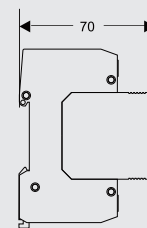
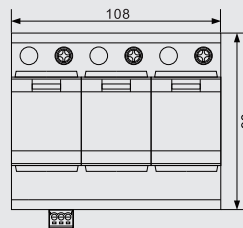
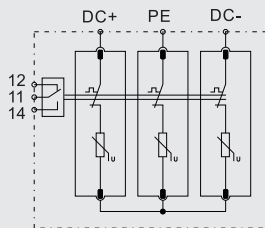
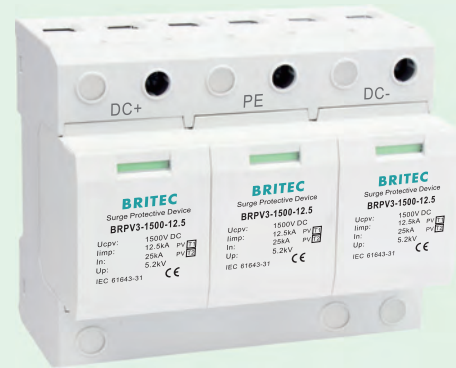

		BRPV3-1500-12.5
SPD classification according to EN61643-31/IEC61643-31		Type 1 + Type 2 / Class I + Class II
Max. continuous operating dc voltage	Ucpv	1500V
Lightning impulse current (10/350µs)	limp	12.5kA
Nominal discharge current (8/20µs)	In	25kA
Max. discharge current (8/20µs)	Imax	60kA
Specific energy	W/R	39kJ/Ω
Voltage protection level [(DC+/DC-)->PE]	Up	≤ 5.2kV
Leakage current	IPE(DC)	<0.02mA
Short circuit current	Iscpv	10kA
Response time	tA	≤ 25ns
Operating temperature range	Tu	-40°C -80°C
Operating state/fault indication		green/red
Cross-section area (Min.)		4mm <sup>2</sup>
Cross-section area (Max.)		35mm <sup>2</sup>
For mounting on		35mm Din rail
Enclosure material		Thermoplastic UL94-V0
Degree of protection		IP20
Order Code		B18092
Orde code (With remote signal)		B18093

## BRPV3 T1

Type 1+2 DC Surge Arrester for PV

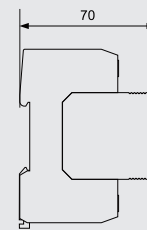
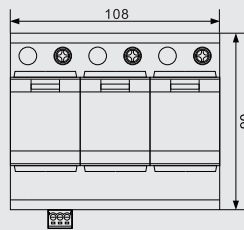
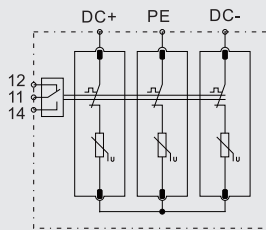

		BRPV3-600-12.5	BRPV3-1000-12.5
SPD classification according to EN61643-31/IEC61643-31		Type 1 + Type 2 / Class I + Class II	
Max. continuous operating dc voltage	Ucpv	600V	1200V
Lightning impulse current (10/350µs)	Iimp	12.5kA	12.5kA
Nominal discharge current (8/20µs)	In	25kA	25kA
Max. discharge current (8/20µs)	I <sub>max</sub>	60kA	60kA
Specific energy	W/R	39kJ/Ω	39kJ/Ω
Voltage protection level [(DC+/DC-)→PE]	Up	≤ 2.1kV	≤ 3.8kV
Leakage current	I <sub>PE(DC)</sub>	<0.02mA	<0.02mA
Short circuit current	I <sub>scpv</sub>	10kA	10kA
Response time	t <sub>A</sub>	≤ 25ns	≤ 25ns
Operating temperature range	T <sub>u</sub>	-40°C -80°C	-40°C -80°C
Operating state/fault indication		green/red	green/red
Cross-section area (Min.)		4mm <sup>2</sup>	4mm <sup>2</sup>
Cross-section area (Max.)		35mm <sup>2</sup>	35mm <sup>2</sup>
For mounting on		35mm Din rail	35mm Din rail
Enclosure material		Thermoplastic UL94-V0	
Degree of protection		IP20	IP20
Order Code		B18024	B18020
Order code (With remote signal)		B18025	B18021

## BRPV3 VG

Type 1+2 DC Surge Arrester for PV

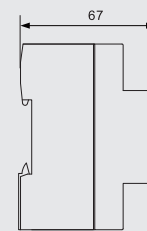
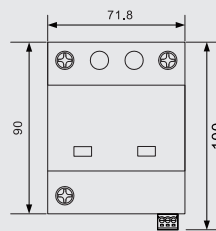
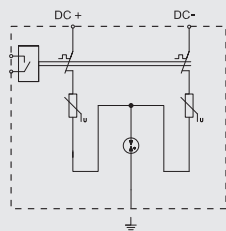

		BRPV3-600-12.5VG	BRPV3-1000-12.5VG
SPD classification according to EN61643-31/IEC61643-31		Type 1 + Type 2 / Class I + Class II	
Max. continuous operating dc voltage	Ucpv	600V	1000V
Lightning impulse current (10/350µs)	Iimp	12.5kA	12.5kA
Nominal discharge current (8/20µs)	In	25kA	25kA
Max. discharge current (8/20µs)	I <sub>max</sub>	60kA	60kA
Specific energy	W/R	39kJ/Ω	39kJ/Ω
Voltage protection level [(DC+/DC-)→PE]	Up	≤ 2.6kV	≤ 4.0kV
Leakage current	I <sub>PE(DC)</sub>	None	None
Short circuit current	I <sub>scpv</sub>	10kA	10kA
Response time	t <sub>A</sub>	≤ 100ns	≤ 100ns
Operating temperature range	T <sub>u</sub>	-40°C -80°C	-40°C -80°C
Operating state/fault indication		green/red	green/red
Cross-section area (Min.)		4mm <sup>2</sup>	4mm <sup>2</sup>
Cross-section area (Max.)		35mm <sup>2</sup>	35mm <sup>2</sup>
For mounting on		35mm Din rail	35mm Din rail
Enclosure material		Thermoplastic UL94-V0	
Degree of protection		IP20	IP20
Order Code		B18001	B18002
Order code (With remote signal)		B18003	B18004

## BRPV3 T1

### Type 1+2 DC Surge Arrester for PV

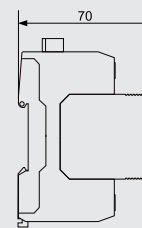
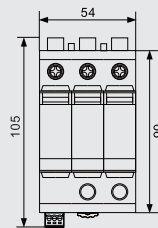
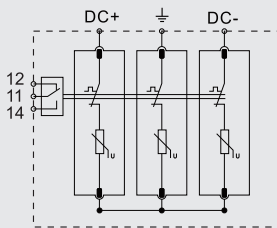
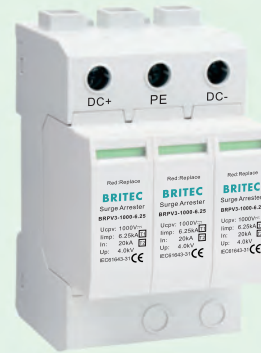

3 Mod		BRPV3-600-6.25	BRPV3-1000-6.25	BRPV3-1500-6.25
SPD classification according to EN61643-31/IEC61643-31		Type 1 + Type 2 / Class I + Class II		
Max. continuous operating dc voltage	Ucpv	600V	1000V	1500V
Lightning impulse current (10/350µs)	Iimp	6.25kA	6.25kA	6.25kA
Nominal discharge current (8/20µs)	In	20kA	20kA	20kA
Max. discharge current (8/20µs)	I <sub>max</sub>	40kA	40kA	40kA
Specific energy	W/R	9.76kJ/Ω	9.76kJ/Ω	9.76kJ/Ω
Voltage protection level [(DC+/DC-)->PE]	Up	≤ 2.2kV	≤ 4.0kV	≤ 5.2kV
Leakage current	I <sub>PE (DC)</sub>	<0.02mA	<0.02mA	<0.02mA
Short circuit current	I <sub>scpv</sub>	10kA	10kA	10kA
Response time	t <sub>A</sub>	≤ 25ns	≤ 25ns	≤ 25ns
Operating temperature range	T <sub>u</sub>	-40°C -80°C	-40°C -80°C	-40°C -80°C
Operating state/fault indication		green/red	green/red	green/red
Cross-section area (Min.)		4mm <sup>2</sup>	4mm <sup>2</sup>	4mm <sup>2</sup>
Cross-section area (Max.)		35mm <sup>2</sup>	35mm <sup>2</sup>	35mm <sup>2</sup>
For mounting on		35mm Din rail	35mm Din rail	35mm Din rail
Enclosure material		Thermoplastic UL94-V0	Thermoplastic UL94-V0	Thermoplastic UL94-V0
Degree of protection		IP20	IP20	IP20
Order Code		B18070	B18072	B18074
Orde code (With remote signal)		B18071	B18073	B18075

## BRPV2-600-6.25

Type 1+2 DC Surge Arrester for PV

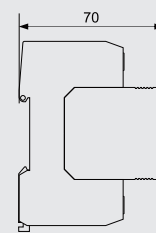
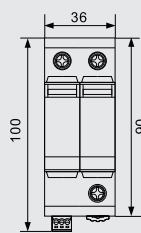
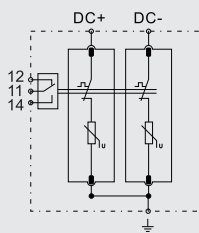
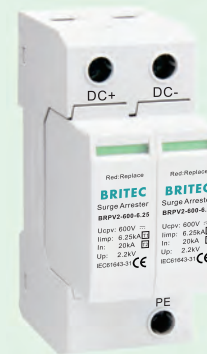

		BRPV2-600-6.25
SPD classification according to EN61643-31/IEC61643-31		Type 1 + Type 2 / Class I + Class II
Max. continuous operating dc voltage	Ucpv	600V
Lightning impulse current (10/350µs)	Iimp	6.25kA
Nominal discharge current (8/20µs)	In	20kA
Max. discharge current (8/20µs)	I <sub>max</sub>	40kA
Specific energy	W/R	9.76kJ/Ω
Voltage protection level [(DC+/DC-)->PE]	Up	≤ 2.2kV
Leakage current	I <sub>PE(DC)</sub>	<0.02mA
Short circuit current	I <sub>scpv</sub>	10kA
Response time	t <sub>A</sub>	≤ 25ns
Operating temperature range	T <sub>u</sub>	-40°C -80°C
Operating state/fault indication		green/red
Cross-section area (Min.)		4mm <sup>2</sup>
Cross-section area (Max.)		35mm <sup>2</sup>
For mounting on		35mm Din rail
Enclosure material		Thermoplastic UL94-V0
Degree of protection		IP20
Order Code		B18080
Order code (With remote signal)		B18081

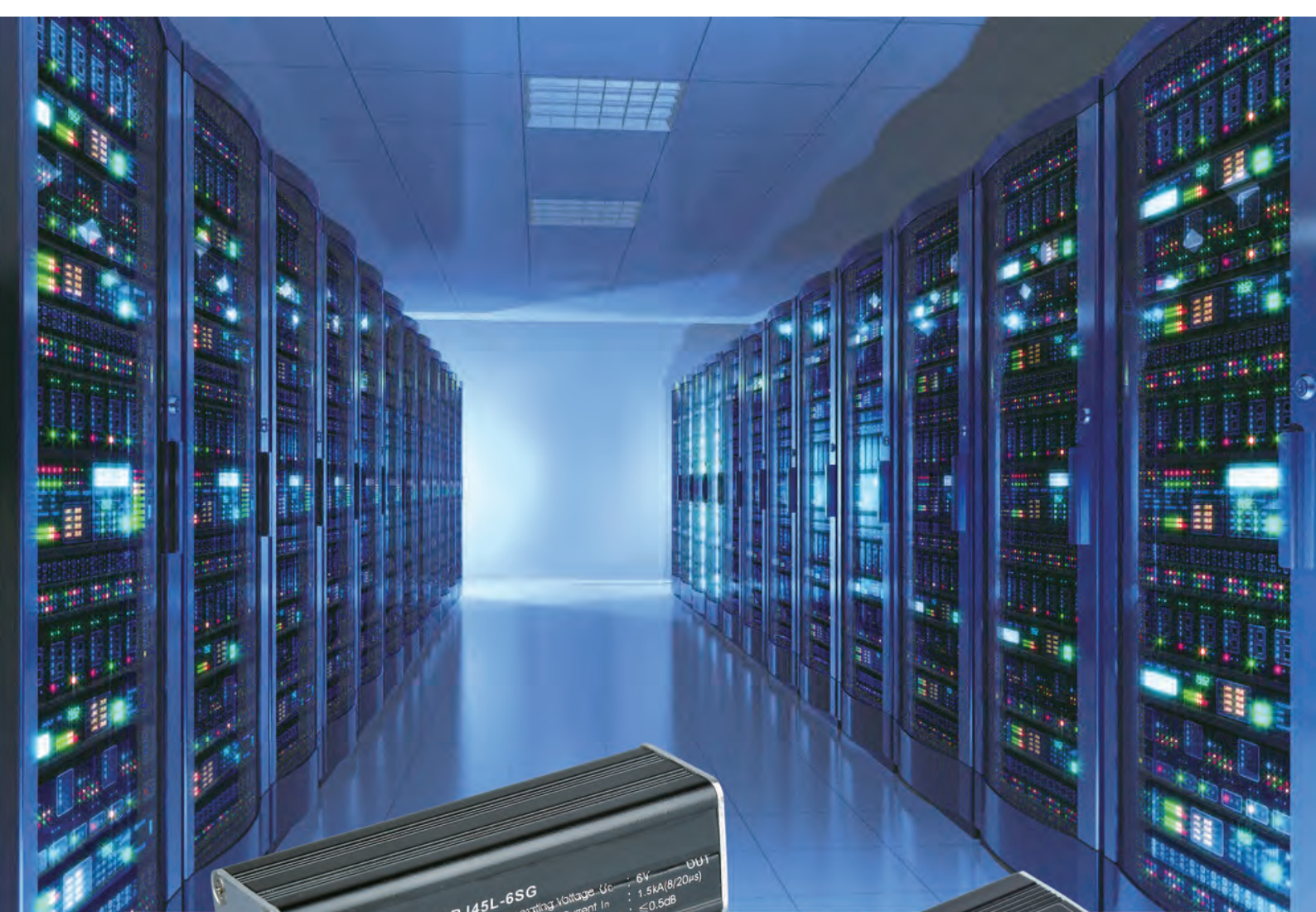

## SPD for Data Protection

## BRPI

SPDs for data

- Pluggable surge protection for DIN rail mounting
- All types of Telephone and Data lines
- Shield wire protection
- Without line cut-off (BRPI) or with (BRPIAO)
- IEC 61643-21 compliance

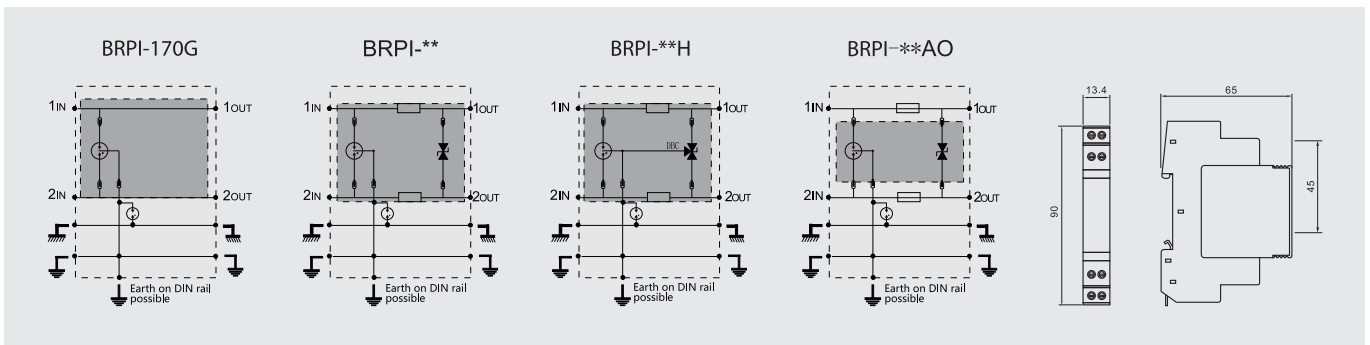

BRPI AO range: Line continuity in case of removal of plug-in module.

	BRPI-06	BRPI-12	BRPI-24	BRPI-48	BRPI-170	BRPI-06H	BRPI-48H	BRPI-170G	
Test standards	IEC 61643-21								
Nominal voltage	Un	6V	12V	24V	48V	150V	6V	48V	150V
Max. DC operating voltage	Uc	8V	15V	29V	56V	170V	8V	56V	170V
Max. AC operating voltage	Uc	5V	11V	20V	40V	130V	5V	40V	130V
Nominal current	IL	0.5A	0.5A	0.5A	0.5A	0.5A	0.5A	0.5A	0.5A
C2 Nominal discharge current(8/20µs) In		5kA	5kA	5kA	5kA	5kA	5kA	5kA	5kA
Voltage protection level [line-line] Up		≤30V	≤40V	≤60V	≤100V	≤320V	≤30V	≤100V	≤750V
Voltage protection level [line-PG] Up		≤600V	≤600V	≤600V	≤600V	≤600V	≤30V	≤100V	≤600V
Response time [line-line] tA		≤1ns	≤1ns	≤1ns	≤1ns	≤1ns	≤1ns	≤1ns	≤100ns
Response time [line-PG] tA		≤100ns	≤100ns	≤100ns	≤100ns	≤100ns	≤100ns	≤100ns	≤100ns
Operating temperature range TU	-40°C...+80°C								
Connection input/output	Terminal Block								
Bandwidth		3 Mbps	3 Mbps	3 Mbps	3 Mbps	10 Mbps	20 Mbps	20 Mbps	10 Mbps
Insertion Loss		≤0.3dB	≤0.3dB	≤0.3dB	≤0.3dB	≤0.3dB	≤0.3dB	≤0.3dB	≤0.3dB
Enclosure material	Thermoplastic UL94-V0								
Spare module	BRPIM-06D3	BRPIM-12D3	BRPIM-24D3	BRPIM-48D3	BRPIM-170	BRPIM-06H	BRPIM-48H	BRPIM-170G	
Network	RS 422	RS 232, RS 485	4-20mA	ISDN-T0, 48V line	Telephone line, ADSL2, VDSL	E1/T2 line 10BaseT	Fipway, WordFIP, FieldBus-h2	Telephone line, ADSL2, VDSL2, SHDSL	
Degree of protection	IP20								
BRPI range	D6015	D6011	D6009	D6007	D6003	D6013	D6005	D6000	
BRPI AO range	D6016	D6012	D6010	D6008	D6004	D6014	D6006	—	



## SPDs for general information(plug-in) BR BD 4L

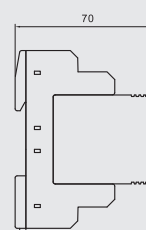
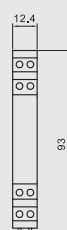
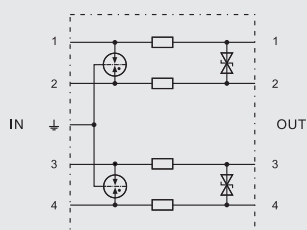

		BR BD 4L-6	BR BD 4L-12	BR BD 4L-24	BR BD 4L-48	BR BD 4L-60	BR BD 4L-180
Test standards		IEC 61643-21	IEC 61643-21	IEC 61643-21	IEC 61643-21	IEC 61643-21	IEC 61643-21
SPD class		TYPE2 P1	TYPE2 P1	TYPE2 P1	TYPE2 P1	TYPE2 P1	TYPE2 P1
Nominal voltage	Un	5V	12V	24V	48V	60V	180V
Max. continuous operating d.c. voltage	Uc	6.0V	15V	33V	54V	70V	180V
Max. continuous operating a.c. voltage	Uc	4.2V	10.6V	23.3V	38.1V	49.5V	127V
Nominal current at 45°C	IL	1A	1A	1A	1A	1A	0.75A
C2 Total nominal discharge current (8/20µs)	In	20kA	20kA	20kA	20kA	20kA	20kA
C2 Nominal discharge current (8/20µs) per line	In	10kA	10kA	10kA	10kA	10kA	10kA
Voltage protection level line–line for In C2	Up	≤15V	≤27V	≤55V	≤85V	≤110V	≤270V
Voltage protection level line–PG for In C2	Up	≤600V	≤600V	≤600V	≤600V	≤600V	≤600V
Voltage protection level line–line at 1 kV/µs C3	Up	≤9V	≤19V	≤45V	≤70V	≤90V	≤250V
Voltage protection level line–PG at 1 kV/µs C3	Up	≤550V	≤550V	≤550V	≤550V	≤550V	≤550V
Series impedance per line		1 Ohm	1 Ohm	1 Ohm	1 Ohm	1 Ohm	1.8 Ohm
Cut-off frequency line–PG	fG	1.0 MHz	2.8 MHz	7.8 MHz	8.7 MHz	11.0 MHz	25.0 MHz
Capacitance line–line	C	≤5.4 nF	≤2.0 nF	≤1.0 nF	≤0.7nF	≤500pF	≤240pF
capacitance line–PG	C	≤16 pF	≤16 pF	≤16 pF	≤16 pF	≤16 pF	≤16 pF
Operating temperature range	Tu	–40°C...+80°C	–40°C...+80°C	–40°C...+80°C	–40°C...+80°C	–40°C...+80°C	–40°C...+80°C
Enclosure material		polyamide PA 6.6					
Degree of protection (plugged-in)		IP 20	IP 20	IP 20	IP 20	IP 20	IP 20
Order Code		D9110	D9111	D9112	D9113	D9114	D9115



## SPDs for general information (plug-in)

### BR BE 4L

High degree of protection for four single lines

For installation in conformity with the lightning protection zone concept at the boundaries from 0B-2 and higher

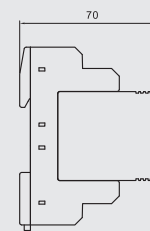
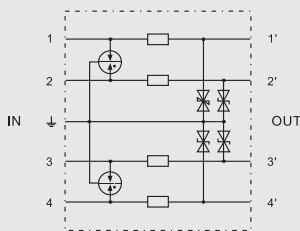

		BR BE 4L-6	BR BE 4L-12	BR BE 4L-24	BR BE 4L-48	BR BE 4L-60	BR BE 4L-180
Test standards		IEC 61643-21	IEC 61643-21	IEC 61643-21	IEC 61643-21	IEC 61643-21	IEC 61643-21
SPD class		TYPE2 P1	TYPE2 P1	TYPE2 P1	TYPE2 P1	TYPE2 P1	TYPE2 P1
Nominal voltage	Un	5V	12V	24V	48V	60V	180V
Max. continuous operating d.c. voltage	Uc	6.0V	15V	33V	54V	70V	180V
Max. continuous operating a.c. voltage	Uc	4.2V	10.6V	23.3V	38.1V	49.5V	127V
Nominal current at 45°C	IL	1A	0.75A	0.75A	0.75A	1A	1A
C2 Total nominal discharge current (8/20µs)	In	20kA	20kA	20kA	20kA	20kA	20kA
C2 Nominal discharge current (8/20µs) per line	In	10kA	10kA	10kA	10kA	10kA	10kA
Voltage protection level line–line for In C2	Up	≤40V	≤55V	≤105V	≤170V	≤220V	≤550V
Voltage protection level line–PG for In C2	Up	≤60V	≤60V	≤85V	≤115V	≤155V	≤300V
Voltage protection level line–line at 1 kV/µs C3	Up	≤18V	≤38V	≤90V	≤140V	≤180V	≤500V
Voltage protection level line–PG at 1 kV/µs C3	Up	≤9V	≤19V	≤45V	≤70V	≤90V	≤250V
Series impedance per line		1 Ohm	1.8 Ohm	1.8 Ohm	1.8 Ohm	1 Ohm	1 Ohm
Cut-off frequency line–PG	fG	1.0 MHz	2.7 MHz	6.8 MHz	8.7 MHz	9.0 MHz	25.0 MHz
Capacitance line–line	C	≤2.7 nF	≤1.0 nF	≤0.5 nF	≤0.35 nF	≤250 pF	≤120 pF
capacitance line–PG	C	≤5.4 nF	≤2.0 nF	≤1.0 nF	≤0.7 nF	≤500 pF	≤240 pF
Operating temperature range	Tu	–40°C...+80°C	–40°C...+80°C	–40°C...+80°C	–40°C...+80°C	–40°C...+80°C	–40°C...+80°C
Enclosure material		polyamide PA 6.6					
Degree of protection (plugged-in)		IP 20	IP 20	IP 20	IP 20	IP 20	IP 20
Order Code		D9116	D9117	D9118	D9119	D9120	D9121

## SPDs for general BR-ME

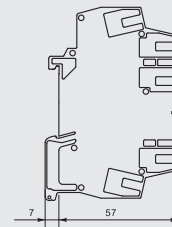
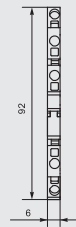
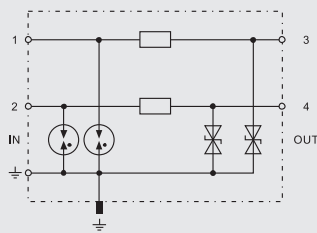

		BR-ME-12	BR-ME-24	BR-ME-48	BR-ME-110
Test standards		IEC 61643-21	IEC 61643-21	IEC 61643-21	IEC 61643-21
SPD class		TYPE2 P1	TYPE2 P1	TYPE2 P1	TYPE2 P1
Nominal voltage	U <sub>n</sub>	12V	24V	48V	110V
Max. continuous operating d.c. voltage	U <sub>c</sub>	14V	33V	55V	170V
Max. continuous operating a.c. voltage	U <sub>c</sub>	9.5V	23V	38.5V	120V
Nominal current at 45°C	I <sub>L</sub>	0.5A	0.5A	0.5A	0.5A
C2 Total nominal discharge current (8/20µs)	I <sub>n</sub>	10kA	10kA	10kA	10kA
C2 Nominal discharge current (8/20µs) per line	I <sub>n</sub>	5kA	5kA	5kA	5kA
Voltage protection level line–line for I <sub>n</sub> C2	U <sub>p</sub>	≤55V	≤110V	≤175V	≤500V
Voltage protection level line–PG for I <sub>n</sub> C2	U <sub>p</sub>	≤40V	≤65V	≤100V	≤270V
Voltage protection level line–line at 1 kV/µs C3	U <sub>p</sub>	≤36V	≤90V	≤160V	≤460V
Voltage protection level line–PG at 1 kV/µs C3	U <sub>p</sub>	≤19V	≤45V	≤80V	≤230V
Series impedance per line		1.8 Ohm	1.8 Ohm	1.8 Ohm	1.8 Ohm
Cut-off frequency line–PG	f <sub>G</sub>	2.5 MHz	6 MHz	10 MHz	16 MHz
Capacitance line–line	C	< 1.2 nF	< 0.5 nF	< 0.3 nF	< 0.2 nF
capacitance line–PG	C	< 2.4 nF	< 1.0 nF	< 0.6 nF	< 0.4 nF
Operating temperature range	T <sub>u</sub>	–40°C...+80°C	–40°C...+80°C	–40°C...+80°C	–40°C...+80°C
Cross section of cable		0.08–2.5mm <sup>2</sup>	0.08–2.5mm <sup>2</sup>	0.08–2.5mm <sup>2</sup>	0.08–2.5mm <sup>2</sup>
Enclosure material		polyamide PA 6.6			
Degree of protection (plugged-in)		IP 20	IP 20	IP 20	IP 20
Order Code		D9131	D9132	D9133	D9134

## SPDs for general BR-MD

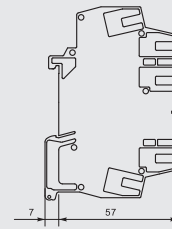
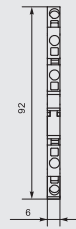
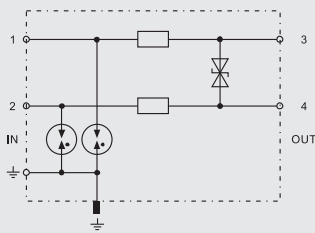

		BR-MD-12	BR-MD-24	BR-MD-48	BR-MD-110
Test standards		IEC 61643-21	IEC 61643-21	IEC 61643-21	IEC 61643-21
SPD class		TYPE2 P1	TYPE2 P1	TYPE2 P1	TYPE2 P1
Nominal voltage	Un	12V	24V	48V	110V
Max. continuous operating d.c. voltage	Uc	14V	33V	55V	170V
Max. continuous operating a.c. voltage	Uc	9.5V	23V	38.5V	120V
Nominal current at 45°C	IL	0.5A	0.5A	1.7A	0.5A
C2 Total nominal discharge current (8/20µs)	In	10kA	10kA	10kA	10kA
C2 Nominal discharge current (8/20µs) per line	In	5kA	5kA	5kA	5kA
Voltage protection level line–line for In C2	Up	≤25V	≤50V	≤100V	≤260V
Voltage protection level line–PG for In C2	Up	≤750V	≤750V	≤750V	≤750V
Voltage protection level line–line at 1 kV/µs C3	Up	≤19V	≤45V	≤70V	≤230V
Voltage protection level line–PG at 1 kV/µs C3	Up	≤650V	≤650V	≤650V	≤650V
Series impedance per line		1.8 Ohm	1.8 Ohm	1.8 Ohm	1.8 Ohm
Cut-off frequency line–PG	fG	2.5 MHz	6 MHz	10 MHz	16 MHz
Capacitance line–line	C	≤2.4 nF	≤1 nF	< 0.6 nF	< 0.4 nF
capacitance line–PG	C	≤5 pF	≤5 pF	< 10 pF	< 5 pF
Operating temperature range	Tu	–40°C...+80°C	–40°C...+80°C	–40°C...+80°C	–40°C...+80°C
Cross section of cable		0.08–2.5mm <sup>2</sup>	0.08–2.5mm <sup>2</sup>	0.08–2.5mm <sup>2</sup>	0.08–2.5mm <sup>2</sup>
Enclosure material		polyamide PA 6.6			
Degree of protection (plugged-in)		IP 20	IP 20	IP 20	IP 20
Order Code		D9151	D9152	D9153	D9154

## SPD for POE BR-POE

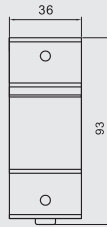
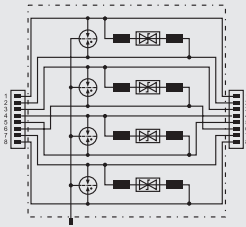

BR-POE-P

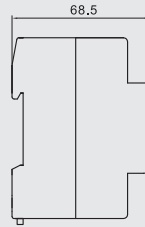

BR-POE-M

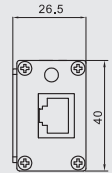
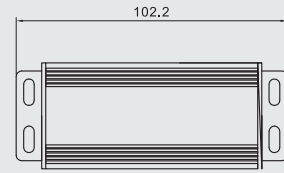

		BR-POE-P	BR-POE-M
Test standards		IEC 61643-21	IEC 61643-21
SPD class		TYPE2 P1	TYPE2 P1
Nominal voltage	Un	48V	48V
Max. continuous operating d.c. voltage	Uc	48V	48V
Max. continuous operating a.c. voltage	Uc	34V	34V
Max. continuous operating d.c. voltage pair-pair(PoE)	Uc	57V	57V
Nominal current	IL	1A	1A
D1 Lightning impulse current (10/350 μs) per line	Iimp	0.5kA	0.5kA
C2 Nominal discharge current (8/20μs) line-line	In	150A	150A
C2 Nominal discharge current (8/20μs) line-PG	In	3kA	3kA
C2 Total nominal discharge current (8/20μs) line-PG	In	10kA	10kA
C2 Nominal discharge current (8/20μs) pair-pair(PoE)	In	150A	150A
Voltage protection level pair-pair for In C2	Up	≤ 180V	≤ 180V
Voltage protection level line-PG for In C2	Up	≤ 500V	≤ 500V
Voltage protection level line-line for In C2(PoE)	Up	≤ 600V	≤ 600V
Insertion loss at 250 MHz		≤ 3 dB	≤ 3 dB
Capacitance line-line	C	≤ 30 pF	≤ 30 pF
capacitance line-PG	C	≤ 25 pF	≤ 25 pF
Operating temperature range	Tu	-40°C...+80°C	-40°C...+80°C
For mounting on		35mm DIN rails acc. to EN 60715	35mm DIN rails acc. to EN 60715
Connection (input/output)		RJ45 socket/RJ45 socket	RJ45 socket/RJ45 socket
Pinning		1/2, 3/6, 4/5, 7/8	1/2, 3/6, 4/5, 7/8
Earthing via		35mm DIN rails acc. to EN 60715	35mm DIN rails acc. to EN 60715
Enclosure material		polyamide PA 6.6	aluminium alloy
Degree of protection (plugged-in)		IP20	IP20
Order Code		D9161	D9160



## SPDs for general information BRGI-2L

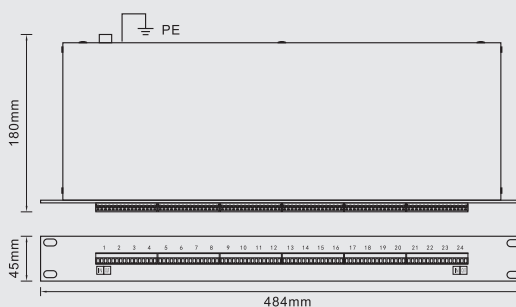
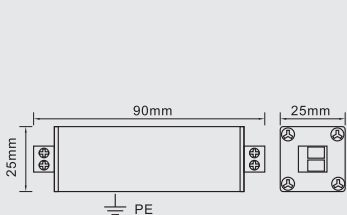
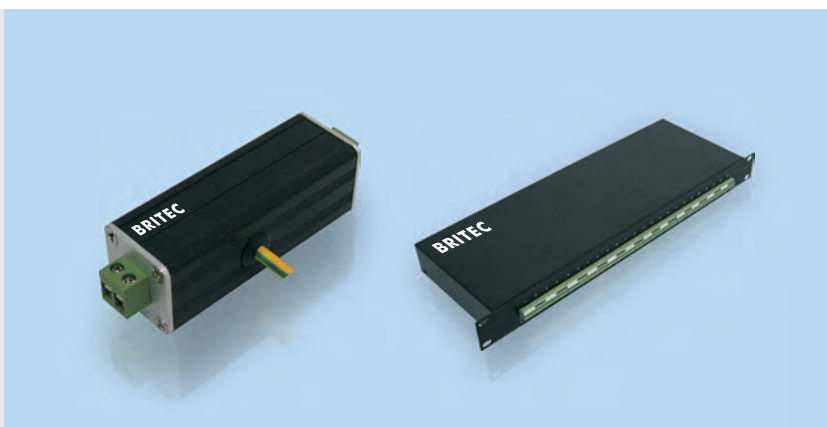

		BRGI-2L-6	BRGI-2L-12	BRGI-2L-24	BRGI-2L-48	BRGI-2L-60	BRGI-2L-180
Test standards		IEC 61643-21	IEC 61643-21	IEC 61643-21	IEC 61643-21	IEC 61643-21	IEC 61643-21
Nominal voltage	Un	6V	12V	24V	48V	60V	180V
Max. continuous operating d.c. voltage	Uc	8V	15V	29V	56V	70V	180V
Max. continuous operating a.c. voltage	Uc	5V	11V	20V	40V	49V	130V
Nominal current	IL	0.5A	0.5A	0.5A	0.5A	0.5A	0.5A
C2 Nominal discharge current(8/20µs) per line	In	5kA	5kA	5kA	5kA	5kA	5kA
Voltage protection level [line–line]	Up	≤30V	≤40V	≤60V	≤100V	≤130V	≤320V
Voltage protection level [line–PG]	Up	≤600V	≤600V	≤600V	≤600V	≤600V	≤600V
Response time [line–line]	tA	≤1ns	≤1ns	≤1ns	≤1ns	≤1ns	≤1ns
Response time [line–PG]	tA	≤100ns	≤100ns	≤100ns	≤100ns	≤100ns	≤100ns
Operating temperature range	TU	–40°C...+80°C	–40°C...+80°C	–40°C...+80°C	–40°C...+80°C	–40°C...+80°C	–40°C...+80°C
Connection input/output		Terminal Block	Terminal Block	Terminal Block	Terminal Block	Terminal Block	Terminal Block
Bandwidth		10 Mbps	10 Mbps	10 Mbps	10 Mbps	10 Mbps	10 Mbps
Insertion Loss		≤0.3dB	≤0.3dB	≤0.3dB	≤0.3dB	≤0.3dB	≤0.3dB
Enclosure material		aluminium alloy					
Degree of protection		IP20	IP20	IP20	IP20	IP20	IP20
Order Code 1port		D9001	D9002	D9003	D9004	D9005	D9006
Order Code 24ports		D9007	D9008	D9009	D9010	D9011	D9012

## SPDs for RJ BR-RJ45/RJ11

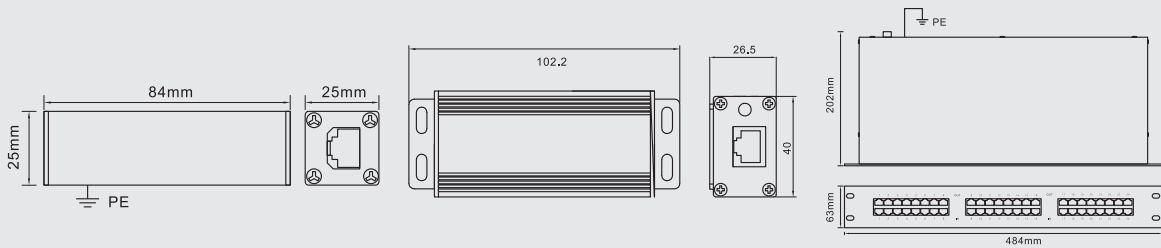

		BRRJ45L-4L	BRRJ45H-8L	BRRJ45L-4LR	BRRJ11L-2L	BRRJ11H-4L
Test standards		IEC 61643-21	IEC 61643-21	IEC 61643-21	IEC 61643-21	IEC 61643-21
Nominal voltage	Un	5V	5V	5V	110V	110V
Max. continuous operating d.c. voltage	Uc	6V	6V	6V	170V	170V
Max. continuous operating a.c. voltage	Uc	4V	4V	4V	120V	120V
Nominal current	IL	0.5A	0.5A	0.5A	0.5A	0.5A
D1 Lightning impulse current (10/350 μs) per line	Iimp	0.5 kA	0.5 kA	0.5 kA	—	—
C2 Nominal discharge current(8/20μs) per line	In	1.5kA	1.5kA	1.5kA	1.5kA	1.5kA
Voltage protection level [line–line] @200A	Up	≤30V	≤30V	≤30V	≤250V	≤250V
Voltage protection level [line–PG] @1.5kA	Up	≤500V	≤500V	≤500V	≤600V	≤600V
Voltage protection level line–line at 1 kV/μs C3	Up	≤180V	≤180V	≤180V	—	—
Voltage protection level line–PG at 1 kV/μs C3	Up	≤500V	≤500V	≤500V	—	—
Response time [line–line]	tA	≤1ns	≤1ns	≤1ns	≤1ns	≤1ns
Response time [line–PG]	tA	≤100ns	≤100ns	≤100ns	≤100ns	≤100ns
Operating temperature range	TU	–40°C...+80°C	–40°C...+80°C	–40°C...+80°C	–40°C...+80°C	–40°C...+80°C
Connection input/output		RJ45 socket 4 line	RJ45 socket 8 line	RJ45 24 sockets	RJ11 socket 2 line	RJ11 socket 4 line
Bandwidth		30 Mbps	300 Mbps	30 Mbps	10 Mbps	30 Mbps
Insertion Loss		≤0.3dB	≤0.3dB	≤0.3dB	≤0.3dB	≤0.3dB
Enclosure material		aluminium alloy				
Degree of protection		IP20	IP20	IP20	IP20	IP20
Order Code		D9030	D9031	D9032	D9033	D9034

## SPDs for Coaxial

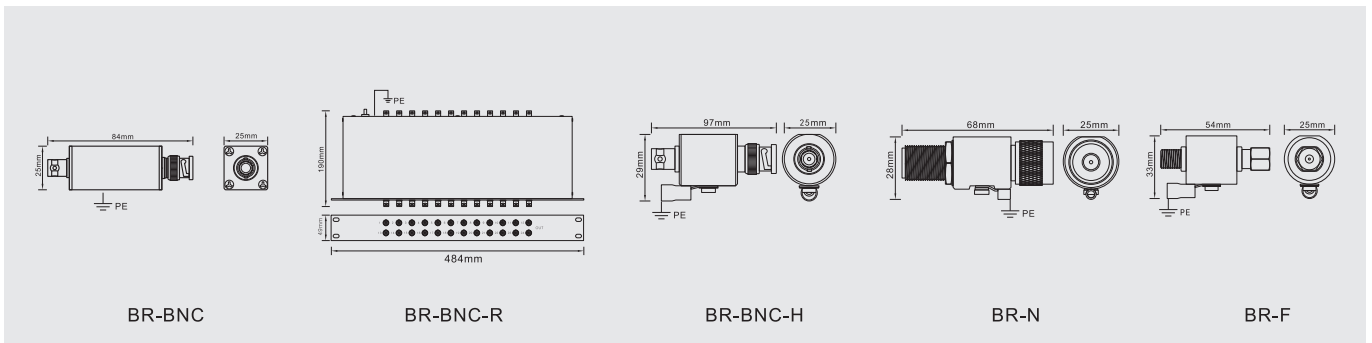

		BR-BNC	BR-BNC-R	BR-BNC-H	BR-N	BR-F
Test standards		IEC 61643-21	IEC 61643-21	IEC 61643-21	IEC 61643-21	IEC 61643-21
Nominal voltage	Un	5V	5V	–	–	–
Max. continuous operating d.c. voltage	Uc	6V	6V	180V	180V	180V
Max. continuous operating a.c. voltage	Uc	4V	4V	130V	130V	130V
Nominal current IL	IL	0.5A	0.5A	20A	20A	20A
C2 Nominal discharge current(8/20µs) line–shield	In	5kA	5kA	–	–	–
C2 Nominal discharge current(8/20µs) shield–PG	In	10kA	10kA	–	–	–
C2 Nominal discharge current(8/20µs) line–shield/PG	In	–	–	10kA	10kA	10kA
Voltage protection level [line–shield]	Up	≤30V	≤30V	–	–	–
Voltage protection level [shield–PG]	Up	≤500V	≤500V	–	–	–
Voltage protection level [line–shield/PG]	Up	–	–	≤800V	≤800V	≤800V
Response time [line–shield]	tA	≤1ns	≤1ns	–	–	–
Response time [shield–PG]	tA	≤100ns	≤100ns	–	–	–
Response time [line–shield/PG]	tA	–	–	≤100ns	≤100ns	≤100ns
Operating temperature range	TU	–40°C...+80°C	–40°C...+80°C	–40°C...+80°C	–40°C...+80°C	–40°C...+80°C
Connection input/output		BNC socket	BNC 24 sockets	BNC socket	N socket	F socket
Bandwidth		10 Mbps	10 Mbps	3 Gbps	3 Gbps	3 Gbps
Insertion Loss		≤0.3dB	≤0.3dB	≤0.3dB	≤0.3dB	≤0.3dB
Impedance		50 Ω	50 Ω	50 Ω	50 Ω	50 Ω
Enclosure material		aluminium alloy	aluminium alloy	Steel	Steel	Steel
Degree of protection		IP20	IP20	IP20	IP20	IP20
Order Code		D9020	D9021	D9022	D9023	D9024

## SPDs for D-Sub BR-DB

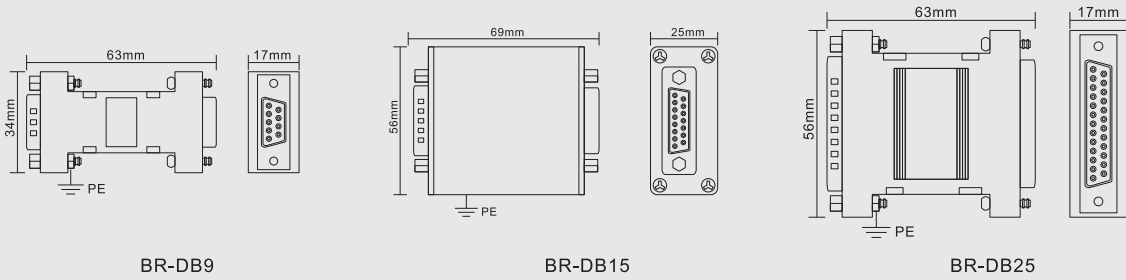
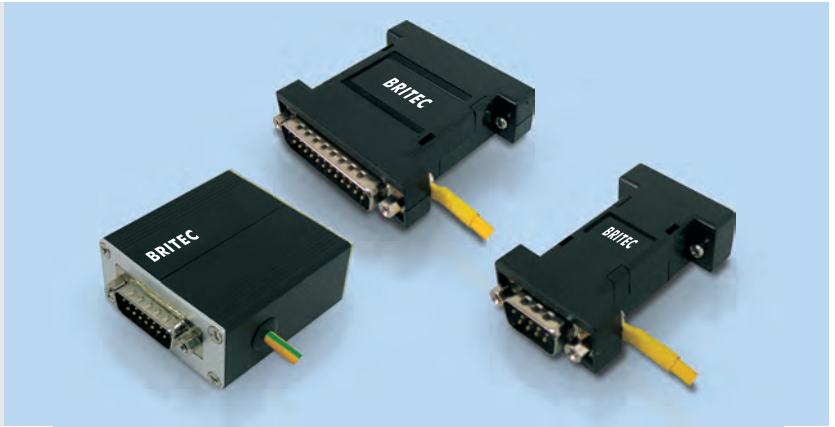

BR-DB9

BR-DB15

BR-DB25

		BR-DB9	BR-DB15	BR-DB25
Test standards		IEC 61643-21	IEC 61643-21	IEC 61643-21
Nominal voltage	Un	12V	12V	12V
Max. continuous operating d.c. voltage	Uc	15V	15V	15V
C2 Nominal discharge current(8/20µs) line-SG	In	5kA	5kA	5kA
C2 Nominal discharge current(8/20µs) SG-PG	In	10kA	10kA	10kA
Voltage protection level [line-SG]	Up	≤40V	≤40V	≤40V
Voltage protection level [SG-PG]	Up	≤500V	≤500V	≤500V
Response time [line-SG]	tA	≤1ns	≤1ns	≤1ns
Response time [SG-PG]	tA	≤100ns	≤100ns	≤100ns
Operating temperature range	TU	-40°C...+80°C	-40°C...+80°C	-40°C...+80°C
Connection input/output		D-Sub 9 plug/socket	D-Sub 15 plug/socket	D-Sub 25 plug/socket
Pinning		line:3/8, SG:5, PG:1	line:2/9,4/11, SG:8, PG:1	line:2/3/4/5/6/8/20, SG:7
Bandwidth		10 Mbps	10 Mbps	10 Mbps
Insertion Loss		≤0.3dB	≤0.3dB	≤0.3dB
Enclosure material		aluminium alloy		
Degree of protection		IP20	IP20	IP20
Order Code		D9070	D9071	D9072

## SPDs for CCTV CCTV-21

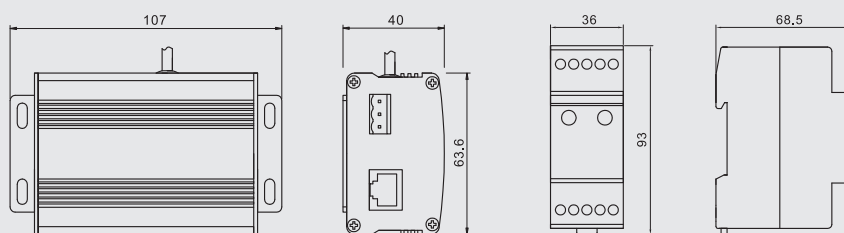
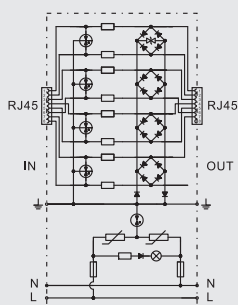

		CCTV-21M-48	CCTV-21M-230	CCTV-21P-48	CCTV-21P-230
Test standards		IEC 61643-21	IEC 61643-21	IEC 61643-21	IEC 61643-21
Max. continuous operating d.c. voltage	$(RJ45)U_c$	8V	8V	8V	8V
Max. continuous operating a.c. voltage	$(RJ45)U_c$	5.5V	5.5V	5.5V	5.5V
Max. continuous operating a.c. voltage	$(power)U_c$	60V	275V	60V	275V
Nominal current	IL	1A	1A	1A	1A
C2 Nominal discharge current(8/20 $\mu$ s)	In	3kA	3kA	3kA	3kA
C2 Max. discharge current(8/20 $\mu$ s)	I <sub>max</sub>	10kA	10kA	10kA	10kA
Voltage protection level [line-line]	$(RJ45)U_p$	$\leq 30V$	$\leq 30V$	$\leq 30V$	$\leq 30V$
Voltage protection level [line-PG]	$(RJ45)U_p$	$\leq 500V$	$\leq 500V$	$\leq 500V$	$\leq 500V$
Voltage protection level	$(power)U_p$	$\leq 200V$	$\leq 1.2kV$	$\leq 200V$	$\leq 1.2kV$
Response time [line-line]	t <sub>A</sub>	$\leq 1ns$	$\leq 1ns$	$\leq 1ns$	$\leq 1ns$
Response time [line-PG]	t <sub>A</sub>	$\leq 100ns$	$\leq 100ns$	$\leq 100ns$	$\leq 100ns$
Operating temperature range	TU	-40°C...+80°C	-40°C...+80°C	-40°C...+80°C	-40°C...+80°C
Connection input/output	RJ45/Power	RJ45/Terminal block	RJ45/Terminal block	RJ45/Terminal block	RJ45/Terminal block
Bandwidth		30 Mbps	30 Mbps	30 Mbps	30 Mbps
Insertion Loss		$\leq 0.3dB$	$\leq 0.3dB$	$\leq 0.3dB$	$\leq 0.3dB$
Enclosure material		aluminium alloy	aluminium alloy	Thermoplastic	Thermoplastic
Degree of protection		IP20	IP20	IP20	IP20
Order Code		D9050	D9051	D9052	D9053

## BRCB-15/30/40 TP

Type 2 Surge Arrester  
Combined with Mini Circuit Breaker

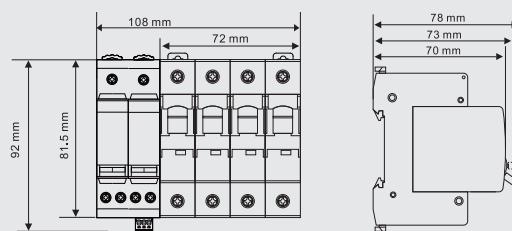
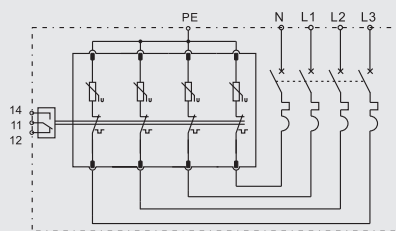
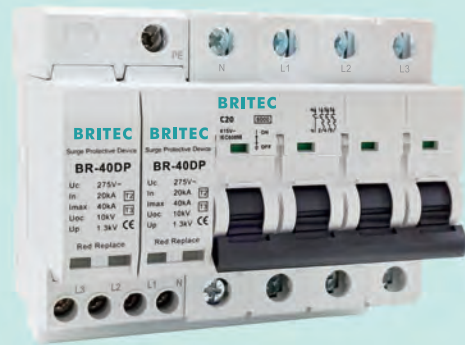

■ BRCB combined surge arrester can provide surge protection for TN-S system.

		BRCB-15 TP	BRCB-30 TP	BRCB-40 TP
SPD classification according to EN61643-11		Type 2	Type 2	Type 2
SPD classification according to IEC61643-11		Class II	Class II	Class II
Nominal a.c. voltage	Un	230V	230V	230V
Max. continuous operating a.c. voltage	Uc	275V	275V	275V
Mcb rated current		16A	20A	32A
Nominal discharge current (8/20μs)	In	5kA	15kA	20kA
Max. discharge current (8/20μs)	Imax	15kA	30kA	40kA
voltage protection level	Up	≤ 1.1kV	≤ 1.3kV	≤ 1.3kV
Response time	tA	≤ 25ns	≤ 25ns	≤ 25ns
Operating temperature range	Tu	-40°C-80°C	-40°C-80°C	-40°C-80°C
Operating state/fault indication		green/red	green/red	green/red
Cross-section area (Min.)		2.5mm <sup>2</sup>	2.5mm <sup>2</sup>	2.5mm <sup>2</sup>
Cross-section area (Max.)		15mm <sup>2</sup>	15mm <sup>2</sup>	15mm <sup>2</sup>
For mounting on		35mm Din rail	35mm Din rail	35mm Din rail
Enclosure material		Thermoplastic UL-94V0		
Degree of protection		IP20	IP20	IP20
Order Code		B7914	B7916	B7918
Order Code(with remote signal)		B7915	B7917	B7919

## BRCB-15/30/40

Type 2 Surge Arrester  
Combined with Mini Circuit Breaker

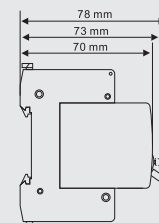
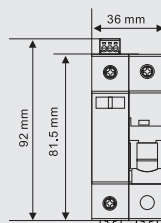
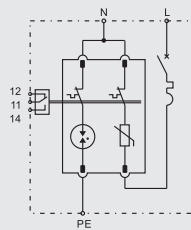

■ BRCB combined surge arrester can provide surge protection for TN system.

		BRCB-15	BRCB-30	BRCB-40
SPD classification according to EN61643-11		Type 2	Type 2	Type 2
SPD classification according to IEC61643-11		Class II	Class II	Class II
Nominal a.c. voltage	Un	230V	230V	230V
Max. continuous operating a.c. voltage	Uc	275V	275V	275V
Mcb rated current		16A	20A	32A
Nominal discharge current (8/20μs)	In	5kA	15kA	20kA
Max. discharge current (8/20μs)	I <sub>max</sub>	15kA	30kA	40kA
Voltage protection level	Up	≤ 1.1kV	≤ 1.3kV	≤ 1.3kV
Response time	t <sub>A</sub>	≤ 25ns	≤ 25ns	≤ 25ns
Operating temperature range	Tu	-40°C-80°C	-40°C-80°C	-40°C-80°C
Operating state/fault indication		green/red	green/red	green/red
Cross-section area (Min.)		2.5mm <sup>2</sup>	2.5mm <sup>2</sup>	2.5mm <sup>2</sup>
Cross-section area (Max.)		15mm <sup>2</sup>	15mm <sup>2</sup>	15mm <sup>2</sup>
For mounting on		35mm Din rail	35mm Din rail	35mm Din rail
Enclosure material		Thermoplastic UL-94V0		
Degree of protection		IP20	IP20	IP20
Order Code		B8460	B8462	B8464
Order Code(with remote signal)		B8461	B8463	B8465

## BRSCB-I-25

### MCB for Surge Arrester

MCB specially designed for Surge Arrester It can cut the leakage current to 3A.

Therefore prevent possible fire hazzard caused by degenerated SPD.

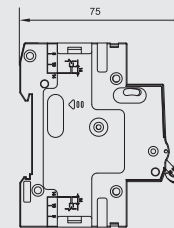
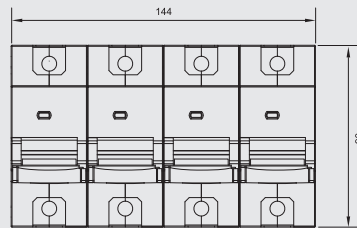
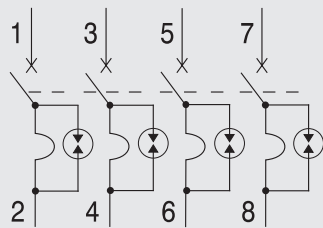

■ Special MCB designed to protect the SPD.

		BRSCB-I-25-4P	BRSCB-I-25-3P	BRSCB-I-25-2P	BRSCB-I-25-1P
Nominal a.c. voltage	Un	500V	500V	500V	500V
Impluse current (10/350µs)	Iimp	25kA	25kA	25kA	25kA
Nominal discharge current (8/20µs)	In	50kA	50kA	50kA	50kA
Max. discharge current (8/20µs)	I <sub>max</sub>	100kA	100kA	100kA	100kA
Operating temperature range	Tu	-40°C-80°C	-40°C-80°C	-40°C-80°C	-40°C-80°C
Operating state/fault indication		green/red	green/red	green/red	green/red
Cross-section area (Min.)		2.5mm <sup>2</sup>	2.5mm <sup>2</sup>	2.5mm <sup>2</sup>	2.5mm <sup>2</sup>
Cross-section area (Max.)		35mm <sup>2</sup>	35mm <sup>2</sup>	35mm <sup>2</sup>	35mm <sup>2</sup>
For mounting on		35mm Din rail	35mm Din rail	35mm Din rail	35mm Din rail
Enclosure material		Thermoplastic UL94-V0			
Degree of protection		IP20	IP20	IP20	IP20
Order Code		B8484	B8485	B8486	B8487

## BRSCB-I-12.5

### MCB for Surge Arrester

MCB specially designed for Surge Arrester It can cut the leakage current to 3A.

Therefore prevent possible fire hazzard caused by degenerated SPD.

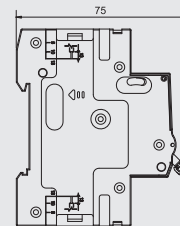
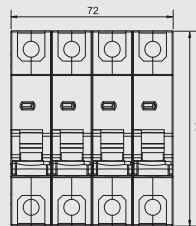
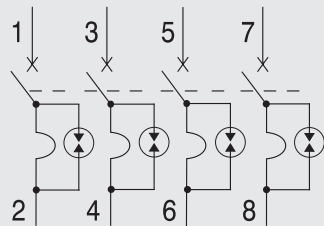

■ Special MCB designed to protect the SPD.

		BRSCB-I-12.5-4P	BRSCB-I-12.5-3P	BRSCB-I-12.5-2P	BRSCB-I-12.5-1P
Nominal a.c. voltage	Un	500V	500V	500V	500V
Impluse current (10/350µs)	Iimp	12.5kA	12.5kA	12.5kA	12.5kA
Nominal discharge current (8/20µs)	In	25kA	25kA	25kA	25kA
Max. discharge current (8/20µs)	I <sub>max</sub>	60kA	60kA	60kA	60kA
Operating temperature range	Tu	-40°C-80°C	-40°C-80°C	-40°C-80°C	-40°C-80°C
Operating state/fault indication		green/red	green/red	green/red	green/red
Cross-section area (Min.)		2.5mm <sup>2</sup>	2.5mm <sup>2</sup>	2.5mm <sup>2</sup>	2.5mm <sup>2</sup>
Cross-section area (Max.)		35mm <sup>2</sup>	35mm <sup>2</sup>	35mm <sup>2</sup>	35mm <sup>2</sup>
For mounting on		35mm Din rail	35mm Din rail	35mm Din rail	35mm Din rail
Enclosure material		Thermoplastic UL94-V0			
Degree of protection		IP20	IP20	IP20	IP20
Order Code		B8488	B8489	B8490	B8491

## BRSCB-80

### MCB for Surge Arrester

MCB specially designed for Surge Arrester It can cut the leakage current to 3A.

Therefore prevent possible fire hazzard caused by degenerated SPD.

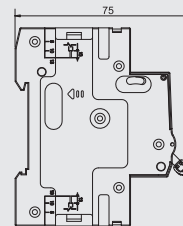
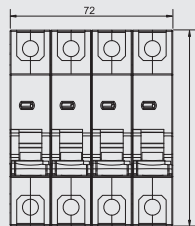
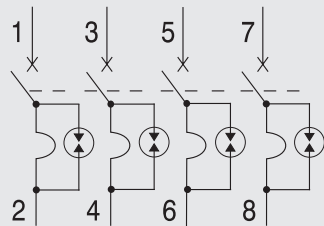

■ Special MCB designed to protect the SPD.

		BRSCB-80-4P	BRSCB-80-3P	BRSCB-80-2P	BRSCB-80-1P
Nominal a.c. voltage	Un	500V	500V	500V	500V
Nominal discharge current (8/20μs)	In	40kA	40kA	40kA	40kA
Max. discharge current (8/20μs)	I <sub>max</sub>	80kA	80kA	80kA	80kA
Operating temperature range	Tu	-40°C-80°C	-40°C-80°C	-40°C-80°C	-40°C-80°C
Operating state/fault indication		green/red	green/red	green/red	green/red
Cross-section area (Min.)		2.5mm <sup>2</sup>	2.5mm <sup>2</sup>	2.5mm <sup>2</sup>	2.5mm <sup>2</sup>
Crosssection area (Max.)		35mm <sup>2</sup>	35mm <sup>2</sup>	35mm <sup>2</sup>	35mm <sup>2</sup>
For mounting on		35mm Din rail	35mm Din rail	35mm Din rail	35mm Din rail
Enclosure material		Thermoplastic UL94-V0			
Degree of protection		IP20	IP20	IP20	IP20
Order Code		B8472	B8473	B8474	B8475

## BRSCB-40

### MCB for Surge Arrester

MCB specially designed for Surge Arrester It can cut the leakage current to 3A.

Therefore prevent possible fire hazzard caused by degenerated SPD.

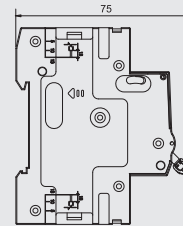
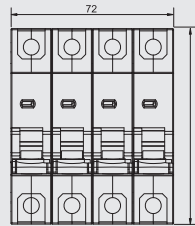
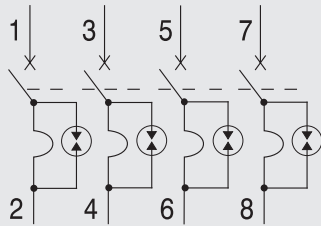

■ Special MCB designed to protect the SPD.

		BRSCB-40-4P	BRSCB-40-3P	BRSCB-40-2P	BRSCB-40-1P
Nominal a.c. voltage	Un	500V	500V	500V	500V
Nominal discharge current (8/20μs)	In	20kA	20kA	20kA	20kA
Max. discharge current (8/20μs)	I <sub>max</sub>	40kA	40kA	40kA	40kA
Operating temperature range	Tu	-40°C-80°C	-40°C-80°C	-40°C-80°C	-40°C-80°C
Operating state/fault indication		green/red	green/red	green/red	green/red
Cross-section area (Min.)		2.5mm <sup>2</sup>	2.5mm <sup>2</sup>	2.5mm <sup>2</sup>	2.5mm <sup>2</sup>
Cross-section area (Max.)		35mm <sup>2</sup>	35mm <sup>2</sup>	35mm <sup>2</sup>	35mm <sup>2</sup>
For mounting on		35mm Din rail	35mm Din rail	35mm Din rail	35mm Din rail
Enclosure material		Thermoplastic UL94-V0			
Degree of protection		IP20	IP20	IP20	IP20
Order Code		B8476	B8477	B8478	B8479

## BRVSPI

Panel Status indicator



By connecting the NC of the remote signaling contact to the x1 and x2 terminal on the BRVI, the working status of the SPD will be shown on the panel status indicator.

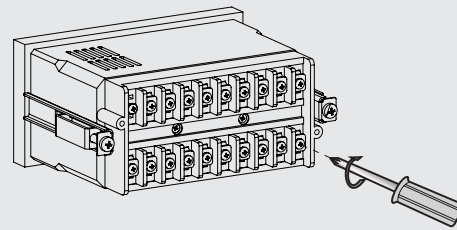
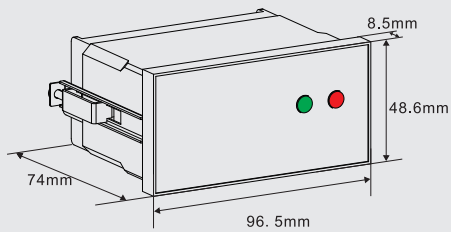

		BRVSPI
Indicator voltage	Un	230V~
Input signal		NC of the Remote Signalling Contact
Status indicator		SPD OK: Green LED on; SPD failure: Red LED on
Mounting		Screw on the panel by steel mounting bracket provided
Operating temperature range	Tu	-20°C...+60°C
Enclosure material		Thermoplastic
Degree of protection		IP20
Order Code		B6300

## BRSC-01

### Surge Counter



Count and record the times of surge current. Automatic memorize the result, the result will not be erased in case of power loss. Can be connected with computers by RS485 output.

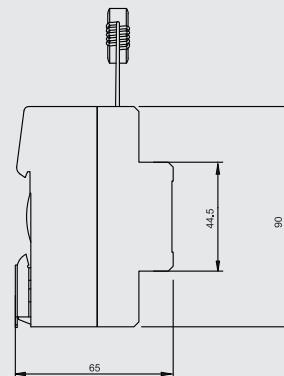
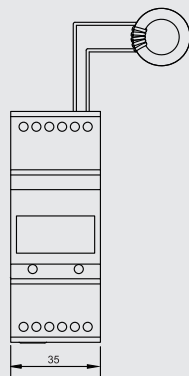

		BRSC-01
Response of impulse current		1kA
Surge counter main voltage	Un	230V~
Surge backup voltage		5-12V
Input signal		PE wire through the hole of the coil
Additional Input signal		2 of switch value
Output signal		Rs485
Count range		0~9999
Mounting		35mm Din Rail
Operating temperature range	Tu	-20°C...+60°C
Enclosure material		Thermoplastic
Degree of protection		IP20
Order Code		B6301

## BRCI

Coordination Inductor

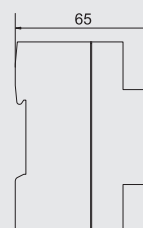
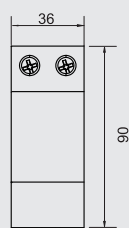
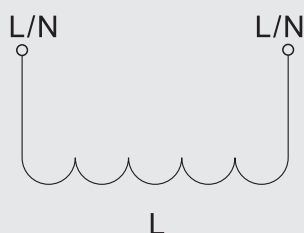

		BRCI-35	BRCI-63
Description		Coordination inductor	Coordination inductor
Max. continuous operating voltage	Uc	500V ac	500V ac
Max. line current	IL	35A	63A
Line inductance		15µH	15µH
Wiring		1 piece in series on each active line	1 piece in series on each active line
Dimension W*L*H		36*90*65mm	36*90*65mm
Connection		6~35mm <sup>2</sup>	6~35mm <sup>2</sup>
Mounting on		35mm Din rail	35mm Din rail
Operating temperature range	Tu	-40°C~80°C	-40°C~80°C
Degree of protection		IP20	IP20
Enclosure material		Thermoplastic UL-94V0	Thermoplastic UL-94V0
Order Code		B6320	B6321

## BRBS

Busbars



Item	Order Code
2P Fork 18F	B6330
3P Fork 18F	B6331
4P Fork 18F	B6332
2P Fork 36F	B6333
3P Fork 36F	B6334
4P Fork 36F	B6335



Item	Order Code
2P Comb 18F	B6336
3P Comb 18F	B6337
4P Comb 18F	B6338
2P Comb 36F	B6339
3P Comb 36F	B6340
4P Comb 36F	B6341

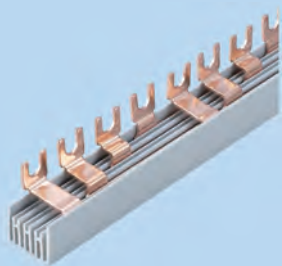

Item	Order Code
2P Fork 18F to MCB	B6342
3P Fork 18F to MCB	B6343
4P Fork 18F to MCB	B6344
2P Fork 36F to MCB	B6345
3P Fork 36F to MCB	B6346
4P Fork 36F to MCB	B6347



Item	Order Code
2P Comb 18F to MCB	B6348
3P Comb 18F to MCB	B6349
4P Comb 18F to MCB	B6350
2P Comb 36F to MCB	B6351
3P Comb 36F to MCB	B6352
4P Comb 36F to MCB	B6353

[www.britecelectric.com](http://www.britecelectric.com)



# **BRITEC**

**Britec Electric Co., Ltd.**

Add: Block1, BoTong HuiGu Industrial Park, Yueqing, Zhejiang, China

Tel: +86-577-6260 5321

Fax: +86-577-6260 5320

E-mail: [britec@britecelectric.com](mailto:britec@britecelectric.com)

Website: [www.britecelectric.com](http://www.britecelectric.com)