

BRITEC

Let all the circuits
get surge protected



Britec Electric Co., Ltd.

www.britecelectric.com



Company Profile

Britec Electric specialized in research and development of lightning protection devices, breakers, fuses and other circuit protection products.

Our products are produced under IEC standard and are 100% tested before leaving factory. Part of the products are certified by Intertek SEMKO, TUV and CE.

Our technical department can develop products according to customer's requirement. We can make the tooling in 45 days. If you have special products needs OEM, we are your ideal partner.

Fully understand the ISO9000 quality management system, the company strictly control the supplier and material for production, the assembly process is standardized and the final checking to be done automatically.

With strict quality control, our products can compete with top brands in the market. We are looking for agents and distributors for our products and is willing to accept OEM orders for customers with same mentality.

In analogy to induced surges, the effects of distant lightning strokes on the electrical system of a structure are controlled by devices and components, which are designed accordingly for impulse current wave 8/20 μ s.

Surges due to switching operations (SEMP) are caused by e.g. switching off inductive load (e.g. transformers, coils, motors), ignition and interruption of electric arcs (e.g. arc welding device), tripping of fuses.

The effects of switching operations in electrical installations of structures can also be simulated with impulse currents of wave form 8/20 μ s for testing purposes.

LEMP protection of structures with electrical and electronic systems according to IEC 62305-4

Lightning Protection Zone	Description
LPZ 0A	Threat by direct lightning strokes, impulse currents up to complete lightning currents and the entire lightning field.
LPZ 0B	Protected against direct lightning strokes. Threat by impulse currents up to partial lightning currents and the entire lightning field.
LPZ 1	Impulse currents are further limited by current distribution and SPDs situated at the zone boundaries. The lightning field is mostly attenuated by spatial shielding.
LPZ 2	Impulse currents are further limited by current distribution and SPDs situated at the zone boundaries. The lightning field is mostly attenuated by spatial shielding.

Power Distribution System:

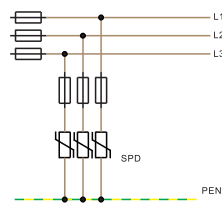

SPD in TN-C system

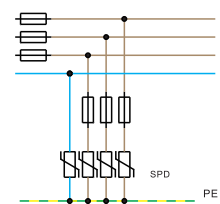

SPD in TN-S system

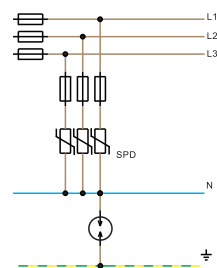

SPD in TT system

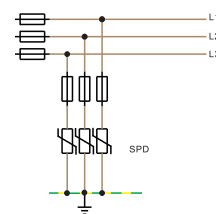

SPD in IT system



Type of surge protectors

The AC power surge protectors have 3 categories by IEC 61643-11 and EN 61643-11 standards, with the following 3 classes of tests. These different tests depend on the location of the surge protector in the AC network and on the external conditions.

Type 1 surge protectors

Type 1 surge protectors are designed to be installed where a direct lightning strike risk is high, especially when the building is equipped with external lightning protection system (LPS or lightning rod). In this situation, EN 61643-11 and IEC 61643-11 standards require the Class I test to be applied to surge protectors : this test is characterized by applying 10/350 μ s impulse current in order to simulate the direct lightning strike consequence. Therefore these Type 1 surge protectors must be especially powerful to conduct this high energy impulse current.

Type 2 surge protectors

Type 2 surge protectors are designed to be installed at the entrance of the installation, in the main switchboard, or close to sensitive terminals, on installations without LPS (lightning rods). These protectors are tested following the Class II test from IEC61643-11 or EN61643-11 standards and based on 8/20 μ s impulse current

Type 3 surge protectors

In case of very sensitive or remote equipment, secondary stage of surge protectors is required : these low energy SPDs could be Type 2 or Type 3 (see Coordination of surge protector page 7). Type 3 SPDs are tested with a combination waveform 1,2/50 μ s voltage - 8/20 μ s current following Class III test.

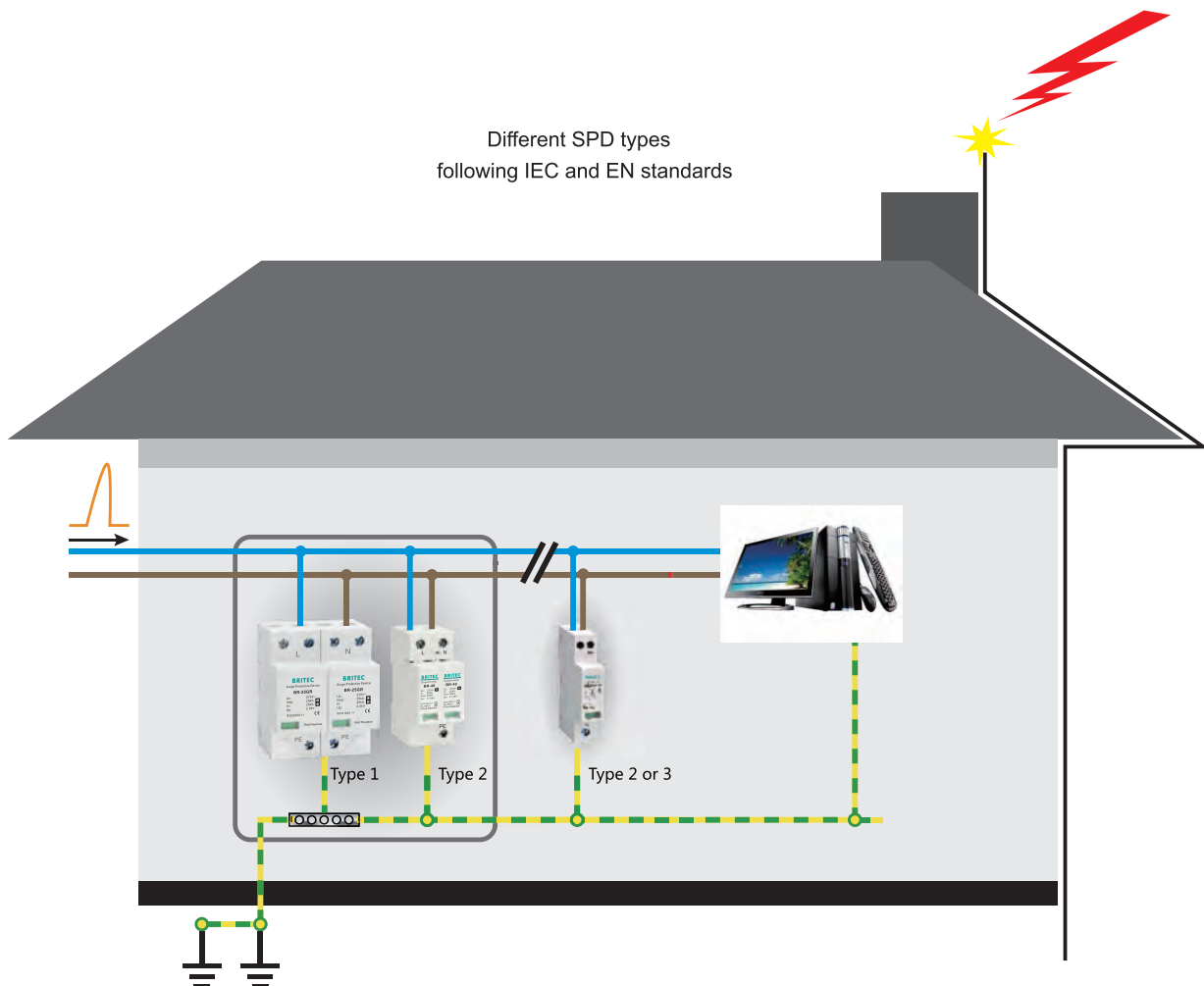

Maintenance

BR surge protectors are designed for repetitive operation and do not require specific maintenance. Nevertheless, in case of an extreme event, a controlled end of life could occur (see above) and a maintenance operation must be performed .

Pluggable design

The design of some BR surge protectors (BR-20, BR-40, BR-80 and BR-12.5M) is based on the use of a pluggable module that plugs into a matching base. This makes replacement, and checking very easy without impairing the protection function. On multipolar surge protectors, the possibility of replacing a single pole makes rehabilitating a surge protector less expensive.

Status Indication

BR surge protectors are equipped with a failure indicator (mechanical or light) linked to the internal thermal disconnecter: in case of safety disconnection, the indicator will switch on and the SPD must be replaced.

Remote Signaling

Most BR surge protectors are available in remote signaling versions. This feature, which allows remote checking of the status of the surge protector, is especially important when the products are hard to reach or unsupervised.

The system consists of an auxiliary changeover contact that is activated if the surge protector module changes status.

This lets the user monitor :

- the good operation of the SPD
- the presence of the plug-in modules (if any)
- the end of life (disconnection) of the surge protector.

The remote signaling version allows the choice of signaling system appropriate to the installation (light, buzzer, automation, modem transmission...).

Disconnection devices

In compliance with the standards, the AC power surge protectors are equipped with external and internal disconnection devices in order to provide total safety in case of failure.

2 types of devices are necessary :

Internal thermal security which will disconnect the surge protector from the AC network in case of thermal runaway. In such a case, the user will be warned about the trouble by an indicator (mechanical or light) in front of the protector and will carry out the replacement of the defective SPD.

External electrical disconnecter (fuses or breaker) to disconnect the surge protector from the AC network in case of internal short circuit, e.g. due to an excessive impulse current. The rating of the external fuses (or breaker) are in relation with the discharge capability of the SPD and the prospective short-circuit current of the installation and must be tested together with the surge protector in order to ensure compliance of the short-circuit current withstand test (Iscpr parameter). To ease the selection of these components, the rating and type of fuses (or breaker) are mentioned in the datasheet and in the installation instructions of each SPD (see Backup Fuses page 4).

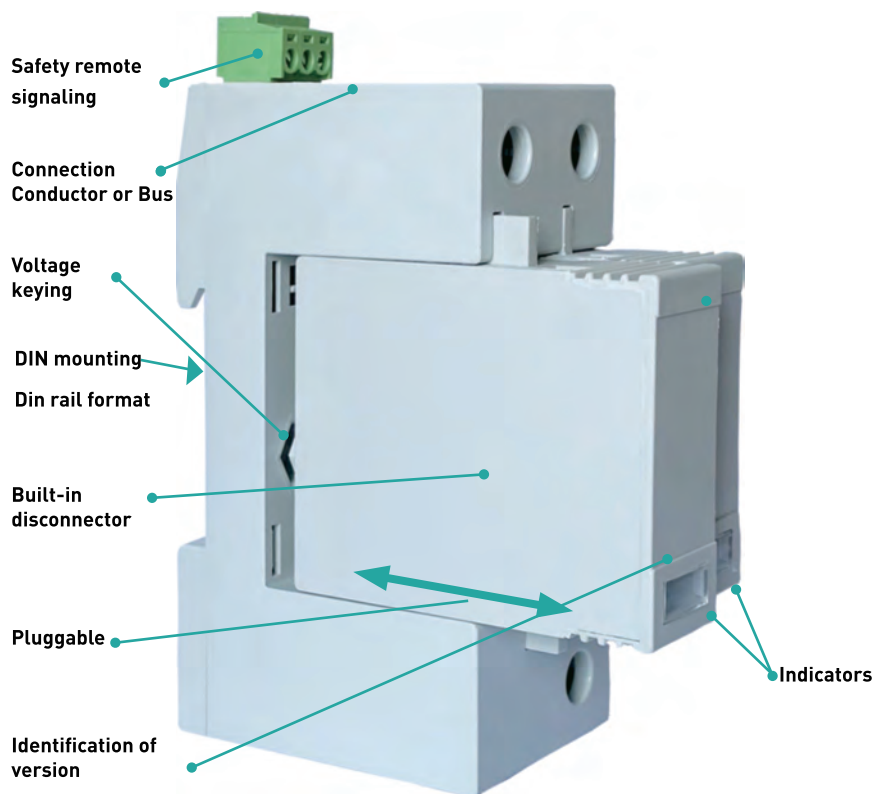



Surge protection installation

Installation Location

BR surge protectors are installed as follows, according to their types:

- **Type 1 or Heavy duty:** at the origin of the installation, in a separate box or on the main electrical panel, for efficient discharge of partial lightning currents.
- **Type 2 or Primary:** at the origin of the installation, on the main electrical panel, in order to eliminate impulses currents as fast as possible and thereby avoid coupling.
- **Type 2 (or Type 3) or Secondary:** on the secondary panel, near the sensitive equipment, to limit ringing and improve the level of protection.

Wiring

Since lightning surges are essentially common-mode phenomena, BR surge protectors are connected mainly in common mode (between the active conductors and ground).

Some recommendations call for additional differential-mode protection (between phase and neutral). For these applications, BRITEC offers specific versions, using a gas tube base module for the Neutral to Ground (differential mode) protection: this type of installation is called a CT2 connection in IEC 60364 standard, is used in surge protectors such as BR-40 3+1.

Common mode protection -CT1 Connection

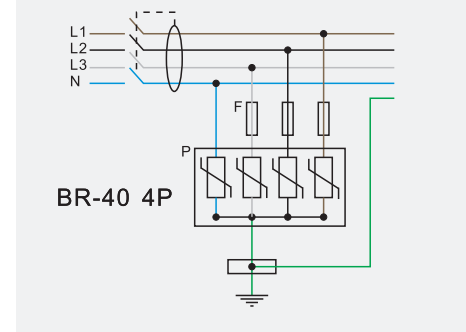

Common and differential mode protection -CT2 Connection

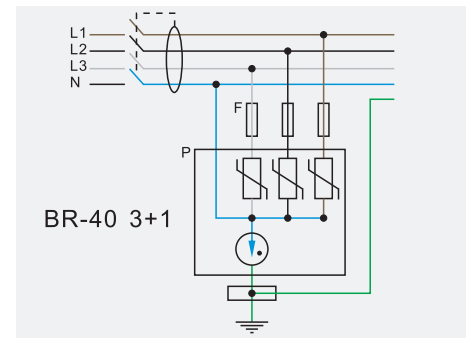

Backup fuses

To comply with standards and safety, the AC surge protectors must be protected against a possible end of life in short-circuit: the user must install on each SPD branch, a protection against short-circuit current (fuses or breaker).

The rating of this fuses is given by the SPD manufacturer in the product datasheet or installation instructions. The choice of this rating eria: depends of 2 criteria :

- Withstand of the short-circuit current tes in the IEC 61643-11 standard: the fuse must cut safety the short-circuit current before an harsh destruction of the SPD.
- Withstand of the discharge currents (I_n or I_{imp}): the fuse must be able to conduct the discharge current of the SPD without blowing.

BRITEC has selected some fuses and DIN rail holders to fit with his SPD range. The fuses equipped with failure indicators to check easily their operating status.

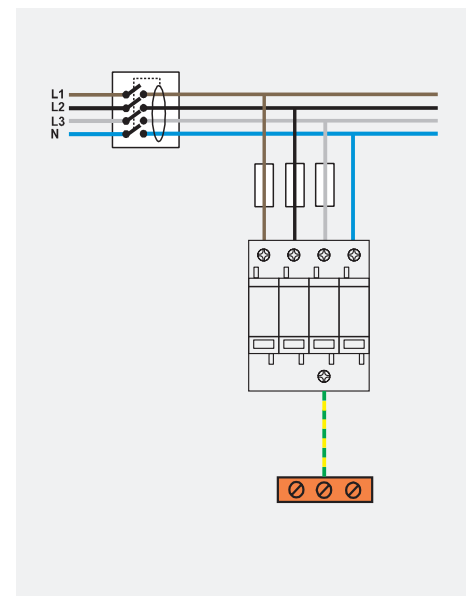



Installation

BR surge protectors are connected in parallel on the AC network and must be equipped with external fuses (or breakers) for short-circuit protection (see paragraph Backup Fuses).

- The total length of connection wires to AC network must be lower than 0.5 m in order not to increase the protection level(Up) provided by the SPD.
- Wiring is made by screw connections. On some models, a distribution bus can be used.
- The protection wire coming from the SPD must be connected to the bonding bar of the electrical panel. Paralleling the protection wire with phases conductors must be avoided.
- The cross sectional wire must be 6 mm² minimum for Type 2 SPD's and 16 mm² for Type 1.
- Local earthing resistance must be in compliance with the electrical rules.

Further information can be found in IEC 61643-12 standard (selection and application principles for low voltage SPD).

Installation example (Type 2 surge arrester BR-40 3+1)

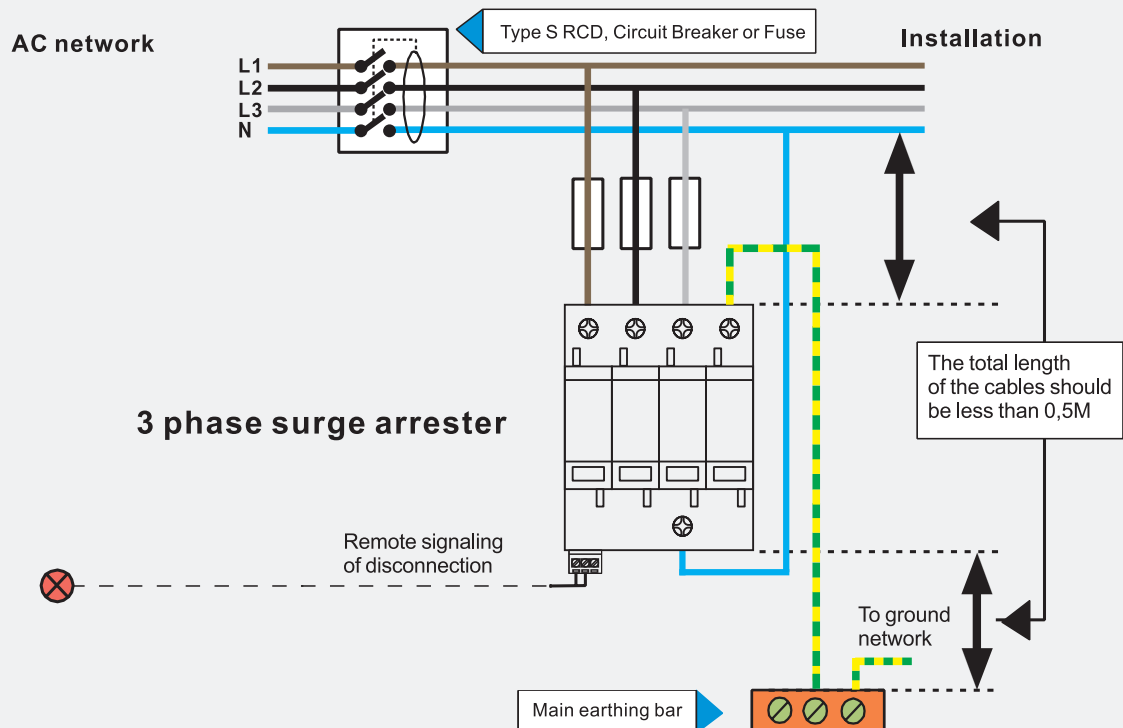



Choosing Surge Protectors

BRITEC's line of AC power surge protectors is designed to cover all possible configurations in low voltage installations. They are available in many versions, which differ in:

- Type or test class (1, 2 or 3)
- Operating voltage (Uc)
- AC network configuration (Single/3-Phase)
- Discharge currents (Iimp, I_{max}, I_n)
- Protection level (Up)
- Protection technology (varistors, VG technology, filter)
- Features (differential mode, plug-in, remote signaling, compact..).

The surge protection selection must be done following the local electrical code requirements (e.g. : minimum rating for I_n) and specific conditions (e.g. : high lightning density).

Choosing the Type of surge protectors

The type of surge protector is based on its location and the constraints of the installation to be protected.

ConfigurationSPD	Type	Location	BRITEC
Installation equipped with LPS or could be hit by lightning	Type 1+2 Type 1+2+3	Origin of the installation origin (Panel or main switchboard)	BR-25GR BR-50GR BR-7M BR-12.5M BR-25M
Installation without LPS	Type 2 Type 2+3	main switchboard	BR-20, BR-40 BR-80, BR-100
Secondary protection (downstream primary SPD)	Type 2 (or Type 3)	close to protected equipment	BR-15DP BR-20DP BR275-6

Choosing the operating voltages Uc and UT

The SPD Uc voltage (maximum continuous operating voltage) depends on:

- Nominal voltage of the AC network (U_o)
- Type of AC system (TN, TT, IT).

The level of resistance to temporary overvoltages (UT) is related to the Uc voltage. In addition, withstanding the "high voltage" TOV (1200 Vac, 300A, 200 ms) between Neutral and PE is needed in TT AC system, which requires the CT2 diagram.

Operating voltage Uc (Line/Ground)

AC Network	230/400V			120/208V
	TT	TN	IT	TN
Voltage Uc mini	255V	255V	440V	135V
Voltage U _T	335/440V	335/440V	-	230/175V
TOV N/PE	1200V			
Example of BRITEC product	BR-40 275TT	BR-40 275	BR-40 400	BR-40 150

AC network configuration

BR surge protectors are available for single, 3-Phase and 3-Phase + neutral AC networks.

Choosing Iimp

The impulse current Iimp is defined for Type 1 SPD. The minimum rating for Iimp is 12.5 kA by pole, following IEC 60364-5- 534 . This level is adapted to the real phenomenon. This value can, however, be increased according to the risk (calculation according to EN 62305-1) BRITEC proposes, in its Type 1 SPD range, 3 levels of Iimp current by pole: 12.5, 25 and 50 kA.

Configuration	Iimp/pole	BRITEC
Maximum risk	50 kA	BR-50GR
Very high lightning density Bad earthing	25 kA	BR-25GR BR-25M
High, medium or low lightning density	12.5 kA	BR-12.5GR BR-12.5M

Choosing I_n current

The relevant nominal discharge current I_n for the SPD is in relation with the lightning risk in the installation area.

The minimum rating of I_n for a SPD connected at the installation entrance is 5 kA (8/20 μs waveform), required by standard. Nevertheless higher ratings are advised in case of high lightning density. Moreover higher values of I_n current will increase the SPD lifetime. I_{max} (max. discharge current) rating is linked to I_n.

Conditions	I _n	BRITEC
Very high lightning density	> 20 kA	BR-80
High or medium lightning density	10-20 kA	BR-40 BR-20
Low lightning density or secondary SPD	5 kA	BR-10DP BR275-6

Choosing the protection level Up

The user must select a surge protector with a protection level Up adapted to the withstand level of terminal equipment. In every case, the lower the protection level Up, the better the protection.

IEC 60364 standard calls for the minimum protection level of 2.5 kV for a SPD connected at the entrance of a 230/400 V network : this level is in compliance with the withstand of robust devices (electromechanical type).

Electronic-based terminals have lower impulse withstand and require a better protection : so, surge protectors with 1.5 kV protection are necessary to provide efficient protection.

Conditions	Recommended Up	
	230/400 V AC network	120/208 V AC network
SPD at the installation entrance	2.5 kV max.	1.5 kV max.
Electromechanical protected equipment	2.5 kV	1.5 kV
Electronic-based protected equipment	1.5 kV	0.8 kV

Choosing the SPD technology

A relevant choice of the SPD technology, as well as the use of coordination diagram can help to improve the protection level.

BR surge protectors are based on Varistor (MOV) technology.

Some versions use different electrical diagrams in order to improve some of their characteristics :

-VG technology:

this Gas tube-Varistor combined SPD improves the reliability and and the efficiency.

- Multigap sparkgap technology

This kind of surge protector can discharge large impulse current.

It can also has a high follow up current due to the product consists by many sparkgaps

Product such as BR-25GR and BR-12.5GR are based on this technology.

This coordination is required in the 2 following cases :

-High sensitivity equipment :

➔ Improvement of protection level.

- Long distance (greater than 30 m) of wire between equipment to be protected and primary SPD :

➔ Reduction of ringing voltages created during the surge transmission.

Efficient SPD coordination is performed by including between primary and secondary SPDs :

- a minimum length of wire (> 10 m).

or

- a decoupling coil.

Coordination of Surge Protector

Coordination of Surge Protectors

In order to provide maximum protection efficiency, it is necessary to create a coordination diagram, that means installation of a primary SPD at the network entrance and a secondary close to sensitive equipment.

Coordination by conductor

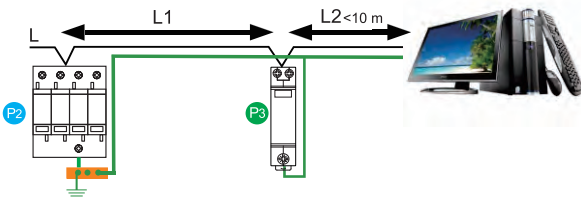

In order to provide maximum protection efficiency, it is necessary to create a coordination diagram: that means installation of a primary SPD at the network entrance and a secondary close to sensitive equipment.

Efficient SPD coordination is performed by including, between primary and secondary SPDs :

-a minimum length of wire (> 10 m).

or

-coordination inductors (BR-CC range: see below).

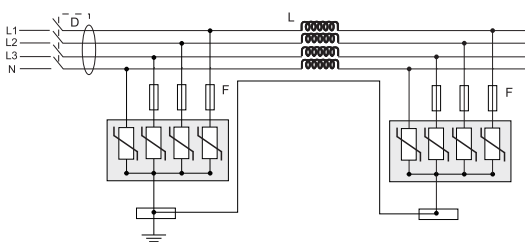

Coordination by inductor

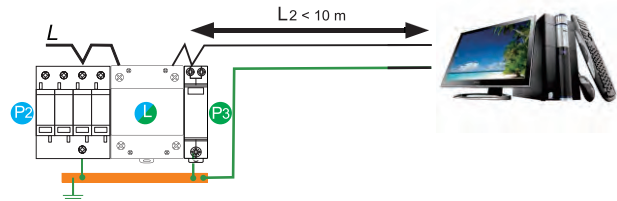

P2 : Primary surge protector (ex. BR-40)

P3 : Secondary surge protector (ex. BR-20DP)

L : Coordination inductors (ex. BR-CC)

L1 : Length of conductor between surge protector

L2 : Length of conductor between surge protector and installation

Example of coordination on 3-Phase network.

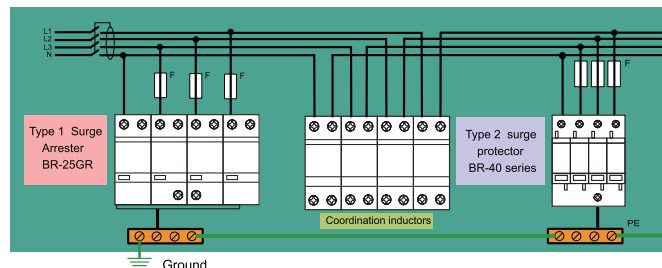

D : Breaker
F : Backup disconnector
(fuse or circuit-breaker)
L : Coordination inductor



Type 1 Surge Arrester

BR-50GR 4P Type1 Surge Arrester

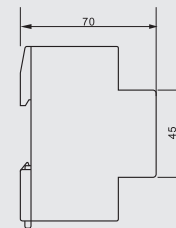
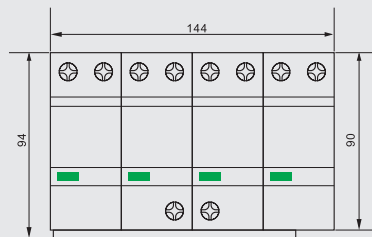
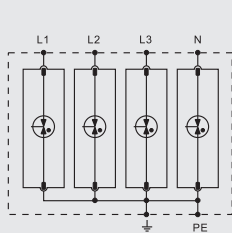

■ BR-50GR 4P is suitable for TN-S system.

	BR-50GR 150 4P	BR-50GR 275 4P	BR-50GR 320 4P
SPD classification according to EN61643-11	Type 1 + Type 2	Type 1 + Type 2	Type 1 + Type 2
SPD classification according to IEC61643-11	Class I + Class II	Class I + Class II	Class I + Class II
Max. continuous operating a.c. voltage	Uc	150V (50/60Hz)	275V (50/60Hz)
Lightning impulse current (10/350µs)	Iimp	50kA	50kA
Nominal discharge current (8/20µs)	In	50kA	50kA
Maximum discharge current (8/20µs)	I _{max}	200kA	200kA
Quantity of electric charge	Q	25As	25As
Specific energy	W/R	625kJ/Ω	625kJ/Ω
Voltage protection level	Up	≤2.0kV	≤2.0kV
Short-circuit current rating a.c.	I _{sc}	25kA rms	25kA rms
Max. backup fuse		350A gG	350A gG
Temporary overvoltage	TOV	230V/120min-withstand	440V/120min -withstand
Response time	t _A	≤100ns	≤100ns
Operating temperature range	T _u	-40°C-80°C	-40°C-80°C
Cross-section area (Min.)		4mm ²	4mm ²
Cross-section area(Max.)		35mm ²	35mm ²
For mounting on		35mm Din rail	35mm Din rail
Enclosure material		Thermoplastic UL94-V0	Thermoplastic UL94-V0
Degree of protection		IP20	IP20
Order Code		B7158	B7184
Order Code (With remote signaling)		B7159	B7185

BR-50GR 3P

Type1 Surge Arrester

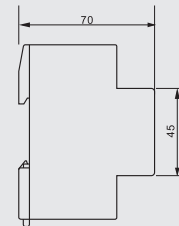
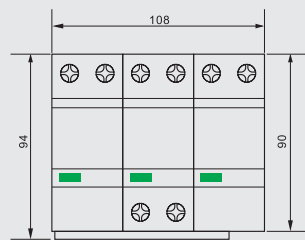
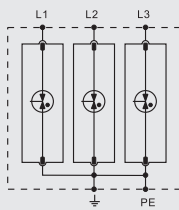

■ BR-50GR 3P is suitable for TN-C system.

	BR-50GR 150 3P	BR-50GR 275 3P	BR-50GR 320 3P
SPD classification according to EN61643-11	Type 1 + Type 2	Type 1 + Type 2	Type 1 + Type 2
SPD classification according to IEC61643-11	Class I + Class II	Class I + Class II	Class I + Class II
Max. continuous operating a.c. voltage	Uc	150V (50/60Hz)	275V (50/60Hz)
Lightning impulse current (10/350µs)	Iimp	50kA	50kA
Nominal discharge current (8/20µs)	In	50kA	50kA
Maximum discharge current (8/20µs)	I _{max}	200kA	200kA
Quantity of electric charge	Q	25As	25As
Specific energy	W/R	625kJ/Ω	625kJ/Ω
Voltage protection level	Up	≤ 2.0kV	≤ 2.0kV
Short-circuit current rating a.c.	I _{sc}	25kA rms	25kA rms
Max. backup fuse		350A gG	350A gG
Temporary overvoltage	TOV	230V/120min-withstand	440V/120min -withstand
Response time	t _A	≤ 100ns	≤ 100ns
Operating temperature range	T _u	-40°C-80°C	-40°C-80°C
Cross-section area (Min.)		4mm ²	4mm ²
Cross-section area(Max.)		35mm ²	35mm ²
For mounting on		35mm Din rail	35mm Din rail
Enclosure material		Thermoplastic UL94-V0	Thermoplastic UL94-V0
Degree of protection		IP20	IP20
Order Code		B7160	B7186
Order Code (With remote signaling)		B7161	B7187

BR-50GR 2P Type 1 Surge Arrester

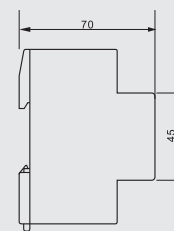
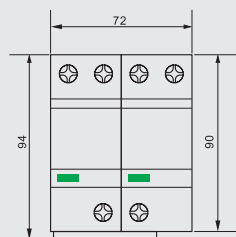
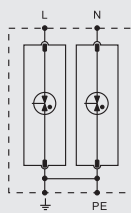

■ BR-50GR 2P surge arrester is suitable for single phase TN system.

	BR-50GR 150 2P	BR-50GR 275 2P	BR-50GR 320 2P
SPD classification according to EN61643-11	Type 1 + Type 2	Type 1 + Type 2	Type 1 + Type 2
SPD classification according to IEC61643-11	Class I + Class II	Class I + Class II	Class I + Class II
Max. continuous operating a.c. voltage	Uc	275V (50/60Hz)	320V (50/60Hz)
Lightning impulse current (10/350μs)	Iimp	50kA	50kA
Nominal discharge current (8/20μs)	In	50kA	50kA
Maximum discharge current (8/20μs)	I _{max}	200kA	200kA
Quantity of electric charge	Q	25As	25As
Specific energy	W/R	625kJ/Ω	625kJ/Ω
Voltage protection level	Up	≤ 2.0kV	≤ 2.0kV
Short-circuit current rating a.c.	I _{sc}	25kA rms	25kA rms
Max. backup fuse		350A gG	350A gG
Temporary overvoltage	TOV	230V/120min-withstand	440V/120min-withstand
Response time	t _A	≤ 100ns	≤ 100ns
Operating temperature range	T _u	-40°C-80°C	-40°C-80°C
Cross-section area (Min.)		4mm ²	4mm ²
Cross-section area(Max.)		35mm ²	35mm ²
For mounting on		35mm Din rail	35mm Din rail
Enclosure material		Thermoplastic UL94-V0	Thermoplastic UL94-V0
Degree of protection		IP20	IP20
Order Code		B7162	B7188
Order Code (With remote signaling)		B7163	B7189

BR-50GR 1P Type 1 Surge Arrester

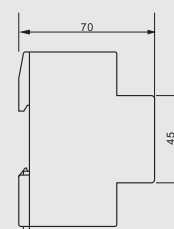
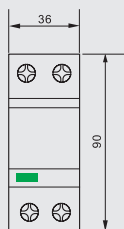
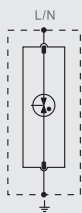

BR-50GR 1P can be used to build 2P, 3P and 4P surge arresters.

	BR-50GR 150 1P	BR-50GR 275 1P	BR-50GR 320 1P
SPD classification according to EN61643-11	Type 1 + Type 2	Type 1 + Type 2	Type 1 + Type 2
SPD classification according to IEC61643-11	Class I + Class II	Class I + Class II	Class I + Class II
Max. continuous operating a.c. voltage	Uc	150V (50/60Hz)	275V (50/60Hz)
Lightning impulse current (10/350µs)	Iimp	50kA	50kA
Nominal discharge current (8/20µs)	In	50kA	50kA
Maximum discharge current (8/20µs)	I _{max}	200kA	200kA
Quantity of electric charge	Q	25As	25As
Specific energy	W/R	625kJ/Ω	625kJ/Ω
Voltage protection level	Up	≤ 2.0kV	≤ 2.0kV
Short-circuit current rating a.c.	I _{sc}	25kA rms	25kA rms
Max. backup fuse		350A gG	350A gG
Temporary overvoltage	TOV	230V/120min-withstand	440V/120min -withstand
Response time	t _A	≤ 100ns	≤ 100ns
Operating temperature range	T _u	-40°C-80°C	-40°C-80°C
Cross-section area (Min.)		4mm ²	4mm ²
Cross-section area(Max.)		35mm ²	35mm ²
For mounting on		35mm Din rail	35mm Din rail
Enclosure material		Thermoplastic UL94-V0	Thermoplastic UL94-V0
Degree of protection		IP20	IP20
Order Code		B7164	B7190
Order Code (With remote signaling)		B7165	B7191



BR-50GR 3+1 Type 1 Surge Arrester

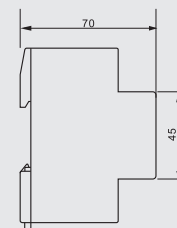
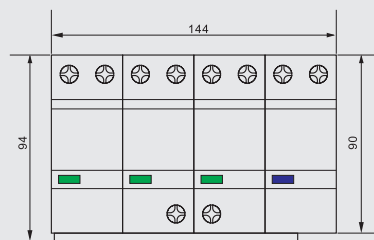
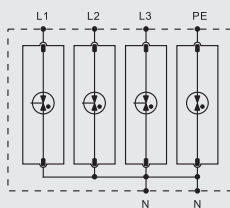

■ BR-50GR 3+1 surge arrester is suitable for TT and TN-S system.

		BR-50GR 150 3+1	BR-50GR 275 3+1	BR-50GR 320 3+1
SPD classification according to EN61643-11		Type 1 + Type 2	Type 1 + Type 2	Type 1 + Type 2
SPD classification according to IEC61643-11		Class I + Class II	Class I + Class II	Class I + Class II
Max. continuous operating a.c. voltage	Uc (L-N/N-PE)	150V/255V (50/60Hz)	275V/255V (50/60Hz)	320V/255V (50/60Hz)
Lightning impulse current (10/350µs)	Iimp (L-N/N-PE)	50kA/100kA	50kA/100kA	50kA/100kA
Nominal discharge current (8/20µs)	In (L-N/N-PE)	50kA/100kA	50kA/100kA	50kA/100kA
Maximum discharge current (8/20µs)	I _{max} (L-N/N-PE)	200kA/200kA	200kA/200kA	200kA/200kA
Quantity of electric charge (L-N,N-PE)	Q	25As, 50As	25As, 50As	25As, 50As
Specific energy (L-N,N-PE)	W/R	625kJ/Ω, 2500kJ/Ω	625kJ/Ω, 2500kJ/Ω	625kJ/Ω, 2500kJ/Ω
Voltage protection level	Up (L-N/N-PE)	≤ 2.0kV/≤ 1.5kV	≤ 2.0kV/≤ 1.5kV	≤ 2.0kV/≤ 1.5kV
Short-circuit current rating a.c.	IscCR (L-N/N-PE)	25kA rms/100A rms	25kA rms/100A rms	25kA rms/100A rms
Max. backup fuse		350A gG	350A gG	350A gG
Temporary overvoltage	TOV (L-N)	230V/120min-withstand	440V/120min-withstand	520V/120min-withstand
Temporary overvoltage	TOV (N-PE)	1200V/200ms-withstand	1200V/200ms-withstand	1200V/200ms-withstand
Response time	t _A	≤ 100ns	≤ 100ns	≤ 100ns
Operating temperature range	T _u	-40°C-80°C	-40°C-80°C	-40°C-80°C
Cross-section area (Min.)		4mm ²	4mm ²	4mm ²
Cross-section area(Max.)		35mm ²	35mm ²	35mm ²
For mounting on		35mm Din rail	35mm Din rail	35mm Din rail
Enclosure material		Thermoplastic UL94-V0	Thermoplastic UL94-V0	Thermoplastic UL94-V0
Degree of protection		IP20	IP20	IP20
Order Code		B7166	B8167	B7192
Order Code (With remote signaling)		B7167	B8168	B7193

BR-50GR 1+1 Type 1 Surge Arrester

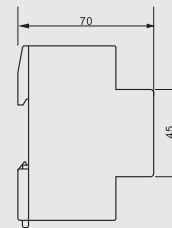
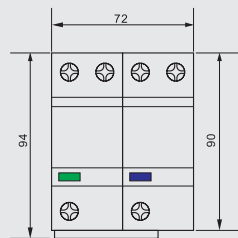
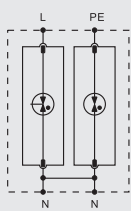

■ BR-50GR 1+1 surge arrester is suitable for TT and TN-S system.

		BR-50GR 150 1+1	BR-50GR 275 1+1	BR-50GR 320 1+1
SPD classification according to EN61643-11		Type 1 + Type 2	Type 1 + Type 2	Type 1 + Type 2
SPD classification according to IEC61643-11		Class I + Class II	Class I + Class II	Class I + Class II
Max. continuous operating a.c. voltage	Uc (L-N/N-PE)	150V/255V (50/60Hz)	275V/255V (50/60Hz)	320V/255V (50/60Hz)
Lightning impulse current (10/350µs)	Iimp (L-N/N-PE)	50kA/100kA	50kA/100kA	50kA/100kA
Nominal discharge current (8/20µs)	In (L-N/N-PE)	50kA/100kA	50kA/100kA	50kA/100kA
Maximum discharge current (8/20µs)	I _{max} (L-N/N-PE)	200kA/200kA	200kA/200kA	200kA/200kA
Quantity of electric charge (L-N,N-PE)	Q	25As, 50As	25As, 50As	25As, 50As
Specific energy (L-N,N-PE)	W/R	625kJ/Ω, 2500kJ/Ω	625kJ/Ω, 2500kJ/Ω	625kJ/Ω, 2500kJ/Ω
Voltage protection level	Up (L-N/N-PE)	≤ 2.0kV/≤ 1.5kV	≤ 2.0kV/≤ 1.5kV	≤ 2.0kV/≤ 1.5kV
Short-circuit current rating a.c.	IscCr (L-N/N-PE)	25kA rms/100A rms	25kA rms/100A rms	25kA rms/100A rms
Max. backup fuse		350A gG	350A gG	350A gG
Temporary overvoltage	TOV (L-N)	230V/120min-withstand	440V/120min-withstand	520V/120min-withstand
Temporary overvoltage	TOV (N-PE)	1200V/200ms-withstand	1200V/200ms-withstand	1200V/200ms-withstand
Response time	t _A	≤ 100ns	≤ 100ns	≤ 100ns
Operating temperature range	T _u	-40°C-80°C	-40°C-80°C	-40°C-80°C
Cross-section area (Min.)		4mm ²	4mm ²	4mm ²
Cross-section area(Max.)		35mm ²	35mm ²	35mm ²
For mounting on		35mm Din rail	35mm Din rail	35mm Din rail
Enclosure material		Thermoplastic UL94-V0	Thermoplastic UL94-V0	Thermoplastic UL94-V0
Degree of protection		IP20	IP20	IP20
Order Code		B7168	B8157	B7194
Order Code (With remote signaling)		B7169	B8158	B7195

BR-25GR 4P Type1 Surge Arrester

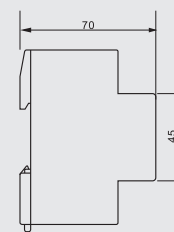
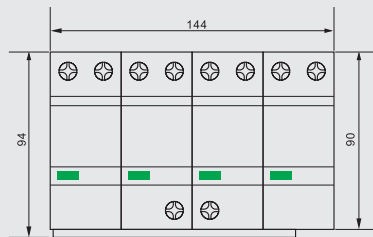
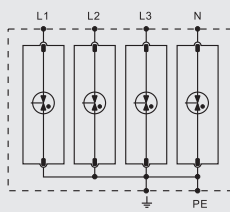

■ BR-25GR 4P is suitable for TN-S system.

	BR-25GR 150 4P	BR-25GR 275 4P	BR-25GR 320 4P
SPD classification according to EN61643-11	Type 1 + Type 2	Type 1 + Type 2	Type 1 + Type 2
SPD classification according to IEC61643-11	Class I + Class II	Class I + Class II	Class I + Class II
Max. continuous operating a.c. voltage	Uc	150V (50/60Hz)	275V (50/60Hz)
Lightning impulse current (10/350µs)	Iimp	25kA	25kA
Nominal discharge current (8/20µs)	In	25kA	25kA
Maximum discharge current (8/20µs)	I _{max}	100kA	100kA
Quantity of electric charge	Q	12.5As	12.5As
Specific energy	W/R	156kJ/Ω	156kJ/Ω
Voltage protection level	Up	≤2.0kV	≤2.0kV
Short-circuit current rating a.c.	I _{sc}	25kA rms	25kA rms
Max. backup fuse		315A gG	315A gG
Temporary overvoltage	TOV	230V/120min-withstand	440V/120min -withstand
Response time	t _A	≤100ns	≤100ns
Operating temperature range	T _u	-40°C-80°C	-40°C-80°C
Cross-section area (Min.)		4mm ²	4mm ²
Cross-section area(Max.)		35mm ²	35mm ²
For mounting on		35mm Din rail	35mm Din rail
Enclosure material		Thermoplastic UL94-V0	Thermoplastic UL94-V0
Degree of protection		IP20	IP20
Order Code		B7120	B7146
Order Code (With remote signaling)		B7121	B7147

BR-25GR 3P Type1 Surge Arrester

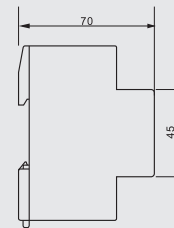
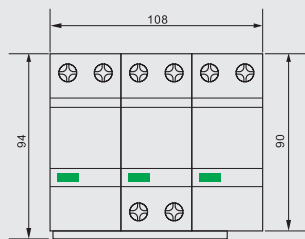
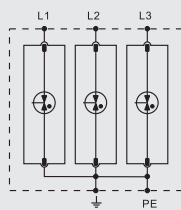

■ BR-25GR 3P is suitable for TN-C system.

	BR-25GR 150 3P	BR-25GR 275 3P	BR-25GR 320 3P
SPD classification according to EN61643-11	Type 1 + Type 2	Type 1 + Type 2	Type 1 + Type 2
SPD classification according to IEC61643-11	Class I + Class II	Class I + Class II	Class I + Class II
Max. continuous operating a.c. voltage	Uc	150V (50/60Hz)	275V (50/60Hz)
Lightning impulse current (10/350µs)	Iimp	25kA	25kA
Nominal discharge current (8/20µs)	In	25kA	25kA
Maximum discharge current (8/20µs)	I _{max}	100kA	100kA
Quantity of electric charge	Q	12.5As	12.5As
Specific energy	W/R	156kJ/Ω	156kJ/Ω
Voltage protection level	Up	≤ 2.0kV	≤ 2.0kV
Short-circuit current rating a.c.	I _{sc}	25kA rms	25kA rms
Max. backup fuse		315A gG	315A gG
Temporary overvoltage	TOV	230V/120min-withstand	440V/120min-withstand
Response time	t _A	≤ 100ns	≤ 100ns
Operating temperature range	T _u	-40°C-80°C	-40°C-80°C
Cross-section area (Min.)		4mm ²	4mm ²
Cross-section area(Max.)		35mm ²	35mm ²
For mounting on		35mm Din rail	35mm Din rail
Enclosure material		Thermoplastic UL94-V0	Thermoplastic UL94-V0
Degree of protection		IP20	IP20
Order Code		B7122	B7135
Order Code (With remote signaling)		B7123	B7136

BR-25GR 2P Type 1 Surge Arrester

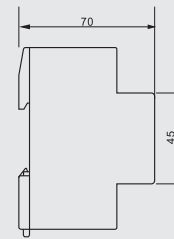
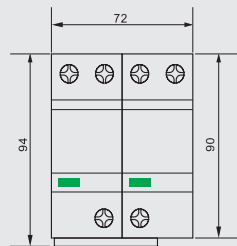
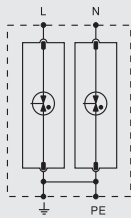

■ BR-25GR 2P surge arrester is suitable for single phase TN system.

	BR-25GR 150 2P	BR-25GR 275 2P	BR-25GR 320 2P
SPD classification according to EN61643-11	Type 1 + Type 2	Type 1 + Type 2	Type 1 + Type 2
SPD classification according to IEC61643-11	Class I + Class II	Class I + Class II	Class I + Class II
Max. continuous operating a.c. voltage	Uc	150V (50/60Hz)	275V (50/60Hz)
Lightning impulse current (10/350µs)	Iimp	25kA	25kA
Nominal discharge current (8/20µs)	In	25kA	25kA
Maximum discharge current (8/20µs)	I _{max}	100kA	100kA
Quantity of electric charge	Q	12.5As	12.5As
Specific energy	W/R	156kJ/Ω	156kJ/Ω
Voltage protection level	Up	≤ 2.0kV	≤ 2.0kV
Short-circuit current rating a.c.	I _{sc}	25kA rms	25kA rms
Max. backup fuse		315A gG	315A gG
Temporary overvoltage	TOV	230V/120min-withstand	440V/120min-withstand
Response time	t _A	≤ 100ns	≤ 100ns
Operating temperature range	T _u	-40°C-80°C	-40°C-80°C
Cross-section area (Min.)		4mm ²	4mm ²
Cross-section area(Max.)		35mm ²	35mm ²
For mounting on		35mm Din rail	35mm Din rail
Enclosure material		Thermoplastic UL94-V0	Thermoplastic UL94-V0
Degree of protection		IP20	IP20
Order Code		B7124	B7150
Order Code (With remote signaling)		B7125	B7151

BR-25GR 1P Type1 Surge Arrester

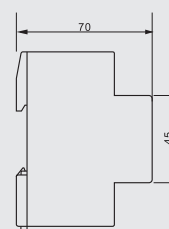
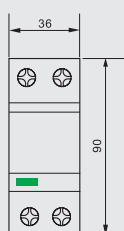

■ BR-25GR 1P can be used to build 2P, 3P and 4P surge arresters.

	BR-25GR 150 1P	BR-25GR 275 1P	BR-25GR 320 1P
SPD classification according to EN61643-11	Type 1 + Type 2	Type 1 + Type 2	Type 1 + Type 2
SPD classification according to IEC61643-11	Class I + Class II	Class I + Class II	Class I + Class II
Max. continuous operating a.c. voltage	Uc	150V (50/60Hz)	275V (50/60Hz)
Lightning impulse current (10/350µs)	Iimp	25kA	25kA
Nominal discharge current (8/20µs)	In	25kA	25kA
Maximum discharge current (8/20µs)	I _{max}	100kA	100kA
Quantity of electric charge	Q	12.5As	12.5As
Specific energy	W/R	156kJ/Ω	156kJ/Ω
Voltage protection level	Up	≤ 2.0kV	≤ 2.0kV
Short-circuit current rating a.c.	I _{sc}	25kA rms	25kA rms
Max. backup fuse		315A gG	315A gG
Temporary overvoltage	TOV	230V/120min-withstand	440V/120min -withstand
Response time	t _A	≤ 100ns	≤ 100ns
Operating temperature range	T _u	-40°C-80°C	-40°C-80°C
Cross-section area (Min.)		4mm ²	4mm ²
Cross-section area(Max.)		35mm ²	35mm ²
For mounting on		35mm Din rail	35mm Din rail
Enclosure material		Thermoplastic UL94-V0	Thermoplastic UL94-V0
Degree of protection		IP20	IP20
Order Code		B7126	B7139
Order Code (With remote signaling)		B7127	B7153

BR-25GR 3+1 Type 1 Surge Arrester

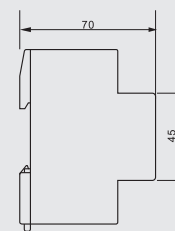
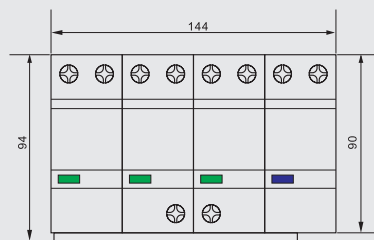
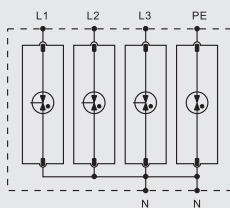

■ BR-25GR 3+1 surge arrester is suitable for TT and TN-S system.

		BR-25GR 150 3+1	BR-25GR 275 3+1	BR-25GR 320 3+1
SPD classification according to EN61643-11		Type 1 + Type 2	Type 1 + Type 2	Type 1 + Type 2
SPD classification according to IEC61643-11		Class I + Class II	Class I + Class II	Class I + Class II
Max. continuous operating a.c. voltage	Uc (L-N/N-PE)	150V/255V (50/60Hz)	275V/255V (50/60Hz)	320V/255V (50/60Hz)
Lightning impulse current (10/350µs)	Iimp (L-N/N-PE)	25kA/100kA	25kA/100kA	25kA/100kA
Nominal discharge current (8/20µs)	In (L-N/N-PE)	25kA/100kA	25kA/100kA	25kA/100kA
Maximum discharge current (8/20µs)	I _{max} (L-N/N-PE)	100kA/200kA	100kA/200kA	100kA/200kA
Quantity of electric charge (L-N,N-PE)	Q	12.5As, 50As	12.5As, 50As	12.5As, 50As
Specific energy (L-N,N-PE)	W/R	156kJ/Ω, 2500kJ/Ω	156kJ/Ω, 2500kJ/Ω	156kJ/Ω, 2500kJ/Ω
Voltage protection level	Up (L-N/N-PE)	≤ 2.0kV/≤ 1.5kV	≤ 2.0kV/≤ 1.5kV	≤ 2.0kV/≤ 1.5kV
Short-circuit current rating a.c.	I _{scrr} (L-N/N-PE)	25kA rms/100A rms	25kA rms/100A rms	25kA rms/100A rms
Max. backup fuse		315A gG	315A gG	315A gG
Temporary overvoltage	TOV (L-N)	230V/120min-withstand	440V/120min-withstand	520V/120min-withstand
Temporary overvoltage	TOV (N-PE)	1200V/200ms-withstand	1200V/200ms-withstand	1200V/200ms-withstand
Response time	t _A	≤ 100ns	≤ 100ns	≤ 100ns
Operating temperature range	T _u	-40°C-80°C	-40°C-80°C	-40°C-80°C
Cross-section area (Min.)		4mm ²	4mm ²	4mm ²
Cross-section area(Max.)		35mm ²	35mm ²	35mm ²
For mounting on		35mm Din rail	35mm Din rail	35mm Din rail
Enclosure material		Thermoplastic UL94-V0	Thermoplastic UL94-V0	Thermoplastic UL94-V0
Degree of protection		IP20	IP20	IP20
Order Code		B7128	B7141	B7154
Order Code (With remote signaling)		B7129	B7142	B7155

BR-25GR 1+1 Type 1 Surge Arrester

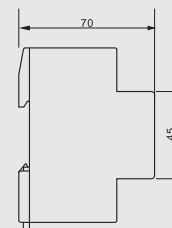
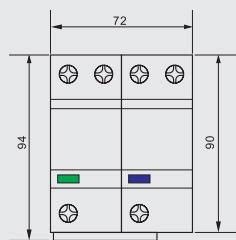
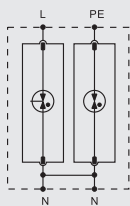

BR-25GR 1+1 surge arrester is suitable for TT and TN-S system.

		BR-25GR 150 1+1	BR-25GR 275 1+1	BR-25GR 320 1+1
SPD classification according to EN61643-11		Type 1 + Type 2	Type 1 + Type 2	Type 1 + Type 2
SPD classification according to IEC61643-11		Class I + Class II	Class I + Class II	Class I + Class II
Max. continuous operating a.c. voltage	U _c (L-N/N-PE)	150V/255V (50/60Hz)	275V/255V (50/60Hz)	320V/255V (50/60Hz)
Lightning impulse current (10/350μs)	I _{imp} (L-N/N-PE)	25kA/50kA	25kA/50kA	25kA/50kA
Nominal discharge current (8/20μs)	I _n (L-N/N-PE)	25kA/50kA	25kA/50kA	25kA/50kA
Maximum discharge current (8/20μs)	I _{max} (L-N/N-PE)	100kA/100kA	100kA/100kA	100kA/100kA
Quantity of electric charge (L-N,N-PE)	Q	12.5As, 25As	12.5As, 25As	12.5As, 25As
Specific energy (L-N,N-PE)	W/R	156kJ/Ω, 625kJ/Ω	156kJ/Ω, 625kJ/Ω	156kJ/Ω, 625kJ/Ω
Voltage protection level	U _p (L-N/N-PE)	≤2.0kV/≤1.5kV	≤2.0kV/≤1.5kV	≤2.0kV/≤1.5kV
Short-circuit current rating a.c.	I _{SCCR} (L-N/N-PE)	25kA rms/100A rms	25kA rms/100A rms	25kA rms/100A rms
Max. backup fuse		315A gG	315A gG	315A gG
Temporary overvoltage	TOV (L-N)	230V/120min-withstand	440V/120min-withstand	520V/120min-withstand
Temporary overvoltage	TOV (N-PE)	1200V/200ms-withstand	1200V/200ms-withstand	1200V/200ms-withstand
Response time	t _A	≤100ns	≤100ns	≤100ns
Operating temperature range	T _u	-40°C-80°C	-40°C-80°C	-40°C-80°C
Cross-section area (Min.)		4mm ²	4mm ²	4mm ²
Cross-section area(Max.)		35mm ²	35mm ²	35mm ²
For mounting on		35mm Din rail	35mm Din rail	35mm Din rail
Enclosure material		Thermoplastic UL94-V0	Thermoplastic UL94-V0	Thermoplastic UL94-V0
Degree of protection		IP20	IP20	IP20
Order Code		B7130	B7143	B7156
Order Code (With remote signaling)		B7131	B7144	B7157

BR-25M 4P

Type 1+Type 2+Type 3
Surge Arrester

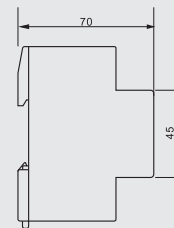
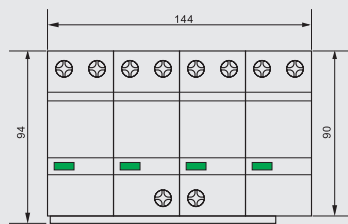
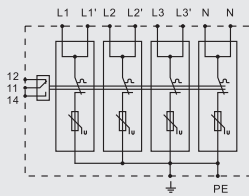

BR-25M 4P is suitable for TN-S system.

	BR-25M 150 4P	BR-25M 275 4P	BR-25M 320 4P
SPD classification according to EN61643-11	Type 1 + Type 2 + Type 3	Type 1 + Type 2 + Type 3	Type 1 + Type 2 + Type 3
SPD classification according to IEC61643-11	Class I + Class II + Class III	Class I + Class II + Class III	Class I + Class II + Class III
Max. continuous operating a.c. voltage	Uc	150V (50/60Hz)	275V (50/60Hz)
Lightning impulse current (10/350µs)	Iimp	25kA	25kA
Nominal discharge current (8/20µs)	In	25kA	25kA
Maximum discharge current (8/20µs)	I _{max}	120kA	120kA
Quantity of electric charge	Q	12.5As	12.5As
Specific energy	W/R	156kJ/Ω	156kJ/Ω
Voltage protection level	Up	≤0.8kV	≤1.3kV
Short-circuit current rating a.c.	I _{sc}	25kA rms	25kA rms
Max. backup fuse		200A gG	200A gG
Temporary overvoltage	TOV	180V/5s-withstand	335V/5s-withstand
Temporary overvoltage	TOV	230V/120min-safe failure	440V/120min-safe failure
Response time	t _a	≤25ns	≤25ns
Operating temperature range	T _u	-40°C-80°C	-40°C-80°C
Cross-section area (Min.)		4mm ²	4mm ²
Cross-section area(Max.)		35mm ²	35mm ²
For mounting on		35mm Din rail	35mm Din rail
Enclosure material		Thermoplastic UL94-V0	Thermoplastic UL94-V0
Degree of protection		IP20	IP20
Order Code		B7200	B7213
Order Code (With remote signaling)		B7201	B7214

BR-25M 3P

Type 1+Type 2+Type 3
Surge Arrester

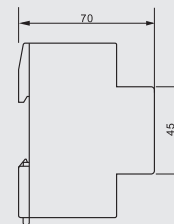
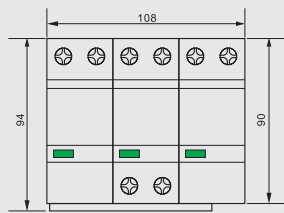
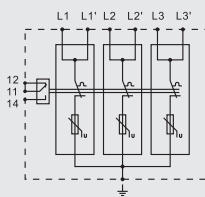

■ BR-25M 3P is suitable for TN-C system.

	BR-25M 150 3P	BR-25M 275 3P	BR-25M 320 3P
SPD classification according to EN61643-11	Type 1 + Type 2 + Type 3	Type 1 + Type 2 + Type 3	Type 1 + Type 2 + Type 3
SPD classification according to IEC61643-11	Class I + Class II + Class III	Class I + Class II + Class III	Class I + Class II + Class III
Max. continuous operating a.c. voltage	Uc	150V (50/60Hz)	275V (50/60Hz)
Lightning impulse current (10/350µs)	Iimp	25kA	25kA
Nominal discharge current (8/20µs)	In	25kA	25kA
Maximum discharge current (8/20µs)	I _{max}	120kA	120kA
Quantity of electric charge	Q	12.5As	12.5As
Specific energy	W/R	156kJ/Ω	156kJ/Ω
Voltage protection level	Up	≤0.8kV	≤1.3kV
Short-circuit current rating a.c.	I _{sc}	25kA rms	25kA rms
Max. backup fuse		200A gG	200A gG
Temporary overvoltage	TOV	180V/5s-withstand	335V/5s -withstand
Temporary overvoltage	TOV	230V/120min-safe failure	440V/120min-safe failure
Response time	t _a	≤25ns	≤25ns
Operating temperature range	T _u	-40°C-80°C	-40°C-80°C
Cross-section area (Min.)		4mm ²	4mm ²
Cross-section area(Max.)		35mm ²	35mm ²
For mounting on		35mm Din rail	35mm Din rail
Enclosure material		Thermoplastic UL94-V0	Thermoplastic UL94-V0
Degree of protection		IP20	IP20
Order Code		B7202	B7215
Order Code (With remote signaling)		B7203	B7216

BR-25M 2P

Type 1+Type 2+Type 3
Surge Arrester

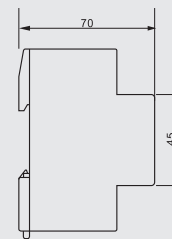
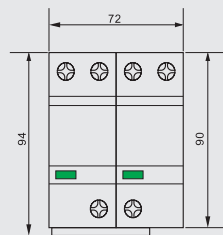
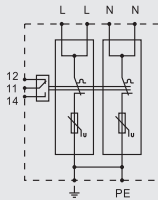

■ BR-25M 2P surge arrester is suitable for single phase TN system.

	BR-25M 150 2P	BR-25M 275 2P	BR-25M 320 2P
SPD classification according to EN61643-11	Type 1 + Type 2 + Type 3	Type 1 + Type 2 + Type 3	Type 1 + Type 2 + Type 3
SPD classification according to IEC61643-11	Class I + Class II + Class III	Class I + Class II + Class III	Class I + Class II + Class III
Max. continuous operating a.c. voltage	Uc	150V (50/60Hz)	275V (50/60Hz)
Lightning impulse current (10/350µs)	Iimp	25kA	25kA
Nominal discharge current (8/20µs)	In	25kA	25kA
Maximum discharge current (8/20µs)	I _{max}	120kA	120kA
Quantity of electric charge	Q	12.5As	12.5As
Specific energy	W/R	156kJ/Ω	156kJ/Ω
Voltage protection level	Up	≤ 0.8kV	≤ 1.3kV
Short-circuit current rating a.c.	I _{sc}	25kA rms	25kA rms
Max. backup fuse		200A gG	200A gG
Temporary overvoltage	TOV	180V/5s-withstand	335V/5s-withstand
Temporary overvoltage	TOV	230V/120min-safe failure	440V/120min-safe failure
Response time	t _A	≤ 25ns	≤ 25ns
Operating temperature range	T _u	-40°C-80°C	-40°C-80°C
Cross-section area (Min.)		4mm ²	4mm ²
Cross-section area(Max.)		35mm ²	35mm ²
For mounting on		35mm Din rail	35mm Din rail
Enclosure material		Thermoplastic UL94-V0	Thermoplastic UL94-V0
Degree of protection		IP20	IP20
Order Code		B7204	B7217
Order Code (With remote signaling)		B7205	B7218

BR-25M 1P

Type 1+Type 2+Type 3
Surge Arrester

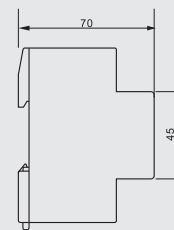
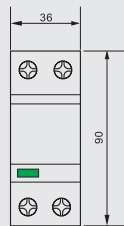
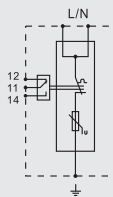

BR-25M 1P can be used to build 2P, 3P and 4P surge arresters.

	BR-25M 150 1P	BR-25M 275 1P	BR-25M 320 1P
SPD classification according to EN61643-11	Type 1 + Type 2 + Type 3	Type 1 + Type 2 + Type 3	Type 1 + Type 2 + Type 3
SPD classification according to IEC61643-11	Class I + Class II + Class III	Class I + Class II + Class III	Class I + Class II + Class III
Max. continuous operating a.c. voltage	Uc	150V (50/60Hz)	275V (50/60Hz)
Lightning impulse current (10/350µs)	Iimp	25kA	25kA
Nominal discharge current (8/20µs)	In	25kA	25kA
Maximum discharge current (8/20µs)	I _{max}	120kA	120kA
Quantity of electric charge	Q	12.5As	12.5As
Specific energy	W/R	156kJ/Ω	156kJ/Ω
Voltage protection level	Up	≤0.8kV	≤1.3kV
Short-circuit current rating a.c.	I _{sc}	25kA rms	25kA rms
Max. backup fuse		200A gG	200A gG
Temporary overvoltage	TOV	180V/5s-withstand	335V/5s -withstand
Temporary overvoltage	TOV	230V/120min-safe failure	440V/120min-safe failure
Response time	t _A	≤25ns	≤25ns
Operating temperature range	T _u	-40°C-80°C	-40°C-80°C
Cross-section area (Min.)		4mm ²	4mm ²
Cross-section area(Max.)		35mm ²	35mm ²
For mounting on		35mm Din rail	35mm Din rail
Enclosure material		Thermoplastic UL94-V0	Thermoplastic UL94-V0
Degree of protection		IP20	IP20
Order Code		B7206	B7219
Order Code (With remote signaling)		B7207	B7220

BR-25M 3+1

Type 1+Type 2+Type 3
Surge Arrester

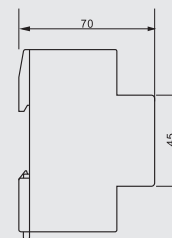
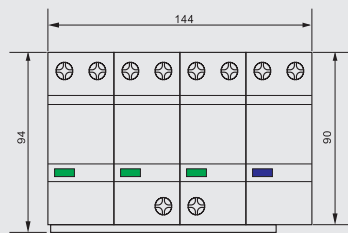
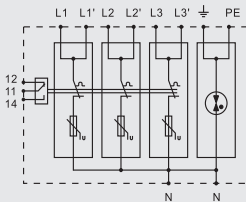

■ BR-25M 3+1 surge arrester is suitable for TT and TN-S system.

	BR-25M 150 3+1	BR-25M 275 3+1	BR-25M 320 3+1
SPD classification according to EN61643-11	Type 1 + Type 2 + Type 3	Type 1 + Type 2 + Type 3	Type 1 + Type 2 + Type 3
SPD classification according to IEC61643-11	Class I + Class II + Class III	Class I + Class II + Class III	Class I + Class II + Class III
Max. continuous operating a.c. voltage U_c (L-N/N-PE)	150V/255V (50/60Hz)	275V/255V (50/60Hz)	320V/255V (50/60Hz)
Lightning impulse current (10/350 μ s) I_{imp} (L-N/N-PE)	25kA/100kA	25kA/100kA	25kA/100kA
Nominal discharge current (8/20 μ s) I_n (L-N/N-PE)	25kA/100kA	25kA/100kA	25kA/100kA
Maximum discharge current (8/20 μ s) I_{max} (L-N/N-PE)	120kA/200kA	120kA/200kA	120kA/200kA
Quantity of electric charge (L-N,N-PE) Q	12.5As, 50As	12.5As, 50As	12.5As, 50As
Specific energy (L-N,N-PE) W/R	156kJ/ Ω , 2500kJ/ Ω	156kJ/ Ω , 2500kJ/ Ω	156kJ/ Ω , 2500kJ/ Ω
Voltage protection level U_p (L-N/N-PE)	$\leq 0.8kV/\leq 1.5kV$	$\leq 1.3kV/\leq 1.5kV$	$\leq 1.5kV/\leq 1.5kV$
Short-circuit current rating a.c. $I_{sc cr}(L-N/N-PE)$	25kA rms/100A rms	25kA rms/100A rms	25kA rms/100A rms
Max. backup fuse	200A gG	200A gG	200A gG
Temporary overvoltage TOV (L-N)	180V/5s -withstand	335V/5s -withstand	400V/5s -withstand
Temporary overvoltage TOV (L-N)	230V/120min -safe failure	440V/120min -safe failure	520V/120min -safe failure
Temporary overvoltage TOV (N-PE)	1200V/200ms -withstand	1200V/200ms -withstand	1200V/200ms -withstand
Response time t_A	$\leq 25ns/\leq 100ns$	$\leq 25ns/\leq 100ns$	$\leq 25ns/\leq 100ns$
Operating temperature range T_u	-40°C-80°C	-40°C-80°C	-40°C-80°C
Cross-section area (Min.)	4mm ²	4mm ²	4mm ²
Cross-section area(Max.)	35mm ²	35mm ²	35mm ²
For mounting on	35mm Din rail	35mm Din rail	35mm Din rail
Enclosure material	Thermoplastic UL94-V0	Thermoplastic UL94-V0	Thermoplastic UL94-V0
Degree of protection	IP20	IP20	IP20
Order Code	B7208	B8163	B7221
Order Code (With remote signaling)	B7209	B8164	B7222

BR-25M 1+1

Type 1+Type 2+Type 3
Surge Arrester

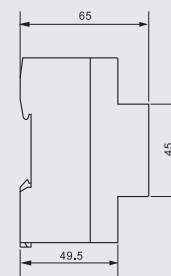
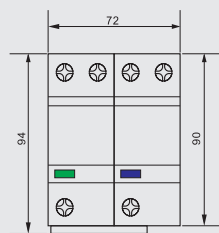
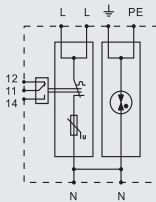

■ BR-25M 1+1 surge arrester is suitable for TT and TN-S system.

		BR-25M 150 1+1	BR-25M 275 1+1	BR-25M 320 1+1
SPD classification according to EN61643-11		Type 1 + Type 2 + Type 3	Type 1 + Type 2 + Type 3	Type 1 + Type 2 + Type 3
SPD classification according to IEC61643-11		Class I + Class II + Class III	Class I + Class II + Class III	Class I + Class II + Class III
Max. continuous operating a.c. voltage U_c (L-N/N-PE)		150V/255V (50/60Hz)	275V/255V (50/60Hz)	320V/255V (50/60Hz)
Lightning impulse current (10/350 μ s) I_{imp} (L-N/N-PE)		25kA/50kA	25kA/50kA	25kA/50kA
Nominal discharge current (8/20 μ s) I_n (L-N/N-PE)		25kA/50kA	25kA/50kA	25kA/50kA
Maximum discharge current (8/20 μ s) I_{max} (L-N/N-PE)		120kA/100kA	120kA/100kA	120kA/100kA
Quantity of electric charge (L-N,N-PE) Q		12.5As, 25As	12.5As, 25As	12.5As, 25As
Specific energy (L-N,N-PE) W/R		156kJ/ Ω , 625kJ/ Ω	156kJ/ Ω , 625kJ/ Ω	156kJ/ Ω , 625kJ/ Ω
Voltage protection level U_p (L-N/N-PE)		$\leq 0.8kV/\leq 1.5kV$	$\leq 1.3kV/\leq 1.5kV$	$\leq 1.5kV/\leq 1.5kV$
Short-circuit current rating a.c. I_{scCR} (L-N/N-PE)		25kA rms/100A rms	25kA rms/100A rms	25kA rms/100A rms
Max. backup fuse		200A gG	200A gG	200A gG
Temporary overvoltage TOV (L-N)		180V/5s-withstand	335V/5s -withstand	400V/5s-withstand
Temporary overvoltage TOV (L-N)		230V/120min-safe failure	440V/120min-safe failure	520V/120min-safe failure
Temporary overvoltage TOV (N-PE)		1200V/200ms -withstand	1200V/200ms -withstand	1200V/200ms -withstand
Response time t_A		$\leq 25ns/\leq 100ns$	$\leq 25ns/\leq 100ns$	$\leq 25ns/\leq 100ns$
Operating temperature range T_u		-40°C-80°C	-40°C-80°C	-40°C-80°C
Cross-section area (Min.)		4mm ²	4mm ²	4mm ²
Cross-section area(Max.)		35mm ²	35mm ²	35mm ²
For mounting on		35mm Din rail	35mm Din rail	35mm Din rail
Enclosure material		Thermoplastic UL94-V0	Thermoplastic UL94-V0	Thermoplastic UL94-V0
Degree of protection		IP20	IP20	IP20
Order Code		B7210	B8153	B7223
Order Code (With remote signaling)		B7211	B8154	B7224

BR-25GRS 3+1 Type 1 Surge Arrester

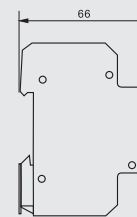
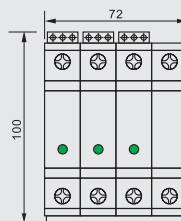
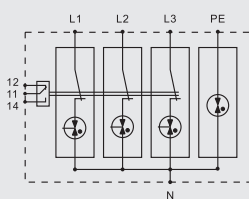

BR-25GRS 3+1 surge arrester is suitable for TT and TN-S system

		BR-25GRS 150 3+1	BR-25GRS 275 3+1	BR-25GRS 320 3+1
SPD classification according to EN61643-11		Type 1 + Type 2	Type 1 + Type 2	Type 1 + Type 2
SPD classification according to IEC61643-11		Class I + Class II	Class I + Class II	Class I + Class II
Max. continuous operating a.c. voltage	Uc (L-N/N-PE)	150V/255V (50/60Hz)	275V/255V (50/60Hz)	320V/255V (50/60Hz)
Lightning impulse current (10/350µs)	Iimp (L-N/N-PE)	25kA/100kA	25kA/100kA	25kA/100kA
Nominal discharge current (8/20µs)	In (L-N/N-PE)	25kA/100kA	25kA/100kA	25kA/100kA
Maximum discharge current (8/20µs)	I _{max} (L-N/N-PE)	50kA/160kA	50kA/160kA	50kA/160kA
Quantity of electric charge (L-N,N-PE)	Q	12.5As, 50As	12.5As, 50As	12.5As, 50As
Specific energy (L-N,N-PE)	W/R (L-N/N-PE)	156kJ/Ω, 2500kJ/Ω	156kJ/Ω, 2500kJ/Ω	156kJ/Ω, 2500kJ/Ω
Voltage protection level	Up (L-N/N-PE)	≤2.3kV/≤1.5kV	≤2.3kV/≤1.5kV	≤2.3kV/≤1.5kV
Short-circuit current rating a.c.	I _{scCR} (L-N/N-PE)	25kA rms/100A rms	25kA rms/100A rms	25kA rms/100A rms
Max. backup fuse		250A gG	250A gG	250A gG
Temporary overvoltage	TOV (L-N)	230V/120min-withstand	440V/120min-withstand	520V/120min-withstand
Temporary overvoltage	TOV (N-PE)	1200V/200ms-withstand	1200V/200ms-withstand	1200V/200ms-withstand
Response time	t _A	≤100ns	≤100ns	≤100ns
Operating temperature range	T _u	-40°C-80°C	-40°C-80°C	-40°C-80°C
Cross-section area (Min.)		4mm ²	4mm ²	4mm ²
Cross-section area (Max.)		35mm ²	35mm ²	35mm ²
For mounting on		35mm Din rail	35mm Din rail	35mm Din rail
Enclosure material		Thermoplastic UL94-V0	Thermoplastic UL94-V0	Thermoplastic UL94-V0
Degree of protection		IP20	IP20	IP20
Order Code		B7058	B7071	B7084
Order Code (With remote signaling)		B7059	B7072	B7085

BR-25GRS 1+1 Type 1 Surge Arrester

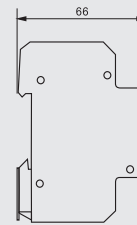
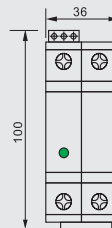
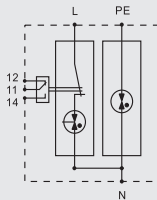

■ BR-25GRS 1+1 surge arrester is suitable for TT and TN-S system

		BR-25GRS 150 1+1	BR-25GRS 275 1+1	BR-25GRS 320 1+1
SPD classification according to EN61643-11		Type 1 + Type 2	Type 1 + Type 2	Type 1 + Type 2
SPD classification according to IEC61643-11		Class I + Class II	Class I + Class II	Class I + Class II
Max. continuous operating a.c. voltage	Uc (L-N/N-PE)	150V/255V (50/60Hz)	275V/255V (50/60Hz)	320V/255V (50/60Hz)
Lightning impulse current (10/350µs)	Iimp (L-N/N-PE)	25kA/50kA	25kA/50kA	25kA/50kA
Nominal discharge current (8/20µs)	In (L-N/N-PE)	25kA/50kA	25kA/50kA	25kA/50kA
Maximum discharge current (8/20µs)	I _{max} (L-N/N-PE)	50kA/100kA	50kA/100kA	50kA/100kA
Quantity of electric charge (L-N,N-PE)	Q	12.5As, 25As	12.5As, 25As	12.5As, 25As
Specific energy (L-N,N-PE)	W/R (L-N/N-PE)	156kJ/Ω, 625kJ/Ω	156kJ/Ω, 625kJ/Ω	156kJ/Ω, 625kJ/Ω
Voltage protection level	Up (L-N/N-PE)	≤2.3kV/≤1.5kV	≤2.3kV/≤1.5kV	≤2.3kV/≤1.5kV
Short-circuit current rating a.c.	I _{sc} (L-N/N-PE)	25kA rms/100A rms	25kA rms/100A rms	25kA rms/100A rms
Max. backup fuse		250A gG	250A gG	250A gG
Temporary overvoltage	TOV (L-N)	230V/120min-withstand	440V/120min-withstand	520V/120min-withstand
Temporary overvoltage	TOV (N-PE)	1200V/200ms-withstand	1200V/200ms-withstand	1200V/200ms-withstand
Response time	t _A	≤100ns	≤100ns	≤100ns
Operating temperature range	T _u	-40°C-80°C	-40°C-80°C	-40°C-80°C
Cross-section area (Min.)		4mm ²	4mm ²	4mm ²
Cross-section area (Max.)		35mm ²	35mm ²	35mm ²
For mounting on		35mm Din rail	35mm Din rail	35mm Din rail
Enclosure material		Thermoplastic UL94-V0	Thermoplastic UL94-V0	Thermoplastic UL94-V0
Degree of protection		IP20	IP20	IP20
Order Code		B7060	B7073	B7086
Order Code (With remote signaling)		B7061	B7074	B7087

B+C
Surge Arrester



T1+T2 Surge Arrester

www.britecelectric.com

BR-12.5M 4P

T1+T2 Surge Arrester

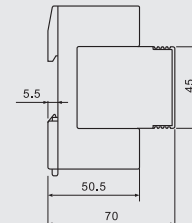
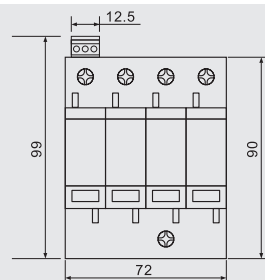
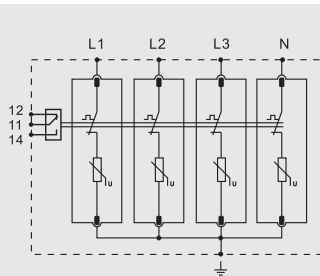
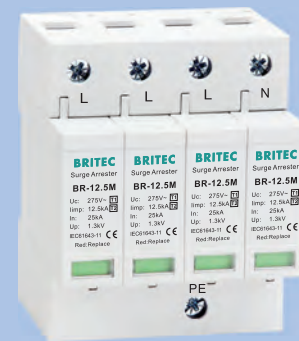

■ BR-12.5M 4P surge arrester is suitable for TN-S system.

	BR-12.5M 150 4P	BR-12.5M 275 4P	BR-12.5M 320 4P
SPD classification according to EN61643-11	Type 1 + Type 2	Type 1 + Type 2	Type 1 + Type 2
SPD classification according to IEC61643-11	Class I + Class II	Class I + Class II	Class I + Class II
Max. continuous operating a.c. voltage U_c	150V	275V	320V
Lightning impulse current (10/350 μ s) I_{imp}	12.5kA	12.5kA	12.5kA
Nominal discharge current (8/20 μ s) I_n	25kA	25kA	25kA
Max. discharge current (8/20 μ s) I_{max}	60kA	60kA	60kA
Voltage protection level U_p	$\leq 1.0kV$	$\leq 1.3kV$	$\leq 1.5kV$
Specific energy W/R	39kJ/ Ω	39kJ/ Ω	39kJ/ Ω
Short circuit withstand capacity $I_{sc cr}$	25kA	25kA	25kA
Temporary overvoltage TOV-withstand U_T	180V/5sec.	335V/5sec.	400V/5sec.
Temporary overvoltage TOV-safe failure U_T	230V/120min.	440V/120min.	520V/120min.
Max. backup fuse	125A gG	125A gG	125A gG
Response time t_A	$\leq 25ns$	$\leq 25ns$	$\leq 25ns$
Operating temperature range T_u	-40°C-80°C	-40°C-80°C	-40°C-80°C
Operating state/fault indication	green/red	green/red	green/red
Cross-section area (Min.)	4mm ²	4mm ²	4mm ²
Cross-section area (Max.)	35mm ²	35mm ²	35mm ²
For mounting on	35mm Din rail		
Enclosure material	Thermoplastic UL94-V0		
Degree of protection	IP20	IP20	IP20
Order Code	B8411	B8413	B8415
Order Code (With remote signaling)	B8412	B8414	B8416

BR-12.5M 3P

T1+T2 Surge Arrester

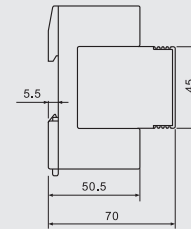
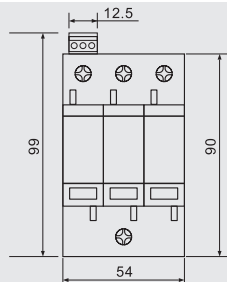
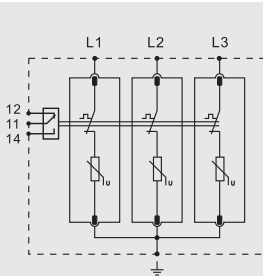
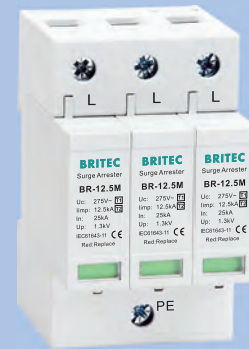

■ BR-12.5M 3P surge arrester is suitable for TN-C system.

		BR-12.5M 150 3P	BR-12.5M 275 3P	BR-12.5M 320 3P
SPD classification according to EN61643-11		Type 1 + Type 2	Type 1 + Type 2	Type 1 + Type 2
SPD classification according to IEC61643-11		Class I + Class II	Class I + Class II	Class I + Class II
Max. continuous operating a.c. voltage	Uc	150V	275V	320V
Lightning impulse current (10/350µs)	Iimp	12.5kA	12.5kA	12.5kA
Nominal discharge current (8/20µs)	In	25kA	25kA	25kA
Max. discharge current (8/20µs)	I _{max}	60kA	60kA	60kA
Voltage protection level	Up	≤1.0kV	≤1.3kV	≤1.5kV
Specific energy	W/R	39kJ/Ω	39kJ/Ω	39kJ/Ω
Short circuit withstand capacity	I _{scrr}	25kA	25kA	25kA
Temporary overvoltage TOV-withstand	U _T	180V/5sec.	335V/5sec.	400V/5sec.
Temporary overvoltage TOV-safe failure	U _T	230V/120min.	440V/120min.	520V/120min.
Max. backup fuse		125A gG	125A gG	125A gG
Response time	t _A	≤25ns	≤25ns	≤25ns
Operating temperature range	T _u	-40°C–80°C	-40°C–80°C	-40°C–80°C
Operating state/fault indication		green/red	green/red	green/red
Cross-section area (Min.)		4mm ²	4mm ²	4mm ²
Cross-section area (Max.)		35mm ²	35mm ²	35mm ²
For mounting on		35mm Din rail		
Enclosure material		Thermoplastic UL94-V0		
Degree of protection		IP20	IP20	IP20
Order Code		B8311	B8313	B8315
Order Code (With remote signaling)		B8312	B8314	B8316

BR-12.5M 2P

T1+T2 Surge Arrester

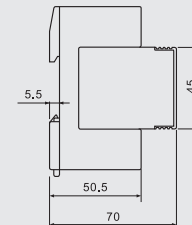
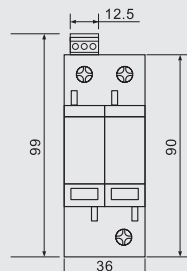
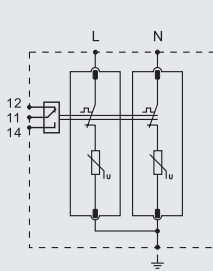
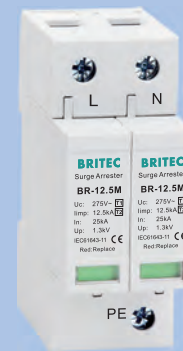

BR-12.5M 2P surge arrester is suitable for single phase TN system.

	BR-12.5M 150 2P	BR-12.5M 275 2P	BR-12.5M 320 2P
SPD classification according to EN61643-11	Type 1 + Type 2	Type 1 + Type 2	Type 1 + Type 2
SPD classification according to IEC61643-11	Class I + Class II	Class I + Class II	Class I + Class II
Max. continuous operating a.c. voltage	Uc	150V	275V
Lightning impulse current (10/350µs)	Iimp	12.5kA	12.5kA
Nominal discharge current (8/20µs)	In	25kA	25kA
Max. discharge current (8/20µs)	I _{max}	60kA	60kA
Voltage protection level	Up	≤1.0kV	≤1.3kV
Specific energy	W/R	39kJ/Ω	39kJ/Ω
Short circuit withstand capacity	I _{sc}	25kA	25kA
Temporary overvoltage TOV-withstand	U _T	180V/5sec.	335V/5sec.
Temporary overvoltage TOV-safe failure	U _T	230V/120min.	440V/120min.
Max. backup fuse		125A gG	125A gG
Response time	t _A	≤25ns	≤25ns
Operating temperature range	T _u	-40°C-80°C	-40°C-80°C
Operating state/fault indication		green/red	green/red
Cross-section area (Min.)		4mm ²	4mm ²
Cross-section area (Max.)		35mm ²	35mm ²
For mounting on	35mm Din rail		
Enclosure material	Thermoplastic UL94-V0		
Degree of protection	IP20	IP20	IP20
Order Code	B8211	B8213	B8215
Order Code (With remote signaling)	B8212	B8214	B8216

BR-12.5M 1P

T1+T2 Surge Arrester

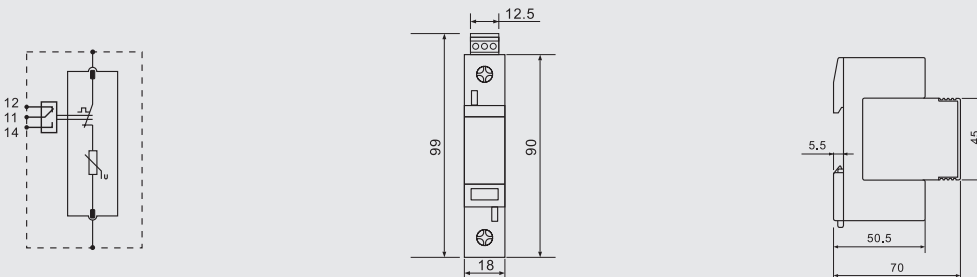

■ BR-12.5M 1P can be used to build 2P, 3P and 4P surge arresters.

	BR-12.5M 150 1P	BR-12.5M 275 1P	BR-12.5M 320 1P
SPD classification according to EN61643-11	Type 1 + Type 2	Type 1 + Type 2	Type 1 + Type 2
SPD classification according to IEC61643-11	Class I + Class II	Class I + Class II	Class I + Class II
Max. continuous operating a.c. voltage	U_c	150V	275V
Lightning impulse current (10/350 μ s)	I_{imp}	12.5kA	12.5kA
Nominal discharge current (8/20 μ s)	I_n	25kA	25kA
Max. discharge current (8/20 μ s)	I_{max}	60kA	60kA
Voltage protection level	U_p	$\leq 1.0kV$	$\leq 1.3kV$
Specific energy	W/R	39kJ/ Ω	39kJ/ Ω
Short circuit withstand capacity	I_{scrr}	25kA	25kA
Temporary overvoltage TOV-withstand	U_T	180V/5sec.	335V/5sec.
Temporary overvoltage TOV-safe failure	U_T	230V/120min.	440V/120min.
Max. backup fuse		125A gG	125A gG
Response time	t_A	$\leq 25ns$	$\leq 25ns$
Operating temperature range	T_u	-40 $^{\circ}C$ -80 $^{\circ}C$	-40 $^{\circ}C$ -80 $^{\circ}C$
Operating state/fault indication		green/red	green/red
Cross-section area (Min.)		4mm ²	4mm ²
Cross-section area (Max.)		35mm ²	35mm ²
For mounting on	35mm Din rail		
Enclosure material	Thermoplastic UL94-V0		
Degree of protection	IP20	IP20	IP20
Order Code	B8171	B8173	B8175
Order Code (With remote signaling)	B8172	B8174	B8176

BR-12.5M 3+1

T1+T2 Surge Arrester

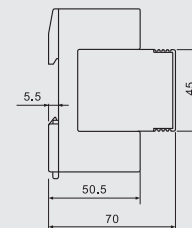
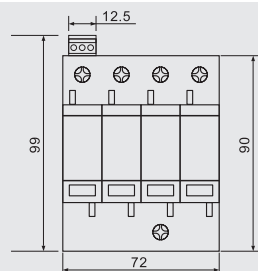
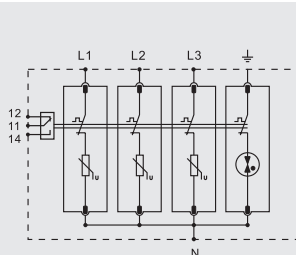
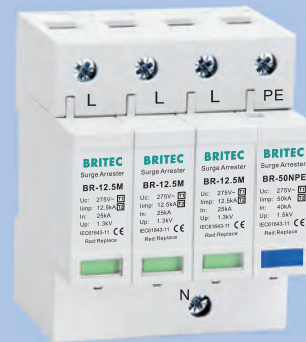

■ BR-12.5M 3+1 surge arrester is suitable for TT and TN-S system.

	BR-12.5M 150 3+1	BR-12.5M 275 3+1	BR-12.5M 320 3+1
SPD classification according to EN61643-11	Type 1 + Type 2	Type 1 + Type 2	Type 1 + Type 2
SPD classification according to IEC61643-11	Class I + Class II	Class I + Class II	Class I + Class II
Max. continuous operating a.c. voltage U_c	150V	275V	320V
Lightning impulse current (10/350 μ s) (L-N/N-PE) I_{imp}	12.5kA/50kA	12.5kA/50kA	12.5kA/50kA
Nominal discharge current (8/20 μ s) (L-N/N-PE) I_n	25kA/50kA	25kA/50kA	25kA/50kA
Max. discharge current (8/20 μ s) (L-N/N-PE) I_{max}	60kA/100kA	60kA/100kA	60kA/100kA
Voltage protection level (L-N/N-PE) U_p	$\leq 1.0kV/\leq 1.5kV$	$\leq 1.3kV/\leq 1.5kV$	$\leq 1.5kV/\leq 1.5kV$
Voltage protection level 5kA (L-N/N-PE) U_p	$\leq 0.6kV/\leq 1.5kV$	$\leq 1kV/\leq 1.5kV$	$\leq 1.2kV/\leq 1.5kV$
Max. backup fuse	125A gG	125A gG	125A gG
Specific energy (L-N/N-PE) W/R	39kJ/ Ω / 625kJ/ Ω	39kJ/ Ω / 625kJ/ Ω	39kJ/ Ω / 625kJ/ Ω
Short circuit withstand capacity I_{scrr}	25kA	25kA	25kA
Temporary overvoltage TOV-withstand (L-N) U_T	180V/5sec.	335V/5sec.	400V/5sec.
Temporary overvoltage TOV-safe failure (L-N) U_T	230V/120min.	440V/120min.	520V/120min.
Temporary overvoltage TOV-withstand (N-PE) U_T	1200V/200ms	1200V/200ms	1200V/200ms
Response time (L-N/N-PE) t_A	$\leq 25ns/\leq 100ns$	$\leq 25ns/\leq 100ns$	$\leq 25ns/\leq 100ns$
Operating temperature range T_u	-40 $^{\circ}C$ -80 $^{\circ}C$	-40 $^{\circ}C$ -80 $^{\circ}C$	-40 $^{\circ}C$ -80 $^{\circ}C$
Operating state/fault indication	green/red	green/red	green/red
Cross-section area (Min.)	4 mm ²	4 mm ²	4 mm ²
Cross-section area (Max.)	35mm ²	35mm ²	35mm ²
For mounting on	35mm Din rail		
Enclosure material	Thermoplastic UL94-V0		
Degree of protection	IP20	IP20	IP20
Order Code	B8611	B8613	B8615
Order Code (With remote signaling)	B8612	B8614	B8616

BR-12.5M 1+1

T1+T2 Surge Arrester

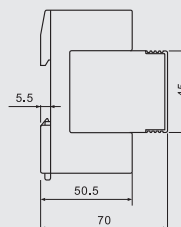
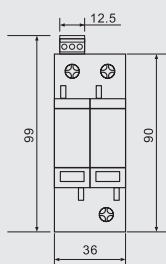
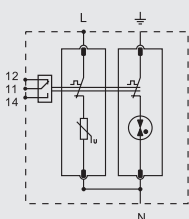

BR-12.5M 1+1 surge arrester is suitable for TT and TN-S system.

	BR-12.5M 150 1+1	BR-12.5M 275 1+1	BR-12.5M 320 1+1
SPD classification according to EN61643-11	Type 1 + Type 2	Type 1 + Type 2	Type 1 + Type 2
SPD classification according to IEC61643-11	Class I + Class II	Class I + Class II	Class I + Class II
Max. continuous operating a.c. voltage U _c	150V	275V	320V
Lightning impulse current (10/350μs) (L-N/N-PE) I _{imp}	12.5kA/25kA	12.5kA/25kA	12.5kA/25kA
Nominal discharge current (8/20μs) (L-N/N-PE) I _n	25kA/40kA	25kA/40kA	25kA/40kA
Max. discharge current (8/20μs) (L-N/N-PE) I _{max}	60kA/80kA	60kA/80kA	60kA/80kA
Voltage protection level (L-N/N-PE) U _p	≤1.0kV/≤1.5kV	≤1.3kV/≤1.5kV	≤1.5kV/≤1.5kV
Voltage protection level 5kA (L-N/N-PE) U _p	≤0.6kV/≤1.5kV	≤1kV/≤1.5kV	≤1.2kV/≤1.5kV
Max. backup fuse	125A gG	125A gG	125A gG
Specific energy (L-N/N-PE) W/R	39kJ/Ω / 156kJ/Ω	39kJ/Ω / 156kJ/Ω	39kJ/Ω / 156kJ/Ω
Short circuit withstand capacity I _{scrr}	25kA	25kA	25kA
Temporary overvoltage TOV-withstand (L-N) U _T	180V/5sec.	335V/5sec.	400V/5sec.
Temporary overvoltage TOV-safe failure (L-N) U _T	230V/120min.	440V/120min.	520V/120min.
Temporary overvoltage TOV-withstand (N-PE) U _T	1200V/200ms	1200V/200ms	1200V/200ms
Response time (L-N/N-PE) t _A	≤25ns/≤100ns	≤25ns/≤100ns	≤25ns/≤100ns
Operating temperature range T _u	-40°C-80°C	-40°C-80°C	-40°C-80°C
Operating state/fault indication	green/red	green/red	green/red
Cross-section area (Min.)	4 mm ²	4 mm ²	4 mm ²
Cross-section area (Max.)	35mm ²	35mm ²	35mm ²
For mounting on	35mm Din rail		
Enclosure material	Thermoplastic UL94-V0		
Degree of protection	IP20	IP20	IP20
Order Code	B8617	B8619	B8621
Order Code (With remote signaling)	B8618	B8620	B8622

BR-7M 4P

T1+T2 Surge Arrester

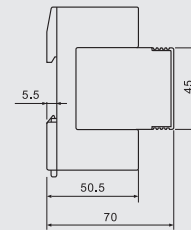
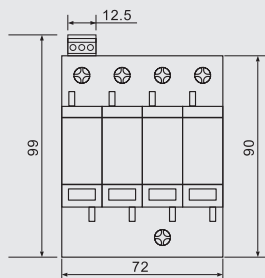
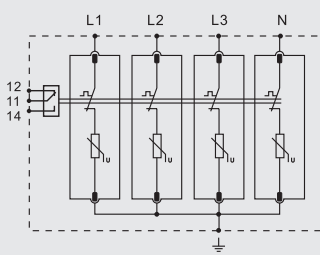
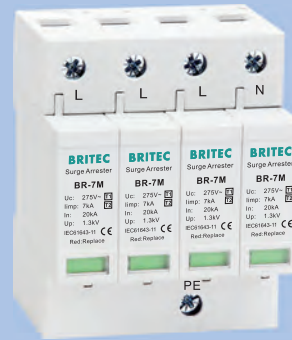

■ BR-7M 4P surge arrester is suitable for TN-S system.

	BR-7M 150 4P	BR-7M 275 4P	BR-7M 320 4P
SPD classification according to EN61643-11	Type 1 + Type 2	Type 1 + Type 2	Type 1 + Type 2
SPD classification according to IEC61643-11	Class I + Class II	Class I + Class II	Class I + Class II
Max. continuous operating a.c. voltage	Uc	150V	275V
Lightning impulse current (10/350µs)	Iimp	7kA	7kA
Nominal discharge current (8/20µs)	In	20kA	20kA
Max. discharge current (8/20µs)	I _{max}	50kA	50kA
Voltage protection level	Up	≤0.8kV	≤1.3kV
Specific energy	W/R	12.25kJ/Ω	12.25kJ/Ω
Short circuit withstand capacity	I _{scrr}	25kA	25kA
Temporary overvoltage TOV-withstand	U _T	180V/5sec.	335V/5sec.
Temporary overvoltage TOV-safe failure	U _T	230V/120min.	440V/120min.
Max. backup fuse		125A gG	125A gG
Response time	t _A	≤25ns	≤25ns
Operating temperature range	T _u	-40°C-80°C	-40°C-80°C
Operating state/fault indication		green/red	green/red
Cross-section area (Min.)		4mm ²	4mm ²
Cross-section area (Max.)		35mm ²	35mm ²
For mounting on	35mm Din rail		
Enclosure material	Thermoplastic UL94-V0		
Degree of protection	IP20	IP20	IP20
Order Code	B7300	B7302	B7304
Order Code (With remote signaling)	B7301	B7303	B7305

BR-7M 3P

T1+T2 Surge Arrester

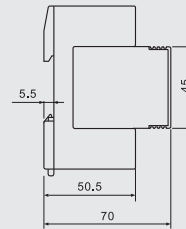
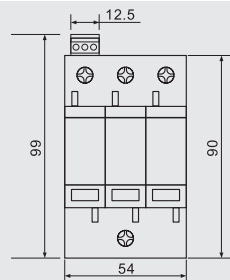
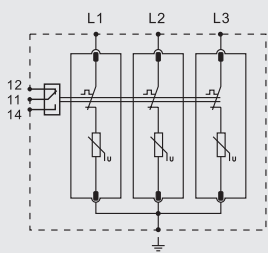

■ BR-7M 3P surge arrester is suitable for TN-C system.

	BR-7M 150 3P	BR-7M 275 3P	BR-7M 320 3P
SPD classification according to EN61643-11	Type 1 + Type 2	Type 1 + Type 2	Type 1 + Type 2
SPD classification according to IEC61643-11	Class I + Class II	Class I + Class II	Class I + Class II
Max. continuous operating a.c. voltage	Uc	150V	275V
Lightning impulse current (10/350µs)	Iimp	7kA	7kA
Nominal discharge current (8/20µs)	In	20kA	20kA
Max. discharge current (8/20µs)	I _{max}	50kA	50kA
Voltage protection level	Up	≤0.8kV	≤1.3kV
Specific energy	W/R	12.25kJ/Ω	12.25kJ/Ω
Short circuit withstand capacity	I _{scrr}	25kA	25kA
Temporary overvoltage TOV-withstand	U _T	180V/5sec.	335V/5sec.
Temporary overvoltage TOV-safe failure	U _T	230V/120min.	440V/120min.
Max. backup fuse		125A gG	125A gG
Response time	t _A	≤25ns	≤25ns
Operating temperature range	T _u	-40°C-80°C	-40°C-80°C
Operating state/fault indication		green/red	green/red
Cross-section area (Min.)		4mm ²	4mm ²
Cross-section area (Max.)		35mm ²	35mm ²
For mounting on	35mm Din rail		
Enclosure material	Thermoplastic UL94-V0		
Degree of protection	IP20	IP20	IP20
Order Code	B7306	B7308	B7310
Order Code (With remote signaling)	B7307	B7309	B7311

BR-7M 2P

T1+T2 Surge Arrester

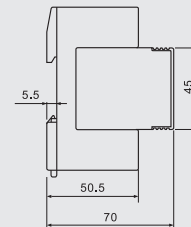
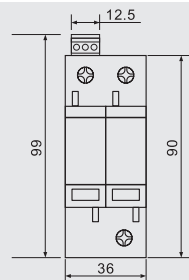
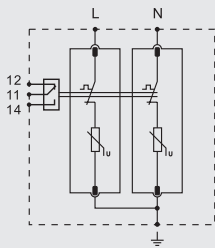

■ BR-7M 2P surge arrester is suitable for single phase TN system.

	BR-7M 150 2P	BR-7M 275 2P	BR-7M 320 2P
SPD classification according to EN61643-11	Type 1 + Type 2	Type 1 + Type 2	Type 1 + Type 2
SPD classification according to IEC61643-11	Class I + Class II	Class I + Class II	Class I + Class II
Max. continuous operating a.c. voltage	Uc	150V	275V
Lightning impulse current (10/350µs)	Iimp	7kA	7kA
Nominal discharge current (8/20µs)	In	20kA	20kA
Max. discharge current (8/20µs)	I _{max}	50kA	50kA
Voltage protection level	Up	≤0.8kV	≤1.3kV
Specific energy	W/R	12.25kJ/Ω	12.25kJ/Ω
Short circuit withstand capacity	I _{sc}	25kA	25kA
Temporary overvoltage TOV-withstand	U _T	180V/5sec.	335V/5sec.
Temporary overvoltage TOV-safe failure	U _T	230V/120min.	440V/120min.
Max. backup fuse		125A gG	125A gG
Response time	t _A	≤25ns	≤25ns
Operating temperature range	T _u	-40°C–80°C	-40°C–80°C
Operating state/fault indication		green/red	green/red
Cross-section area (Min.)		4mm ²	4mm ²
Cross-section area (Max.)		35mm ²	35mm ²
For mounting on	35mm Din rail		
Enclosure material	Thermoplastic UL94-V0		
Degree of protection	IP20	IP20	IP20
Order Code	B7312	B7314	B7316
Order Code (With remote signaling)	B7313	B7315	B7317

BR-7M 1P

T1+T2 Surge Arrester

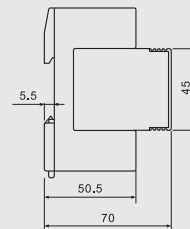
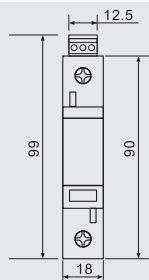
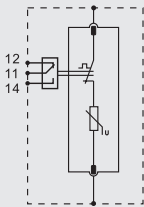

■ BR-7M 1P can be used to build 2P, 3P and 4P surge arresters.

	BR-7M 150 1P	BR-7M 275 1P	BR-7M 320 1P
SPD classification according to EN61643-11	Type 1 + Type 2	Type 1 + Type 2	Type 1 + Type 2
SPD classification according to IEC61643-11	Class I + Class II	Class I + Class II	Class I + Class II
Max. continuous operating a.c. voltage	Uc	150V	275V
Lightning impulse current (10/350µs)	Iimp	7kA	7kA
Nominal discharge current (8/20µs)	In	20kA	20kA
Max. discharge current (8/20µs)	I _{max}	50kA	50kA
Voltage protection level	Up	≤0.8kV	≤1.3kV
Specific energy	W/R	12.25kJ/Ω	12.25kJ/Ω
Short circuit withstand capacity	I _{scrr}	25kA	25kA
Temporary overvoltage TOV-withstand	U _T	180V/5sec.	335V/5sec.
Temporary overvoltage TOV-safe failure	U _T	230V/120min.	440V/120min.
Max. backup fuse		125A gG	125A gG
Response time	t _A	≤25ns	≤25ns
Operating temperature range	T _u	-40°C-80°C	-40°C-80°C
Operating state/fault indication		green/red	green/red
Cross-section area (Min.)		4mm ²	4mm ²
Cross-section area (Max.)		35mm ²	35mm ²
For mounting on	35mm Din rail		
Enclosure material	Thermoplastic UL94-V0		
Degree of protection	IP20	IP20	IP20
Order Code	B7318	B7320	B7322
Order Code (With remote signaling)	B7319	B7321	B7323

BR-7M 3+1

T1+T2 Surge Arrester

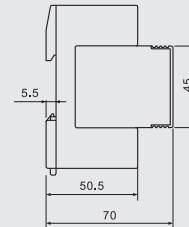
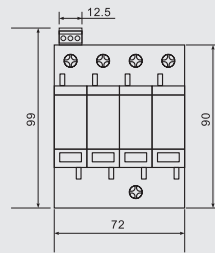
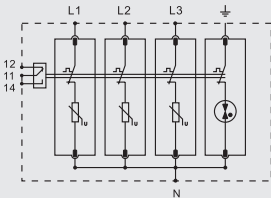
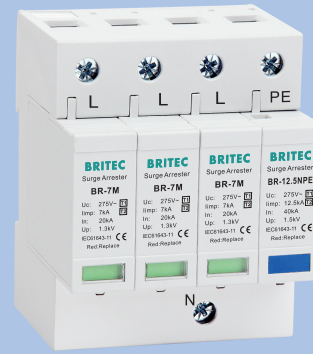

BR-7M 3+1 surge arrester is suitable for TT and TN-S system.

	BR-7M 150 3+1	BR-7M 275 3+1	BR-7M 320 3+1
SPD classification according to EN61643-11	Type 1 + Type 2	Type 1 + Type 2	Type 1 + Type 2
SPD classification according to IEC61643-11	Class I + Class II	Class I + Class II	Class I + Class II
Max. continuous operating a.c. voltage U_c	150V	275V	320V
Lightning impulse current (10/350 μ s) (L-N/N-PE) I_{imp}	7kA/12.5kA	7kA/12.5kA	7kA/12.5kA
Nominal discharge current (8/20 μ s) (L-N/N-PE) I_n	20kA/40kA	20kA/40kA	20kA/40kA
Max. discharge current (8/20 μ s) (L-N/N-PE) I_{max}	50kA/70kA	50kA/70kA	50kA/70kA
Voltage protection level (L-N/N-PE) U_p	$\leq 0.8kV/\leq 1.5kV$	$\leq 1.3kV/\leq 1.5kV$	$\leq 1.5kV/\leq 1.5kV$
Voltage protection level 5kA (L-N/N-PE) U_p	$\leq 0.6kV/\leq 1.5kV$	$\leq 1kV/\leq 1.5kV$	$\leq 1.2kV/\leq 1.5kV$
Max. backup fuse	125A gG	125A gG	125A gG
Specific energy (L-N/N-PE) W/R	12.25kJ/ Ω /39kJ/ Ω	12.25kJ/ Ω /39kJ/ Ω	12.25kJ/ Ω /39kJ/ Ω
Short circuit withstand capacity I_{scrr}	25kA	25kA	25kA
Temporary overvoltage TOV-withstand (L-N) U_T	180V/5sec.	335V/5sec.	400V/5sec.
Temporary overvoltage TOV-safe failure (L-N) U_T	230V/120min.	440V/120min.	520V/120min.
Temporary overvoltage TOV-withstand (N-PE) U_T	1200V/200ms	1200V/200ms	1200V/200ms
Response time (L-N/N-PE) t_A	$\leq 25ns/\leq 100ns$	$\leq 25ns/\leq 100ns$	$\leq 25ns/\leq 100ns$
Operating temperature range T_u	-40°C-80°C	-40°C-80°C	-40°C-80°C
Operating state/fault indication	green/red	green/red	green/red
Cross-section area (Min.)	4 mm ²	4 mm ²	4 mm ²
Cross-section area (Max.)	35mm ²	35mm ²	35mm ²
For mounting on	35mm Din rail		
Enclosure material	Thermoplastic UL94-V0		
Degree of protection	IP20	IP20	IP20
Order Code	B7324	B7326	B7328
Order Code (With remote signaling)	B7325	B7327	B7329

BR-7M 1+1

T1+T2 Surge Arrester

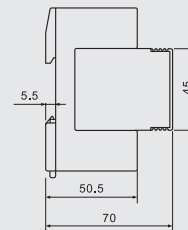
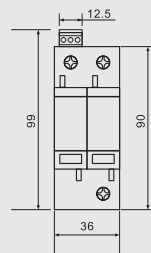
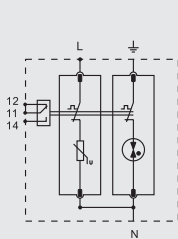
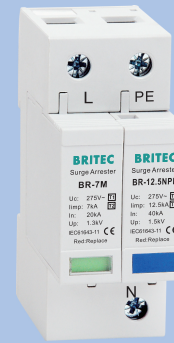

■ BR-7M 1+1 surge arrester is suitable for TT and TN-S system.

	BR-7M 150 1+1	BR-7M 275 1+1	BR-7M 320 1+1
SPD classification according to EN61643-11	Type 1 + Type 2	Type 1 + Type 2	Type 1 + Type 2
SPD classification according to IEC61643-11	Class I + Class II	Class I + Class II	Class I + Class II
Max. continuous operating a.c. voltage U_c	150V	275V	320V
Lightning impulse current (10/350 μ s) (L-N/N-PE) I_{imp}	7kA/12.5kA	7kA/12.5kA	7kA/12.5kA
Nominal discharge current (8/20 μ s) (L-N/N-PE) I_n	20kA/40kA	20kA/40kA	20kA/40kA
Max. discharge current (8/20 μ s) (L-N/N-PE) I_{max}	50kA/70kA	50kA/70kA	50kA/70kA
Voltage protection level (L-N/N-PE) U_p	$\leq 0.8kV / \leq 1.5kV$	$\leq 1.3kV / \leq 1.5kV$	$\leq 1.5kV / \leq 1.5kV$
Voltage protection level 5kA (L-N/N-PE) U_p	$\leq 0.6kV / \leq 1.5kV$	$\leq 1kV / \leq 1.5kV$	$\leq 1.2kV / \leq 1.5kV$
Max. backup fuse	125A gG	125A gG	125A gG
Specific energy (L-N/N-PE) W/R	12.25kJ/ Ω / 39kJ/ Ω	12.25kJ/ Ω / 39kJ/ Ω	12.25kJ/ Ω / 39kJ/ Ω
Short circuit withstand capacity I_{scrr}	25kA	25kA	25kA
Temporary overvoltage TOV-withstand (L-N) U_T	180V/5sec.	335V/5sec.	400V/5sec.
Temporary overvoltage TOV-safe failure (L-N) U_T	230V/120min.	440V/120min.	520V/120min.
Temporary overvoltage TOV-withstand (N-PE) U_T	1200V/200ms	1200V/200ms	1200V/200ms
Response time (L-N/N-PE) t_A	$\leq 25ns / \leq 100ns$	$\leq 25ns / \leq 100ns$	$\leq 25ns / \leq 100ns$
Operating temperature range T_u	-40 $^{\circ}C$ -80 $^{\circ}C$	-40 $^{\circ}C$ -80 $^{\circ}C$	-40 $^{\circ}C$ -80 $^{\circ}C$
Operating state/fault indication	green/red	green/red	green/red
Cross-section area (Min.)	4 mm ²	4 mm ²	4 mm ²
Cross-section area (Max.)	35mm ²	35mm ²	35mm ²
For mounting on	35mm Din rail		
Enclosure material	Thermoplastic UL94-V0		
Degree of protection	IP20	IP20	IP20
Order Code	B7330	B7332	B7334
Order Code (With remote signaling)	B7331	B7333	B7335

BR-12.5GRS 4P

T1+T2 Surge Arrester Sparkgap

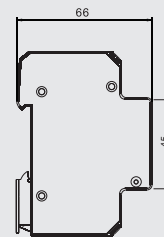
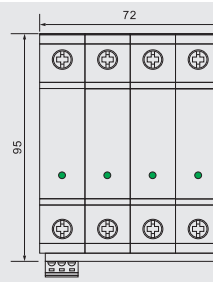
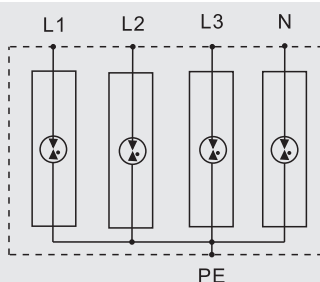

■ BR-12.5GRS 4P surge arrester is suitable for TN-S system.

	BR-12.5GRS 150 4P	BR-12.5GRS 275 4P	BR-12.5GRS 320 4P
SPD classification according to EN61643-11	Type 1 + Type 2	Type 1 + Type 2	Type 1 + Type 2
SPD classification according to IEC61643-11	Class I + Class II	Class I + Class II	Class I + Class II
Max. continuous operating a.c. voltage	Uc	150V	275V
Lightning impulse current (10/350µs)	Iimp	12.5kA	12.5kA
Nominal discharge current (8/20µs)	In	30kA	30kA
Max. discharge current (8/20µs)	I _{max}	60kA	60kA
Voltage protection level	Up	≤1.8kV	≤1.8kV
Specific energy	W/R	39kJ/Ω	39kJ/Ω
Short circuit withstand capacity	I _{sc}	25kA	25kA
Temporary overvoltage TOV-withstand	U _T	230V/120min.	440V/120min.
Max. backup fuse		160A gG	160A gG
Response time	t _a	≤25ns	≤25ns
Operating temperature range	T _u	-40°C-80°C	-40°C-80°C
Operating state/fault indication		green/off	green/off
Cross-section area (Min.)		4mm ²	4mm ²
Cross-section area (Max.)		35mm ²	35mm ²
For mounting on	35mm Din rail		
Enclosure material	Thermoplastic UL94-V0		
Degree of protection	IP20	IP20	IP20
Order Code	B7010	B7023	B7036
Order Code (With remote signaling)	B7011	B7024	B7037

BR-12.5GRS 3P

T1+T2 Surge Arrester Sparkgap

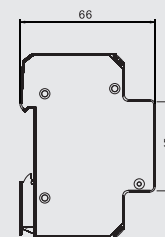
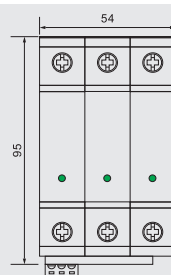
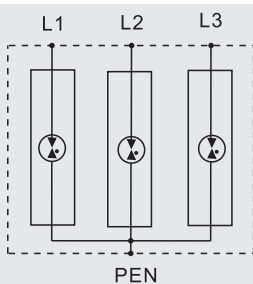
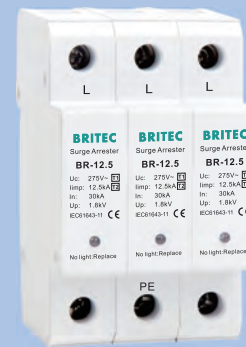

BR-12.5GRS 3P surge arrester is suitable for TN-C system.

	BR-12.5GRS 150 3P	BR-12.5GRS 275 3P	BR-12.5GRS 320 3P
SPD classification according to EN61643-11	Type 1 + Type 2	Type 1 + Type 2	Type 1 + Type 2
SPD classification according to IEC61643-11	Class I + Class II	Class I + Class II	Class I + Class II
Max. continuous operating a.c. voltage	Uc	150V	275V
Lightning impulse current (10/350µs)	Iimp	12.5kA	12.5kA
Nominal discharge current (8/20µs)	In	30kA	30kA
Max. discharge current (8/20µs)	I _{max}	60kA	60kA
Voltage protection level	Up	≤1.8kV	≤1.8kV
Specific energy	W/R	39kJ/Ω	39kJ/Ω
Short circuit withstand capacity	I _{scrr}	25kA	25kA
Temporary overvoltage TOV-withstand	U _T	230V/120min.	440V/120min.
Max. backup fuse		160A gG	160A gG
Response time	t _A	≤25ns	≤25ns
Operating temperature range	T _u	-40°C-80°C	-40°C-80°C
Operating state/fault indication		green/off	green/off
Cross-section area (Min.)		4mm ²	4mm ²
Cross-section area (Max.)		35mm ²	35mm ²
For mounting on	35mm Din rail		
Enclosure material	Thermoplastic UL94-V0		
Degree of protection	IP20	IP20	IP20
Order Code	B7012	B7025	B7038
Order Code (With remote signaling)	B7013	B7026	B7039

BR-12.5GRS 2P

T1+T2 Surge Arrester Sparkgap

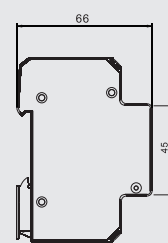
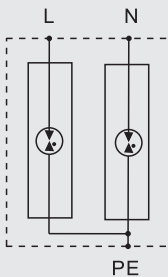
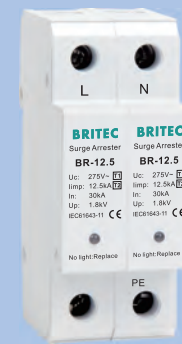

BR-12.5GRS 2P surge arrester is suitable for TN system.

	BR-12.5GRS 150 2P	BR-12.5GRS 275 2P	BR-12.5GRS 320 2P
SPD classification according to EN61643-11	Type 1 + Type 2	Type 1 + Type 2	Type 1 + Type 2
SPD classification according to IEC61643-11	Class I + Class II	Class I + Class II	Class I + Class II
Max. continuous operating a.c. voltage	U_c	150V	275V
Lightning impulse current (10/350 μ s)	I_{imp}	12.5kA	12.5kA
Nominal discharge current (8/20 μ s)	I_n	30kA	30kA
Max. discharge current (8/20 μ s)	I_{max}	60kA	60kA
Voltage protection level	U_p	$\leq 1.8kV$	$\leq 1.8kV$
Specific energy	W/R	39kJ/ Ω	39kJ/ Ω
Short circuit withstand capacity	I_{scrr}	25kA	25kA
Temporary overvoltage TOV-withstand	U_T	230V/120min.	440V/120min.
Max. backup fuse		160A gG	160A gG
Response time	t_A	$\leq 25ns$	$\leq 25ns$
Operating temperature range	T_u	-40 $^{\circ}C$ -80 $^{\circ}C$	-40 $^{\circ}C$ -80 $^{\circ}C$
Operating state/fault indication		green/off	green/off
Cross-section area (Min.)		4mm ²	4mm ²
Cross-section area (Max.)		35mm ²	35mm ²
For mounting on	35mm Din rail		
Enclosure material	Thermoplastic UL94-V0		
Degree of protection	IP20	IP20	IP20
Order Code	B7014	B7027	B7040
Order Code (With remote signaling)	B7015	B7028	B7041

BR-12.5GRS 1P

T1+T2 Surge Arrester Sparkgap

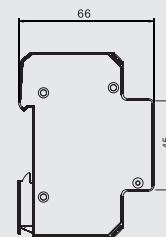
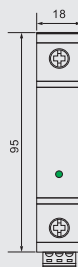
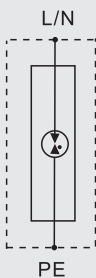

BR-12.5GRS 1P can be used to build 2P, 3P and 4P surge arresters.

	BR-12.5GRS 150 1P	BR-12.5GRS 275 1P	BR-12.5GRS 320 1P
SPD classification according to EN61643-11	Type 1 + Type 2	Type 1 + Type 2	Type 1 + Type 2
SPD classification according to IEC61643-11	Class I + Class II	Class I + Class II	Class I + Class II
Max. continuous operating a.c. voltage	Uc	150V	275V
Lightning impulse current (10/350µs)	Iimp	12.5kA	12.5kA
Nominal discharge current (8/20µs)	In	30kA	30kA
Max. discharge current (8/20µs)	I _{max}	60kA	60kA
Voltage protection level	Up	≤1.8kV	≤1.8kV
Specific energy	W/R	39kJ/Ω	39kJ/Ω
Short circuit withstand capacity	I _{scrr}	25kA	25kA
Temporary overvoltage TOV-withstand	U _T	230V/120min.	440V/120min.
Max. backup fuse		160A gG	160A gG
Response time	t _A	≤25ns	≤25ns
Operating temperature range	T _u	-40°C-80°C	-40°C-80°C
Operating state/fault indication		green/off	green/off
Cross-section area (Min.)		4mm ²	4mm ²
Cross-section area (Max.)		35mm ²	35mm ²
For mounting on	35mm Din rail		
Enclosure material	Thermoplastic UL94-V0		
Degree of protection	IP20	IP20	IP20
Order Code	B7016	B7029	B7042
Order Code (With remote signaling)	B7017	B7030	B7043

BR-12.5GRS 3+1

T1+T2 Surge Arrester

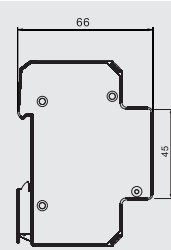
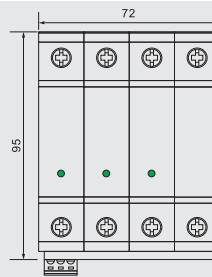
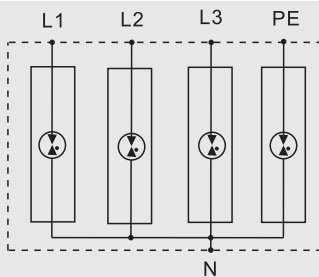
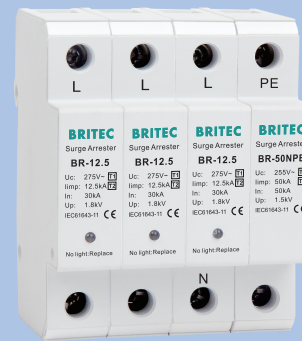

BR-12.5GRS 3+1 surge arrester is suitable for TT and TN-S system.

	BR-12.5GRS 150 3+1	BR-12.5GRS 275 3+1	BR-12.5GRS 320 3+1
SPD classification according to EN61643-11	Type 1 + Type 2	Type 1 + Type 2	Type 1 + Type 2
SPD classification according to IEC61643-11	Class I + Class II	Class I + Class II	Class I + Class II
Max. continuous operating a.c. voltage U_c	150V	275V	320V
Lightning impulse current (10/350 μ s) (L-N/N-PE) I_{imp}	12.5kA/50kA	12.5kA/50kA	12.5kA/50kA
Nominal discharge current (8/20 μ s) (L-N/N-PE) I_n	30kA/50kA	30kA/50kA	30kA/50kA
Max. discharge current (8/20 μ s) (L-N/N-PE) I_{max}	60kA/100kA	60kA/100kA	60kA/100kA
Voltage protection level (L-N/N-PE) U_p	$\leq 1.8kV / \leq 1.5kV$	$\leq 1.8kV / \leq 1.5kV$	$\leq 1.8kV / \leq 1.5kV$
Specific energy (L-N/N-PE) W/R	39kJ/ Ω / 625kJ/ Ω	39kJ/ Ω / 625kJ/ Ω	39kJ/ Ω / 625kJ/ Ω
Short circuit withstand capacity I_{scrr}	25kA	25kA	25kA
Temporary overvoltage TOV-withstand (L-N) U_T	230V/120min.	440V/120min.	520V/120min.
Temporary overvoltage TOV-withstand (N-PE) U_T	1200V/200ms	1200V/200ms	1200V/200ms
Max. backup fuse	160A gG	160A gG	160A gG
Response time (L-N/N-PE) t_A	$\leq 25ns / \leq 100ns$	$\leq 25ns / \leq 100ns$	$\leq 25ns / \leq 100ns$
Operating temperature range T_u	-40°C-80°C	-40°C-80°C	-40°C-80°C
Operating state/fault indication	green/off	green/off	green/off
Cross-section area (Min.)	4 mm ²	4 mm ²	4 mm ²
Cross-section area (Max.)	35mm ²	35mm ²	35mm ²
For mounting on	35mm Din rail		
Enclosure material	Thermoplastic UL94-V0		
Degree of protection	IP20	IP20	IP20
Order Code	B7018	B7031	B7044
Order Code (With remote signaling)	B7019	B7032	B7045

BR-12.5GRS 1+1

T1+T2 Surge Arrester

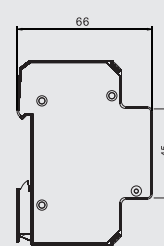
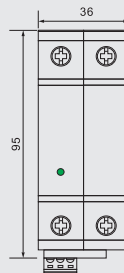
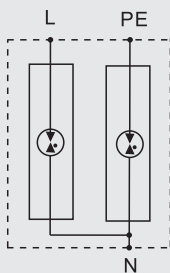
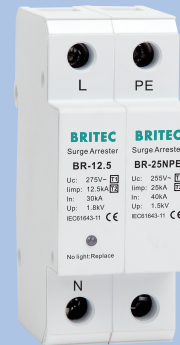

BR-12.5GRS 1+1 surge arrester is suitable for TT and TN-S system.

	BR-12.5GRS 150 1+1	BR-12.5GRS 275 1+1	BR-12.5GRS 320 1+1
SPD classification according to EN61643-11	Type 1 + Type 2	Type 1 + Type 2	Type 1 + Type 2
SPD classification according to IEC61643-11	Class I + Class II	Class I + Class II	Class I + Class II
Max. continuous operating a.c. voltage U_c	150V	275V	320V
Lightning impulse current (10/350 μ s) (L-N/N-PE) I_{imp}	12.5kA/25kA	12.5kA/25kA	12.5kA/25kA
Nominal discharge current (8/20 μ s) (L-N/N-PE) I_n	30kA/40kA	30kA/40kA	30kA/40kA
Max. discharge current (8/20 μ s) (L-N/N-PE) I_{max}	60kA/80kA	60kA/80kA	60kA/80kA
Voltage protection level (L-N/N-PE) U_p	$\leq 1.8kV / \leq 1.5kV$	$\leq 1.8kV / \leq 1.5kV$	$\leq 1.8kV / \leq 1.5kV$
Specific energy (L-N/N-PE) W/R	39kJ/ Ω / 156kJ/ Ω	39kJ/ Ω / 156kJ/ Ω	39kJ/ Ω / 156kJ/ Ω
Short circuit withstand capacity I_{sc}	25kA	25kA	25kA
Temporary overvoltage TOV-withstand (L-N) U_T	230V/120min.	440V/120min.	520V/120min.
Temporary overvoltage TOV-withstand (N-PE) U_T	1200V/200ms	1200V/200ms	1200V/200ms
Max. backup fuse	160A gG	160A gG	160A gG
Response time (L-N/N-PE) t_A	$\leq 25ns / \leq 100ns$	$\leq 25ns / \leq 100ns$	$\leq 25ns / \leq 100ns$
Operating temperature range T_u	-40 $^{\circ}C$ -80 $^{\circ}C$	-40 $^{\circ}C$ -80 $^{\circ}C$	-40 $^{\circ}C$ -80 $^{\circ}C$
Operating state/fault indication	green/off	green/off	green/off
Cross-section area (Min.)	4 mm ²	4 mm ²	4 mm ²
Cross-section area (Max.)	35mm ²	35mm ²	35mm ²
For mounting on	35mm Din rail		
Enclosure material	Thermoplastic UL94-V0		
Degree of protection	IP20	IP20	IP20
Order Code	B7020	B7033	B7046
Order Code (With remote signaling)	B7021	B7034	B7047

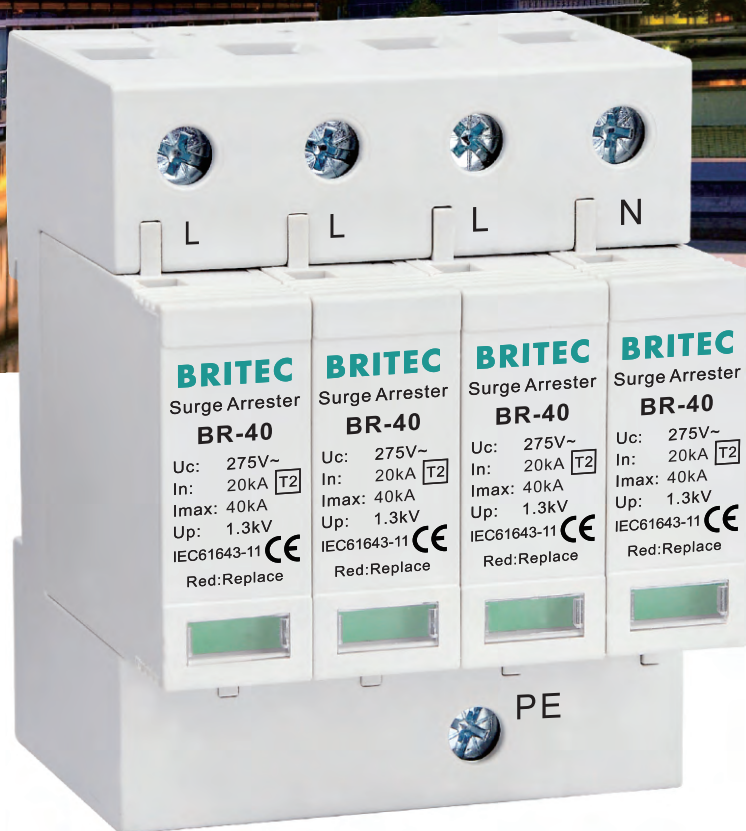

BRITEC
Surge Arrester
BR-40

Uc: 275V~
In: 20kA **T2**
Imax: 40kA
Up: 1.3kV
IEC61643-11 **CE**
Red: Replace

BRITEC
Surge Arrester
BR-40

Uc: 275V~
In: 20kA **T2**
Imax: 40kA
Up: 1.3kV
IEC61643-11 **CE**
Red: Replace

BRITEC
Surge Arrester
BR-40

Uc: 275V~
In: 20kA **T2**
Imax: 40kA
Up: 1.3kV
IEC61643-11 **CE**
Red: Replace

BRITEC
Surge Arrester
BR-40

Uc: 275V~
In: 20kA **T2**
Imax: 40kA
Up: 1.3kV
IEC61643-11 **CE**
Red: Replace

PE

Type 2 Surge Arrester

BR-20 4P

Type 2 Surge Arrester

- * Thermal stability 100A without additional protection
- * Patented fast tripping mechanism

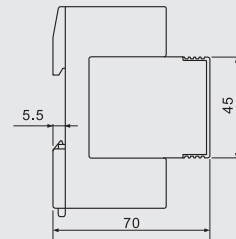
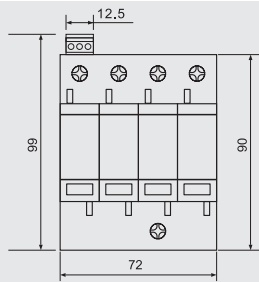
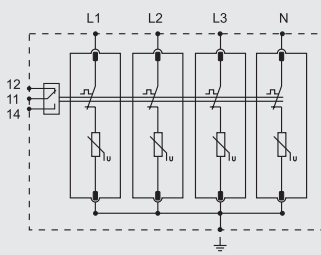

■ BR-20 4 pole surge arrester is suitable for TN-S system.

	BR-20 150 4P	BR-20 275 4P	BR-20 320 4P	BR-20 385 4P	BR-20 440 4P	
SPD classification according to EN61643-11	Type 2	Type 2	Type 2	Type 2	Type 2	
SPD classification according to IEC61643-11	Class II	Class II	Class II	Class II	Class II	
Max. continuous operating a.c. voltage	Uc	150V	275V	320V	385V	440V
Nominal discharge current (8/20µs)	In	10kA	10kA	10kA	10kA	10kA
Max. discharge current (8/20µs)	I _{max}	20kA	20kA	20kA	20kA	20kA
Voltage protection level	Up	≤0.8kV	≤1.3kV	≤1.5kV	≤1.8kV	≤2.0kV
Voltage protection level 5kA	Up	≤0.6kV	≤1kV	≤1.2kV	≤1.4kV	≤1.6kV
Max. backup fuse		63A gG	63A gG	63A gG	63A gG	63A gG
Short-circuit withstand capacity	I _{SCCR}	25kA	25kA	25kA	25kA	25kA
Temporary overvoltage TOV-withstand	U _T	180V/5sec.	335V/5sec.	400V/5sec.	500V/5sec.	580V/5sec.
Temporary overvoltage TOV-safe failure	U _T	230V/120min.	440V/120min.	520V/120min.	650V/120min.	765V/120min.
Response time	t _A	≤25ns	≤25ns	≤25ns	≤25ns	≤25ns
Operating temperature range	T _u	-40°C-80°C	-40°C-80°C	-40°C-80°C	-40°C-80°C	-40°C-80°C
Operating state/fault indication		green/red	green/red	green/red	green/red	green/red
Cross-section area (Min.)		4 mm ²	4 mm ²	4 mm ²	4 mm ²	4 mm ²
Cross-section area (Max.)		35mm ²	35mm ²	35mm ²	35mm ²	35mm ²
For mounting on	35mm Din rail					
Enclosure material	Thermoplastic UL94-V0					
Degree of protection	IP20	IP20	IP20	IP20	IP20	
Order Code	B8701	B8703	B8705	B8707	B8709	
Order Code (With remote signaling)	B8702	B8704	B8706	B8708	B8710	

BR-20 3P

Type 2 Surge Arrester

- * Thermal stability 100A without additional protection
- * Patented fast tripping mechanism

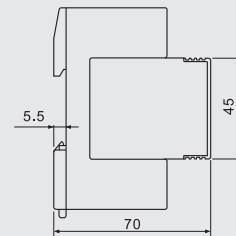
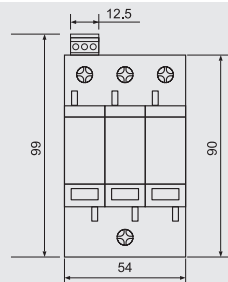
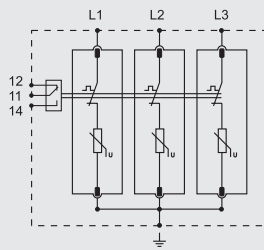
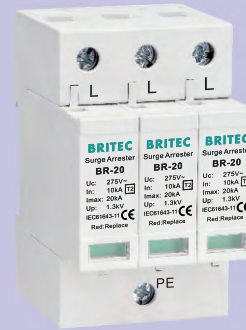

■ BR-20 3 pole surge arrester is suitable for TN-C system.

	BR-20 150 3P	BR-20 275 3P	BR-20 320 3P	BR-20 385 3P	BR-20 440 3P	
SPD classification according to EN61643-11	Type 2	Type 2	Type 2	Type 2	Type 2	
SPD classification according to IEC61643-11	Class II	Class II	Class II	Class II	Class II	
Max. continuous operating a.c. voltage	Uc	150V	275V	320V	440V	
Nominal discharge current (8/20μs)	In	10kA	10kA	10kA	10kA	
Max. discharge current (8/20μs)	I _{max}	20kA	20kA	20kA	20kA	
Voltage protection level	Up	≤0.8kV	≤1.3kV	≤1.5kV	≤1.8kV	≤2.0kV
Voltage protection level 5kA	Up	≤0.6kV	≤1kV	≤1.2kV	≤1.4kV	≤1.6kV
Max. backup fuse		63A gG	63A gG	63A gG	63A gG	63A gG
Short-circuit withstand capacity	I _{SCCR}	25kA	25kA	25kA	25kA	25kA
Temporary overvoltage TOV-withstand	U _T	180V/5sec.	335V/5sec.	400V/5sec.	500V/5sec.	580V/5sec.
Temporary overvoltage TOV-safe failure	U _T	230V/120min.	440V/120min.	520V/120min.	650V/120min.	765V/120min.
Response time	t _A	≤25ns	≤25ns	≤25ns	≤25ns	≤25ns
Operating temperature range	T _u	-40°C-80°C	-40°C-80°C	-40°C-80°C	-40°C-80°C	-40°C-80°C
Operating state/fault indication		green/red	green/red	green/red	green/red	green/red
Cross-section area (Min.)		4 mm ²	4 mm ²	4 mm ²	4 mm ²	4 mm ²
Cross-section area (Max.)		35mm ²	35mm ²	35mm ²	35mm ²	35mm ²
For mounting on	35mm Din rail					
Enclosure material	Thermoplastic UL94-V0					
Degree of protection	IP20	IP20	IP20	IP20	IP20	
Order Code	B8711	B8713	B8715	B8717	B8719	
Order Code (With remote signaling)	B8712	B8714	B8716	B8718	B8720	

BR-20 2P

Type 2 Surge Arrester

- * Thermal stability 100A without additional protection
- * Patented fast tripping mechanism

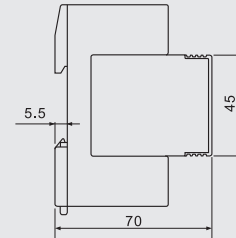
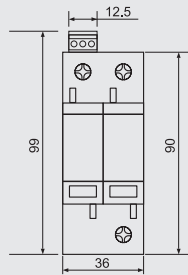
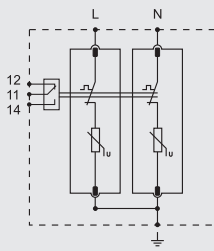

BR-20 2 pole surge arrester is suitable for TN-S system.

	BR-20 150 2P	BR-20 275 2P	BR-20 320 2P	BR-20 385 2P	BR-20 440 2P
SPD classification according to EN61643-11	Type 2	Type 2	Type 2	Type 2	Type 2
SPD classification according to IEC61643-11	Class II	Class II	Class II	Class II	Class II
Max. continuous operating a.c. voltage U_c	150V	275V	320V	385V	440V
Nominal discharge current (8/20 μ s) I_n	10kA	10kA	10kA	10kA	10kA
Max. discharge current (8/20 μ s) I_{max}	20kA	20kA	20kA	20kA	20kA
Voltage protection level U_p	$\leq 0.8kV$	$\leq 1.3kV$	$\leq 1.5kV$	$\leq 1.8kV$	$\leq 2.0kV$
Voltage protection level 5kA U_p	$\leq 0.6kV$	$\leq 1kV$	$\leq 1.2kV$	$\leq 1.4kV$	$\leq 1.6kV$
Max. backup fuse	63A gG	63A gG	63A gG	63A gG	63A gG
Short-circuit withstand capacity I_{SCCR}	25kA	25kA	25kA	25kA	25kA
Temporary overvoltage TOV-withstand U_T	180V/5sec.	335V/5sec.	400V/5sec.	500V/5sec.	580V/5sec.
Temporary overvoltage TOV-safe failure U_T	230V/120min.	440V/120min.	520V/120min.	650V/120min.	765V/120min.
Response time t_A	$\leq 25ns$	$\leq 25ns$	$\leq 25ns$	$\leq 25ns$	$\leq 25ns$
Operating temperature range T_u	-40°C-80°C	-40°C-80°C	-40°C-80°C	-40°C-80°C	-40°C-80°C
Operating state/fault indication	green/red	green/red	green/red	green/red	green/red
Cross-section area (Min.)	4 mm ²	4 mm ²	4 mm ²	4 mm ²	4 mm ²
Cross-section area (Max.)	35mm ²	35mm ²	35mm ²	35mm ²	35mm ²
For mounting on	35mm Din rail				
Enclosure material	Thermoplastic UL94-V0				
Degree of protection	IP20	IP20	IP20	IP20	IP20
Order Code	B8721	B8723	B8725	B8727	B8729
Order Code (With remote signaling)	B8722	B8724	B8726	B8728	B8730

BR-20 1P

Type 2 Surge Arrester

- * Thermal stability 100A without additional protection
- * Patented fast tripping mechanism

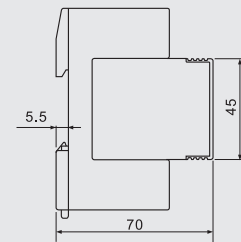
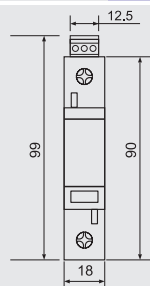
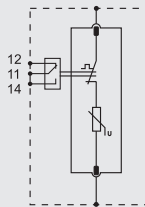

■ BR-20 1P can be used to build 2P, 3P and 4P surge arresters.

	BR-20 150 1P	BR-20 275 1P	BR-20 320 1P	BR-20 385 1P	BR-20 440 1P	
SPD classification according to EN61643-11	Type 2	Type 2	Type 2	Type 2	Type 2	
SPD classification according to IEC61643-11	Class II	Class II	Class II	Class II	Class II	
Max. continuous operating a.c. voltage	U _c	150V	275V	320V	385V	440V
Nominal discharge current (8/20μs)	I _n	10kA	10kA	10kA	10kA	10kA
Max. discharge current (8/20μs)	I _{max}	20kA	20kA	20kA	20kA	20kA
Voltage protection level	U _p	≤0.8kV	≤1.3kV	≤1.5kV	≤1.8kV	≤2.0kV
Voltage protection level 5kA	U _p	≤0.6kV	≤1kV	≤1.2kV	≤1.4kV	≤1.6kV
Max. backup fuse		63A gG	63A gG	63A gG	63A gG	63A gG
Short-circuit withstand capacity	I _{scCR}	25kA	25kA	25kA	25kA	25kA
Temporary overvoltage TOV-withstand	U _T	180V/5sec.	335V/5sec.	400V/5sec.	500V/5sec.	580V/5sec.
Temporary overvoltage TOV-safe failure	U _T	230V/120min.	440V/120min.	520V/120min.	650V/120min.	765V/120min.
Response time	t _A	≤25ns	≤25ns	≤25ns	≤25ns	≤25ns
Operating temperature range	T _u	-40°C-80°C	-40°C-80°C	-40°C-80°C	-40°C-80°C	-40°C-80°C
Operating state/fault indication		green/red	green/red	green/red	green/red	green/red
Cross-section area (Min.)		4 mm ²	4 mm ²	4 mm ²	4 mm ²	4 mm ²
Cross-section area (Max.)		35mm ²	35mm ²	35mm ²	35mm ²	35mm ²
For mounting on	35mm Din rail					
Enclosure material	Thermoplastic UL94-V0					
Degree of protection	IP20	IP20	IP20	IP20	IP20	
Order Code	B8731	B8733	B8735	B8737	B8739	
Order Code (With remote signaling)	B8732	B8734	B8736	B8738	B8740	

BR-20 3+1

Type 2 Surge Arrester

- * Thermal stability 100A without additional protection
- * Patented fast tripping mechanism

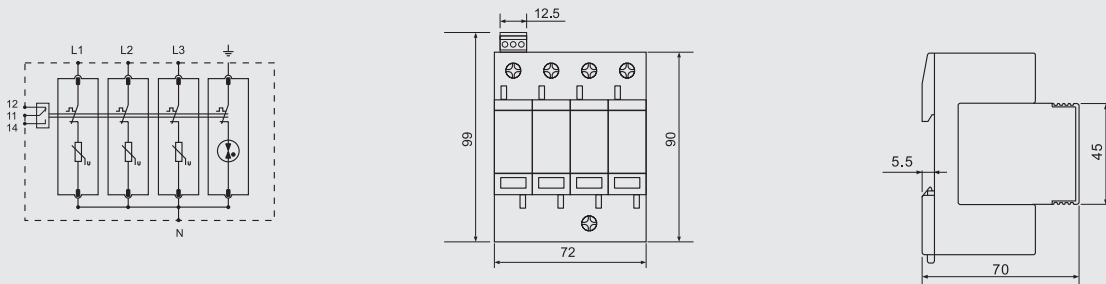

BR-20 3+1 surge arrester is suitable for TT and TN-S system.

	BR-20 150 3+1	BR-20 275 3+1	BR-20 320 3+1	BR-20 385 3+1	BR-20 440 3+1
SPD classification according to EN61643-11	Type 2	Type 2	Type 2	Type 2	Type 2
SPD classification according to IEC61643-11	Class II	Class II	Class II	Class II	Class II
Max. continuous operating a.c. voltage [L-N] U _c	150V	275V	320V	385V	440V
Max. continuous operating a.c. voltage [N-PE] U _c	255V	255V	255V	255V	255V
Nominal discharge current (8/20μs) I _n	10kA	10kA	10kA	10kA	10kA
Max. discharge current (8/20μs) I _{max}	20kA	20kA	20kA	20kA	20kA
Voltage protection level [L-N] U _p	≤0.8kV	≤1.3kV	≤1.5kV	≤1.8kV	≤2.0kV
Voltage protection level 5kA [L-N] U _p	≤0.6kV	≤1kV	≤1.2kV	≤1.4kV	≤1.6kV
Voltage protection level [N-PE] U _p	≤1.5kV	≤1.5kV	≤1.5kV	≤1.5kV	≤1.5kV
Short-circuit withstand capacity I _{SCCR}	25kA	25kA	25kA	25kA	25kA
Temporary overvoltage TOV-withstand [L-N] U _T	180V/5sec.	335V/5sec.	400V/5sec.	500V/5sec.	580V/5sec.
Temporary overvoltage TOV-safe failure [L-N] U _T	230V/120min.	440V/120min.	520V/120min.	650V/120min.	765V/120min.
Temporary overvoltage TOV-withstand [N-PE] U _T	1200V/200ms	1200V/200ms	1200V/200ms	1200V/200ms	1200V/200ms
Follow current extinguishing capability a.c. [N-PE] I _{fi}	100Arms	100Arms	100Arms	100Arms	100Arms
Max. backup fuse	63A gG	63A gG	63A gG	63A gG	63A gG
Response time [L-N] t _A	≤25ns	≤25ns	≤25ns	≤25ns	≤25ns
Response time [N-PE] t _A	≤100ns	≤100ns	≤100ns	≤100ns	≤100ns
Operating temperature range T _u	-40°C-80°C	-40°C-80°C	-40°C-80°C	-40°C-80°C	-40°C-80°C
Operating state/fault indication	green/red	green/red	green/red	green/red	green/red
Cross-section area (Min.)	4 mm ²	4 mm ²	4 mm ²	4 mm ²	4 mm ²
Cross-section area (Max.)	35mm ²	35mm ²	35mm ²	35mm ²	35mm ²
For mounting on	35mm Din rail				
Enclosure material	Thermoplastic UL94-V0				
Degree of protection	IP20	IP20	IP20	IP20	IP20
Order Code	B8741	B8743	B8745	B8747	B8749
Order Code (With remote signaling)	B8742	B8744	B8746	B8748	B8750

BR-20 1+1

Type 2 Surge Arrester

- * Thermal stability 100A without additional protection
- * Patented fast tripping mechanism

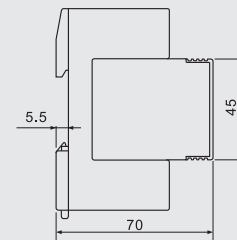
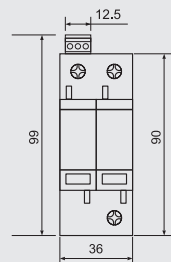
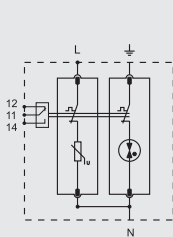

■ BR-20 1+1 surge arrester is suitable for TT and TN-S system.

	BR-20 150 1+1	BR-20 275 1+1	BR-20 320 1+1	BR-20 385 1+1	BR-20 440 1+1
SPD classification according to EN61643-11	Type 2	Type 2	Type 2	Type 2	Type 2
SPD classification according to IEC61643-11	Class II	Class II	Class II	Class II	Class II
Max. continuous operating a.c. voltage [L-N] U _c	150V	275V	320V	385V	440V
Max. continuous operating a.c. voltage [N-PE] U _c	255V	255V	255V	255V	255V
Nominal discharge current (8/20μs) I _n	10kA	10kA	10kA	10kA	10kA
Max. discharge current (8/20μs) I _{max}	20kA	20kA	20kA	20kA	20kA
Voltage protection level [L-N] U _p	≤0.8kV	≤1.3kV	≤1.5kV	≤1.8kV	≤2.0kV
Voltage protection level 5kA [L-N] U _p	≤0.6kV	≤1kV	≤1.2kV	≤1.4kV	≤1.6kV
Voltage protection level [N-PE] U _p	≤1.5kV	≤1.5kV	≤1.5kV	≤1.5kV	≤1.5kV
Short-circuit withstand capacity I _{SCCR}	25kA	25kA	25kA	25kA	25kA
Temporary overvoltage TOV-withstand [L-N] U _T	180V/5sec.	335V/5sec.	400V/5sec.	500V/5sec.	580V/5sec.
Temporary overvoltage TOV-safe failure [L-N] U _T	230V/120min.	440V/120min.	520V/120min.	650V/120min.	765V/120min.
Temporary overvoltage TOV-withstand [N-PE] U _T	1200V/200ms	1200V/200ms	1200V/200ms	1200V/200ms	1200V/200ms
Follow current extinguishing capability a.c. [N-PE]	100Arms	100Arms	100Arms	100Arms	100Arms
Max. backup fuse	63A gG	63A gG	63A gG	63A gG	63A gG
Response time [L-N] t _A	≤25ns	≤25ns	≤25ns	≤25ns	≤25ns
Response time [N-PE] t _A	≤100ns	≤100ns	≤100ns	≤100ns	≤100ns
Operating temperature range T _u	-40°C-80°C	-40°C-80°C	-40°C-80°C	-40°C-80°C	-40°C-80°C
Operating state/fault indication	green/red	green/red	green/red	green/red	green/red
Cross-section area (Min.)	4 mm ²	4 mm ²	4 mm ²	4 mm ²	4 mm ²
Cross-section area (Max.)	35mm ²	35mm ²	35mm ²	35mm ²	35mm ²
For mounting on	35mm Din rail				
Enclosure material	Thermoplastic UL94-V0				
Degree of protection	IP20	IP20	IP20	IP20	IP20
Order Code	B8751	B8753	B8755	B8757	B8759
Order Code (With remote signaling)	B8752	B8754	B8756	B8758	B8760

BR-40 4P

Type 2 Surge Arrester

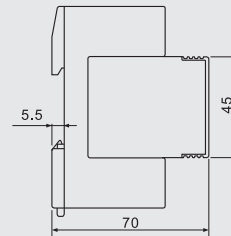
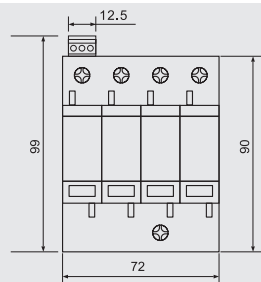
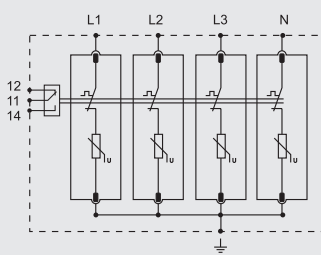
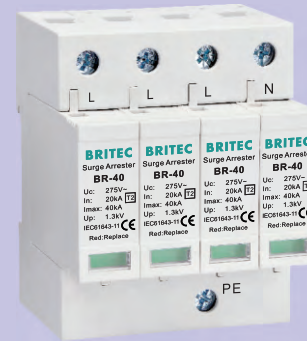

BR-40 4 pole surge arrester is suitable for TN-S system.

	BR-40 150 4P	BR-40 275 4P	BR-40 320 4P	BR-40 385 4P	BR-40 440 4P	
SPD classification according to EN61643-11	Type 2	Type 2	Type 2	Type 2	Type 2	
SPD classification according to IEC61643-11	Class II	Class II	Class II	Class II	Class II	
Max. continuous operating a.c. voltage	Uc	150V	275V	320V	385V	440V
Nominal discharge current (8/20μs)	In	20kA	20kA	20kA	20kA	20kA
Max. discharge current (8/20μs)	Imax	40kA	40kA	40kA	40kA	40kA
Voltage protection level	Up	≤0.8kV	≤1.3kV	≤1.5kV	≤1.8kV	≤2.0kV
Voltage protection level 5kA	Up	≤0.6kV	≤1kV	≤1.2kV	≤1.3kV	≤1.5kV
Max. backup fuse		100A gG	100A gG	100A gG	100A gG	100A gG
Short-circuit withstand capacity	IscCR	25kA	25kA	25kA	25kA	25kA
Temporary overvoltage TOV-withstand	UT	180V/5sec.	335V/5sec.	400V/5sec.	500V/5sec.	580V/5sec.
Temporary overvoltage TOV-safe failure	UT	230V/120min.	440V/120min	520V/120min.	650V/120min.	765V/120min.
Response time	tA	≤25ns	≤25ns	≤25ns	≤25ns	≤25ns
Operating temperature range	Tu	-40°C-80°C	-40°C-80°C	-40°C-80°C	-40°C-80°C	-40°C-80°C
Operating state/fault indication		green/red	green/red	green/red	green/red	green/red
Cross-section area (Min.)		4 mm ²	4 mm ²	4 mm ²	4 mm ²	4 mm ²
Cross-section area (Max.)		35mm ²	35mm ²	35mm ²	35mm ²	35mm ²
For mounting on	35mm Din rail					
Enclosure material	Thermoplastic UL94-V0					
Degree of protection	IP20	IP20	IP20	IP20	IP20	
Order Code	B8401	B8403	B8405	B8407	B8409	
Order Code (With remote signaling)	B8402	B8404	B8406	B8408	B8410	

BR-40 3P

Type 2 Surge Arrester

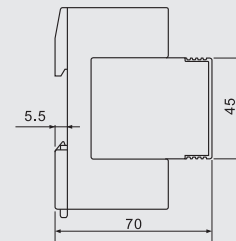
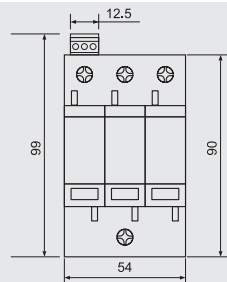
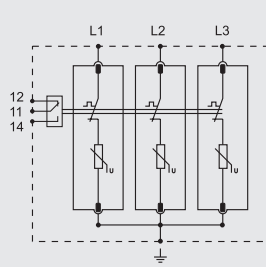
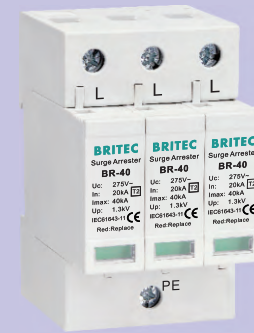

■ BR-40 3 pole surge arrester is suitable for TN-C system.

	BR-40 150 3P	BR-40 275 3P	BR-40 320 3P	BR-40 385 3P	BR-40 440 3P	
SPD classification according to EN61643-11	Type 2	Type 2	Type 2	Type 2	Type 2	
SPD classification according to IEC61643-11	Class II	Class II	Class II	Class II	Class II	
Max. continuous operating a.c. voltage	Uc	150V	275V	320V	385V	440V
Nominal discharge current (8/20μs)	In	20kA	20kA	20kA	20kA	20kA
Max. discharge current (8/20μs)	I _{max}	40kA	40kA	40kA	40kA	40kA
Voltage protection level	Up	≤0.8kV	≤1.3kV	≤1.5kV	≤1.8kV	≤2.0kV
Voltage protection level 5kA	Up	≤0.6kV	≤1kV	≤1.2kV	≤1.3kV	≤1.5kV
Max. backup fuse		100A gG	100A gG	100A gG	100A gG	100A gG
Short-circuit withstand capacity	I _{scCR}	25kA	25kA	25kA	25kA	25kA
Temporary overvoltage TOV-withstand	U _T	180V/5sec.	335V/5sec.	400V/5sec.	500V/5sec.	580V/5sec.
Temporary overvoltage TOV-safe failure	U _T	230V/120min.	440V/120min.	520V/120min.	650V/120min.	765V/120min.
Response time	t _A	≤25ns	≤25ns	≤25ns	≤25ns	≤25ns
Operating temperature range	T _u	-40°C-80°C	-40°C-80°C	-40°C-80°C	-40°C-80°C	-40°C-80°C
Operating state/fault indication		green/red	green/red	green/red	green/red	green/red
Cross-section area (Min.)		4 mm ²	4 mm ²	4 mm ²	4 mm ²	4 mm ²
Cross-section area (Max.)		35mm ²	35mm ²	35mm ²	35mm ²	35mm ²
For mounting on	35mm Din rail					
Enclosure material	Thermoplastic UL94-V0					
Degree of protection	IP20	IP20	IP20	IP20	IP20	
Order Code	B8301	B8303	B8305	B8307	B8309	
Order Code (With remote signaling)	B8302	B8304	B8306	B8308	B8310	

BR-40 2P

Type 2 Surge Arrester

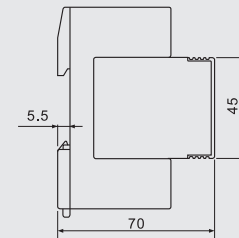
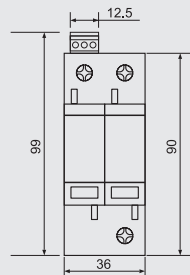
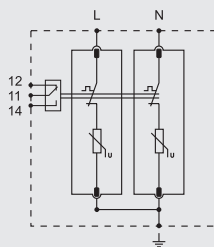
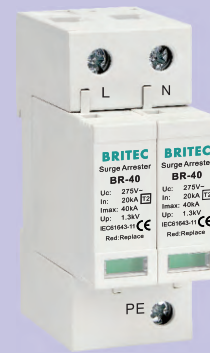

BR-40 2 pole surge arrester is suitable for TN-S system.

	BR-40 150 2P	BR-40 275 2P	BR-40 320 2P	BR-40 385 2P	BR-40 440 2P
SPD classification according to EN61643-11	Type 2	Type 2	Type 2	Type 2	Type 2
SPD classification according to IEC61643-11	Class II	Class II	Class II	Class II	Class II
Max. continuous operating a.c. voltage U_c	150V	275V	320V	385V	440V
Nominal discharge current (8/20 μ s) I_n	20kA	20kA	20kA	20kA	20kA
Max. discharge current (8/20 μ s) I_{max}	40kA	40kA	40kA	40kA	40kA
Voltage protection level U_p	$\leq 0.8kV$	$\leq 1.3kV$	$\leq 1.5kV$	$\leq 1.8kV$	$\leq 2.0kV$
Voltage protection level 5kA U_p	$\leq 0.6kV$	$\leq 1kV$	$\leq 1.2kV$	$\leq 1.3kV$	$\leq 1.5kV$
Max. backup fuse	100A gG	100A gG	100A gG	100A gG	100A gG
Short-circuit withstand capacity I_{SCCR}	25kA	25kA	25kA	25kA	25kA
Temporary overvoltage TOV-withstand U_T	180V/5sec.	335V/5sec.	400V/5sec.	500V/5sec.	580V/5sec.
Temporary overvoltage TOV-safe failure U_T	230V/120min.	440V/120min	520V/120min.	650V/120min.	765V/120min.
Response time t_A	$\leq 25ns$	$\leq 25ns$	$\leq 25ns$	$\leq 25ns$	$\leq 25ns$
Operating temperature range T_u	$-40^{\circ}C-80^{\circ}C$	$-40^{\circ}C-80^{\circ}C$	$-40^{\circ}C-80^{\circ}C$	$-40^{\circ}C-80^{\circ}C$	$-40^{\circ}C-80^{\circ}C$
Operating state/fault indication	green/red	green/red	green/red	green/red	green/red
Cross-section area (Min.)	4 mm ²	4 mm ²	4 mm ²	4 mm ²	4 mm ²
Cross-section area (Max.)	35mm ²	35mm ²	35mm ²	35mm ²	35mm ²
For mounting on	35mm Din rail				
Enclosure material	Thermoplastic UL94-V0				
Degree of protection	IP20	IP20	IP20	IP20	IP20
Order Code	B8201	B8203	B8205	B8207	B8209
Order Code (With remote signaling)	B8202	B8204	B8206	B8208	B8210

BR-40 1P

Type 2 Surge Arrester

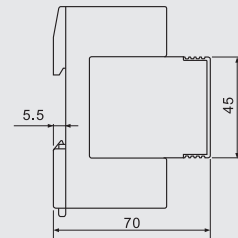
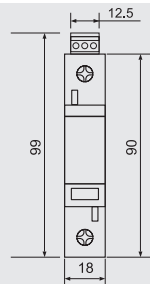
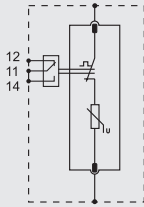

BR-40 1P can be used to build 2P, 3P and 4P surge arresters.

	BR-40 150 1P	BR-40 275 1P	BR-40 320 1P	BR-40 385 1P	BR-40 440 1P	
SPD classification according to EN61643-11	Type 2	Type 2	Type 2	Type 2	Type 2	
SPD classification according to IEC61643-11	Class II	Class II	Class II	Class II	Class II	
Max. continuous operating a.c. voltage	Uc	150V	275V	320V	385V	440V
Nominal discharge current (8/20µs)	In	20kA	20kA	20kA	20kA	20kA
Max. discharge current (8/20µs)	I _{max}	40kA	40kA	40kA	40kA	40kA
Voltage protection level	Up	≤0.8kV	≤1.3kV	≤1.5kV	≤1.8kV	≤2.0kV
Voltage protection level 5kA	Up	≤0.6kV	≤1kV	≤1.2kV	≤1.3kV	≤1.5kV
Max. backup fuse		100A gG	100A gG	100A gG	100A gG	100A gG
Short-circuit withstand capacity	I _{SCCR}	25kA	25kA	25kA	25kA	25kA
Temporary overvoltage TOV-withstand	U _T	180V/5sec.	335V/5sec.	400V/5sec.	500V/5sec.	580V/5sec.
Temporary overvoltage TOV-safe failure	U _T	230V/120min.	440V/120min.	520V/120min.	650V/120min.	765V/120min.
Response time	t _A	≤25ns	≤25ns	≤25ns	≤25ns	≤25ns
Operating temperature range	T _u	-40°C-80°C	-40°C-80°C	-40°C-80°C	-40°C-80°C	-40°C-80°C
Operating state/fault indication		green/red	green/red	green/red	green/red	green/red
Cross-section area (Min.)		4 mm ²	4 mm ²	4 mm ²	4 mm ²	4 mm ²
Cross-section area (Max.)		35mm ²	35mm ²	35mm ²	35mm ²	35mm ²
For mounting on	35mm Din rail					
Enclosure material	Thermoplastic UL94-V0					
Degree of protection	IP20	IP20	IP20	IP20	IP20	
Order Code	B8101	B8103	B8105	B8107	B8109	
Order Code (With remote signaling)	B8102	B8104	B8106	B8108	B8110	

BR-40 3+1

Type 2 Surge Arrester

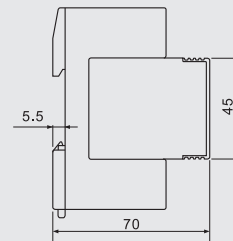
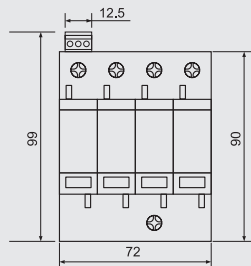
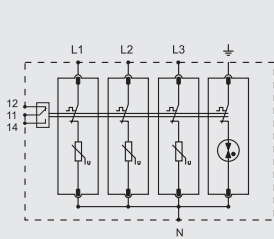
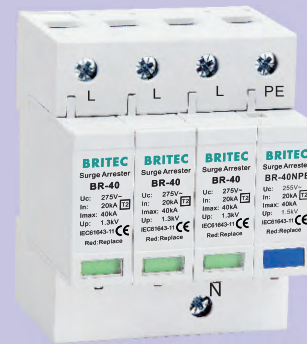

BR-40 3+1 surge arrester is suitable for TT and TN-S system.

	BR-40 150 3+1	BR-40 275 3+1	BR-40 320 3+1	BR-40 385 3+1	BR-40 440 3+1
SPD classification according to EN61643-11	Type 2	Type 2	Type 2	Type 2	Type 2
SPD classification according to IEC61643-11	Class II	Class II	Class II	Class II	Class II
Max. continuous operating a.c. voltage [L-N] U _c	150V	275V	320V	385V	440V
Max. continuous operating a.c. voltage [N-PE] U _c	255V	255V	255V	255V	255V
Nominal discharge current (8/20μs) I _n	20kA	20kA	20kA	20kA	20kA
Max. discharge current (8/20μs) I _{max}	40kA	40kA	40kA	40kA	40kA
Voltage protection level [L-N] U _p	≤0.8kV	≤1.3kV	≤1.5kV	≤1.8kV	≤2.0kV
Voltage protection level 5kA [L-N] U _p	≤0.6kV	≤1kV	≤1.2kV	≤1.3kV	≤1.5kV
Voltage protection level [N-PE] U _p	≤1.5kV	≤1.5kV	≤1.5kV	≤1.5kV	≤1.5kV
Short-circuit withstand capacity I _{SCCR}	25kA	25kA	25kA	25kA	25kA
Temporary overvoltage TOV-withstand [L-N] U _T	180V/5sec.	335V/5sec.	400V/5sec.	500V/5sec.	580V/5sec.
Temporary overvoltage TOV-safe failure [L-N] U _T	230V/120min.	440V/120min	520V/120min.	650V/120min.	765V/120min.
Temporary overvoltage TOV-withstand [N-PE] U _T	1200V/200ms	1200V/200ms	1200V/200ms	1200V/200ms	1200V/200ms
Follow current extinguishing capability a.c. [N-PE] I _{fi}	100Arms	100Arms	100Arms	100Arms	100Arms
Max. backup fuse	100A gG	100A gG	100A gG	100A gG	100A gG
Response time [L-N] t _A	≤25ns	≤25ns	≤25ns	≤25ns	≤25ns
Response time [N-PE] t _A	≤100ns	≤100ns	≤100ns	≤100ns	≤100ns
Operating temperature range T _u	-40°C-80°C	-40°C-80°C	-40°C-80°C	-40°C-80°C	-40°C-80°C
Operating state/fault indication	green/red	green/red	green/red	green/red	green/red
Cross-section area (Min.)	4 mm ²	4 mm ²	4 mm ²	4 mm ²	4 mm ²
Cross-section area (Max.)	35mm ²	35mm ²	35mm ²	35mm ²	35mm ²
For mounting on	35mm Din rail				
Enclosure material	Thermoplastic UL94-V0				
Degree of protection	IP20	IP20	IP20	IP20	IP20
Order Code	B8451	B8453	B8455	B8457	B8249
Order Code (With remote signaling)	B8452	B8454	B8456	B8458	B8250

BR-40 1+1

Type 2 Surge Arrester

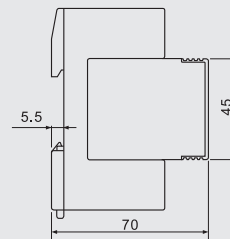
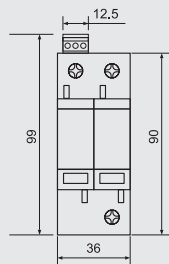
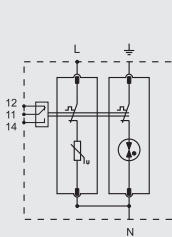

■ BR-40 1+1 surge arrester is suitable for TT and TN-S system.

	BR-40 150 1+1	BR-40 275 1+1	BR-40 320 1+1	BR-40 385 1+1	BR-40 440 1+1
SPD classification according to EN61643-11	Type 2	Type 2	Type 2	Type 2	Type 2
SPD classification according to IEC61643-11	Class II	Class II	Class II	Class II	Class II
Max. continuous operating a.c. voltage [L-N] U _c	150V	275V	320V	385V	440V
Max. continuous operating a.c. voltage [N-PE] U _c	255V	255V	255V	255V	255V
Nominal discharge current (8/20μs) I _n	20kA	20kA	20kA	20kA	20kA
Max. discharge current (8/20μs) I _{max}	40kA	40kA	40kA	40kA	40kA
Voltage protection level [L-N] U _p	≤0.8kV	≤1.3kV	≤1.5kV	≤1.8kV	≤2.0kV
Voltage protection level 5kA [L-N] U _p	≤0.6kV	≤1kV	≤1.2kV	≤1.3kV	≤1.5kV
Voltage protection level [N-PE] U _p	≤1.5kV	≤1.5kV	≤1.5kV	≤1.5kV	≤1.5kV
Short-circuit withstand capacity I _{SCCR}	25kA	25kA	25kA	25kA	25kA
Temporary overvoltage TOV-withstand [L-N] U _T	180V/5sec.	335V/5sec.	400V/5sec.	500V/5sec.	580V/5sec.
Temporary overvoltage TOV-safe failure [L-N] U _T	230V/120min.	440V/120min	520V/120min.	650V/120min.	765V/120min.
Temporary overvoltage TOV-withstand [N-PE] U _T	1200V/200ms	1200V/200ms	1200V/200ms	1200V/200ms	1200V/200ms
Follow current extinguishing capability a.c. [N-PE] I _{fi}	100Arms	100Arms	100Arms	100Arms	100Arms
Max. backup fuse	100A gG	100A gG	100A gG	100A gG	100A gG
Response time [L-N] t _A	≤25ns	≤25ns	≤25ns	≤25ns	≤25ns
Response time [N-PE] t _A	≤100ns	≤100ns	≤100ns	≤100ns	≤100ns
Operating temperature range T _u	-40°C-80°C	-40°C-80°C	-40°C-80°C	-40°C-80°C	-40°C-80°C
Operating state/fault indication	green/red	green/red	green/red	green/red	green/red
Cross-section area (Min.)	4 mm ²	4 mm ²	4 mm ²	4 mm ²	4 mm ²
Cross-section area (Max.)	35mm ²	35mm ²	35mm ²	35mm ²	35mm ²
For mounting on	35mm Din rail				
Enclosure material	Thermoplastic UL94-V0				
Degree of protection	IP20	IP20	IP20	IP20	IP20
Order Code	B8251	B8253	B8255	B8257	B8370
Order Code (With remote signaling)	B8252	B8254	B8256	B8258	B8371

BR-60 4P

Type 2 Surge Arrester

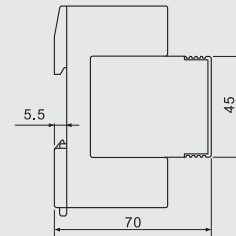
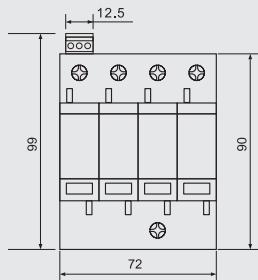
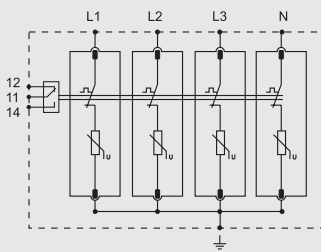
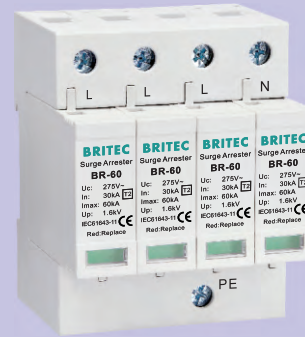

■ BR-60 4 pole surge arrester is suitable for TN-S system.

	BR-60 150 4P	BR-60 275 4P	BR-60 320 4P	BR-60 385 4P
SPD classification according to EN61643-11	Type 2	Type 2	Type 2	Type 2
SPD classification according to IEC61643-11	Class II	Class II	Class II	Class II
Max. continuous operating a.c. voltage	Uc	150V	275V	320V
Nominal discharge current (8/20μs)	In	30kA	30kA	30kA
Max. discharge current (8/20μs)	I _{max}	60kA	60kA	60kA
Voltage protection level	Up	≤1.0kV	≤1.6kV	≤1.8kV
Voltage protection level 5kA	Up	≤0.6kV	≤1kV	≤1.3kV
Max. backup fuse		160A gG	160A gG	160A gG
Short-circuit withstand capacity	I _{SCCR}	25kA	25kA	25kA
Temporary overvoltage TOV-withstand	U _T	180V/5sec.	335V/5sec.	400V/5sec.
Temporary overvoltage TOV-safe failure	U _T	230V/120min.	440V/120min	520V/120min.
Response time	t _A	≤25ns	≤25ns	≤25ns
Operating temperature range	T _u	-40°C-80°C	-40°C-80°C	-40°C-80°C
Operating state/fault indication		green/red	green/red	green/red
Cross-section area (Min.)		4 mm ²	4 mm ²	4 mm ²
Cross-section area (Max.)		35mm ²	35mm ²	35mm ²
For mounting on	35mm Din rail			
Enclosure material	Thermoplastic UL94-V0			
Degree of protection	IP20	IP20	IP20	IP20
Order Code	B8761	B8763	B8765	B8767
Order Code (With remote signaling)	B8762	B8764	B8766	B8768

BR-60 3P

Type 2 Surge Arrester

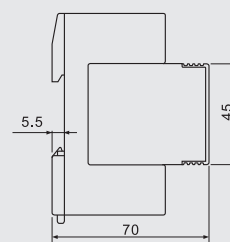
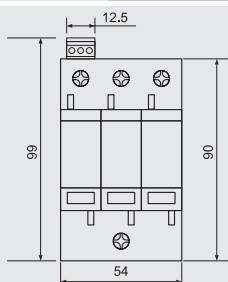
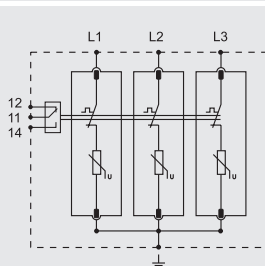
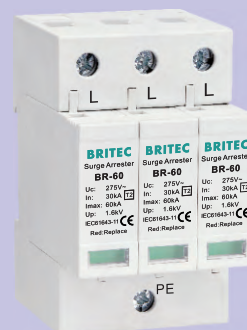

■ BR-60 3 pole surge arrester is suitable for TN-C system.

	BR-60 150 3P	BR-60 275 3P	BR-60 320 3P	BR-60 385 3P
SPD classification according to EN61643-11	Type 2	Type 2	Type 2	Type 2
SPD classification according to IEC61643-11	Class II	Class II	Class II	Class II
Max. continuous operating a.c. voltage	Uc	150V	275V	320V
Nominal discharge current (8/20µs)	In	30kA	30kA	30kA
Max. discharge current (8/20µs)	I _{max}	60kA	60kA	60kA
Voltage protection level	Up	≤ 1.0kV	≤ 1.6kV	≤ 1.8kV
Voltage protection level 5kA	Up	≤ 0.6kV	≤ 1kV	≤ 1.2kV
Max. backup fuse		160A gG	160A gG	160A gG
Short-circuit withstand capacity	I _{SCCR}	25kA	25kA	25kA
Temporary overvoltage TOV-withstand	U _T	180V/5sec.	335V/5sec.	400V/5sec.
Temporary overvoltage TOV-safe failure	U _T	230V/120min.	440V/120min	520V/120min.
Response time	t _A	≤ 25ns	≤ 25ns	≤ 25ns
Operating temperature range	T _u	-40°C-80°C	-40°C-80°C	-40°C-80°C
Operating state/fault indication		green/red	green/red	green/red
Cross-section area (Min.)		4 mm ²	4 mm ²	4 mm ²
Cross-section area (Max.)		35mm ²	35mm ²	35mm ²
For mounting on	35mm Din rail			
Enclosure material	Thermoplastic UL94-V0			
Degree of protection	IP20	IP20	IP20	IP20
Order Code	B8771	B8773	B8775	B8777
Order Code (With remote signaling)	B8772	B8774	B8776	B8778

BR-60 2P

Type 2 Surge Arrester

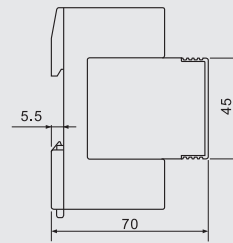
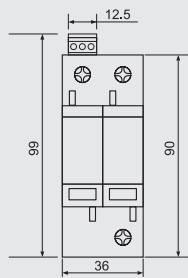
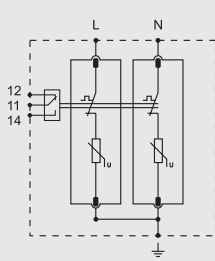

■ BR-60 2 pole surge arrester is suitable for TN-S system.

	BR-60 150 2P	BR-60 275 2P	BR-60 320 2P	BR-60 385 2P
SPD classification according to EN61643-11	Type 2	Type 2	Type 2	Type 2
SPD classification according to IEC61643-11	Class II	Class II	Class II	Class II
Max. continuous operating a.c. voltage	Uc	150V	275V	320V
Nominal discharge current (8/20μs)	In	30kA	30kA	30kA
Max. discharge current (8/20μs)	I _{max}	60kA	60kA	60kA
Voltage protection level	Up	≤1.0kV	≤1.6kV	≤1.8kV
Voltage protection level 5kA	Up	≤0.6kV	≤1kV	≤1.3kV
Max. backup fuse		160A gG	160A gG	160A gG
Short-circuit withstand capacity	I _{SCCR}	25kA	25kA	25kA
Temporary overvoltage TOV-withstand	U _T	180V/5sec.	335V/5sec.	400V/5sec.
Temporary overvoltage TOV-safe failure	U _T	230V/120min.	440V/120min	520V/120min.
Response time	t _A	≤25ns	≤25ns	≤25ns
Operating temperature range	T _u	-40°C-80°C	-40°C-80°C	-40°C-80°C
Operating state/fault indication		green/red	green/red	green/red
Cross-section area (Min.)		4 mm ²	4 mm ²	4 mm ²
Cross-section area (Max.)		35mm ²	35mm ²	35mm ²
For mounting on	35mm Din rail			
Enclosure material	Thermoplastic UL94-V0			
Degree of protection	IP20	IP20	IP20	IP20
Order Code	B8781	B8783	B8785	B8787
Order Code (With remote signaling)	B8782	B8784	B8786	B8788

BR-60 1P

Type 2 Surge Arrester

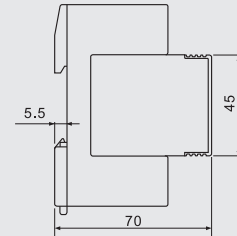
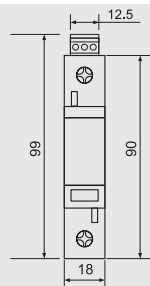
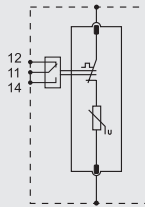

■ BR-60 1P can be used to build 2P, 3P and 4P surge arresters.

	BR-60 150 1P	BR-60 275 1P	BR-60 320 1P	BR-60 385 1P	
SPD classification according to EN61643-11	Type 2	Type 2	Type 2	Type 2	
SPD classification according to IEC61643-11	Class II	Class II	Class II	Class II	
Max. continuous operating a.c. voltage	Uc	150V	275V	320V	385V
Nominal discharge current (8/20μs)	In	30kA	30kA	30kA	30kA
Max. discharge current (8/20μs)	Imax	60kA	60kA	60kA	60kA
Voltage protection level	Up	≤1.0kV	≤1.6kV	≤1.8kV	≤2.2kV
Voltage protection level 5kA	Up	≤0.6kV	≤1kV	≤1.2kV	≤1.3kV
Max. backup fuse		160A gG	160A gG	160A gG	160A gG
Short-circuit withstand capacity	IscCR	25kA	25kA	25kA	25kA
Temporary overvoltage TOV-withstand	UT	180V/5sec.	335V/5sec.	400V/5sec.	500V/5sec.
Temporary overvoltage TOV-safe failure	UT	230V/120min.	440V/120min	520V/120min.	650V/120min.
Response time	tA	≤25ns	≤25ns	≤25ns	≤25ns
Operating temperature range	Tu	-40°C-80°C	-40°C-80°C	-40°C-80°C	-40°C-80°C
Operating state/fault indication		green/red	green/red	green/red	green/red
Cross-section area (Min.)		4 mm ²	4 mm ²	4 mm ²	4 mm ²
Cross-section area (Max.)		35mm ²	35mm ²	35mm ²	35mm ²
For mounting on	35mm Din rail				
Enclosure material	Thermoplastic UL94-V0				
Degree of protection	IP20	IP20	IP20	IP20	
Order Code	B8791	B8793	B8795	B8797	
Order Code (With remote signaling)	B8792	B8794	B8796	B8798	

BR-60 3+1

Type 2 Surge Arrester

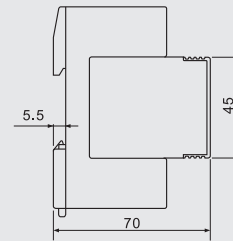
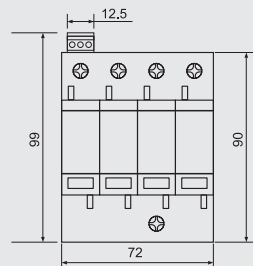
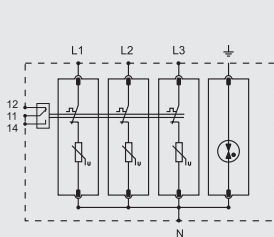

■ BR-60 3+1 surge arrester is suitable for TT and TN-S system.

	BR-60 150 3+1	BR-60 275 3+1	BR-60 320 3+1	BR-60 385 3+1
SPD classification according to EN61643-11	Type 2	Type 2	Type 2	Type 2
SPD classification according to IEC61643-11	Class II	Class II	Class II	Class II
Max. continuous operating a.c. voltage [L-N] Uc	150V	275V	320V	385V
Max. continuous operating a.c. voltage [N-PE] Uc	255V	255V	255V	255V
Nominal discharge current (8/20μs) In	30kA	30kA	30kA	30kA
Max. discharge current (8/20μs) Imax	60kA	60kA	60kA	60kA
Voltage protection level [L-N] Up	≤1.0kV	≤1.6kV	≤1.8kV	≤2.2kV
Voltage protection level 5kA [L-N] Up	≤0.6kV	≤1kV	≤1.2kV	≤1.3kV
Voltage protection level [N-PE] Up	≤1.5kV	≤1.5kV	≤1.5kV	≤1.5kV
Short-circuit withstand capacity IsCCR	25kA	25kA	25kA	25kA
Temporary overvoltage TOV-withstand [L-N] UT	180V/5sec.	335V/5sec.	400V/5sec.	500V/5sec.
Temporary overvoltage TOV-safe failure [L-N] UT	230V/120min.	440V/120min	520V/120min.	650V/120min.
Temporary overvoltage TOV-withstand [N-PE] UT	1200V/200ms	1200V/200ms	1200V/200ms	1200V/200ms
Follow current extinguishing capability a.c. [N-PE] Ifi	100Arms	100Arms	100Arms	100Arms
Max. backup fuse	160A gG	160A gG	160A gG	160A gG
Response time [L-N] tA	≤25ns	≤25ns	≤25ns	≤25ns
Response time [N-PE] tA	≤100ns	≤100ns	≤100ns	≤100ns
Operating temperature range Tu	-40°C-80°C	-40°C-80°C	-40°C-80°C	-40°C-80°C
Operating state/fault indication	green/red	green/red	green/red	green/red
Cross-section area (Min.)	4 mm ²	4 mm ²	4 mm ²	4 mm ²
Cross-section area (Max.)	35mm ²	35mm ²	35mm ²	35mm ²
For mounting on	35mm Din rail			
Enclosure material	Thermoplastic UL94-V0			
Degree of protection	IP20	IP20	IP20	IP20
Order Code	B8801	B8803	B8805	B8807
Order Code (With remote signaling)	B8802	B8804	B8806	B8808

BR-60 1+1

Type 2 Surge Arrester

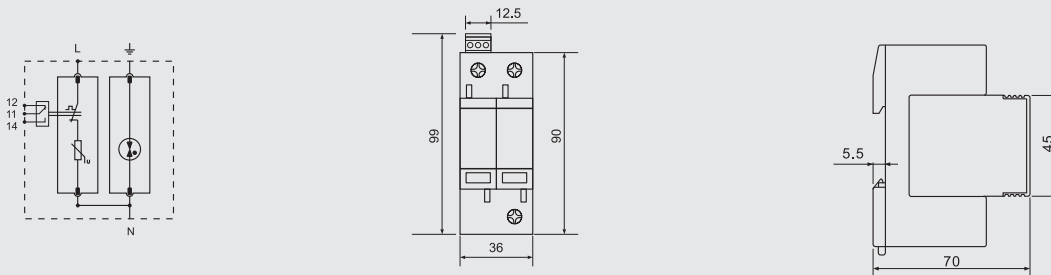

BR-60 1+1 surge arrester is suitable for TT and TN-S system.

	BR-60 150 1+1	BR-60 275 1+1	BR-60 320 1+1	BR-60 385 1+1
SPD classification according to EN61643-11	Type 2	Type 2	Type 2	Type 2
SPD classification according to IEC61643-11	Class II	Class II	Class II	Class II
Max. continuous operating a.c. voltage [L-N] U_c	150V	275V	320V	385V
Max. continuous operating a.c. voltage [N-PE] U_c	255V	255V	255V	255V
Nominal discharge current (8/20 μ s) I_n	30kA	30kA	30kA	30kA
Max. discharge current (8/20 μ s) I_{max}	60kA	60kA	60kA	60kA
Voltage protection level [L-N] U_p	$\leq 1.0kV$	$\leq 1.6kV$	$\leq 1.8kV$	$\leq 2.2kV$
Voltage protection level 5kA [L-N] U_p	$\leq 0.6kV$	$\leq 1kV$	$\leq 1.2kV$	$\leq 1.3kV$
Voltage protection level [N-PE] U_p	$\leq 1.5kV$	$\leq 1.5kV$	$\leq 1.5kV$	$\leq 1.5kV$
Short-circuit withstand capacity I_{SCCR}	25kA	25kA	25kA	25kA
Temporary overvoltage TOV-withstand [L-N] U_T	180V/5sec.	335V/5sec.	400V/5sec.	500V/5sec.
Temporary overvoltage TOV-safe failure [L-N] U_T	230V/120min.	440V/120min	520V/120min.	650V/120min.
Temporary overvoltage TOV-withstand [N-PE] U_T	1200V/200ms	1200V/200ms	1200V/200ms	1200V/200ms
Follow current extinguishing capability a.c. [N-PE] I_{fi}	100Arms	100Arms	100Arms	100Arms
Max. backup fuse	160A gG	160A gG	160A gG	160A gG
Response time [L-N] t_A	$\leq 25ns$	$\leq 25ns$	$\leq 25ns$	$\leq 25ns$
Response time [N-PE] t_A	$\leq 100ns$	$\leq 100ns$	$\leq 100ns$	$\leq 100ns$
Operating temperature range T_u	$-40^{\circ}C - 80^{\circ}C$	$-40^{\circ}C - 80^{\circ}C$	$-40^{\circ}C - 80^{\circ}C$	$-40^{\circ}C - 80^{\circ}C$
Operating state/fault indication	green/red	green/red	green/red	green/red
Cross-section area (Min.)	4 mm ²	4 mm ²	4 mm ²	4 mm ²
Cross-section area (Max.)	35mm ²	35mm ²	35mm ²	35mm ²
For mounting on	35mm Din rail			
Enclosure material	Thermoplastic UL94-V0			
Degree of protection	IP20	IP20	IP20	IP20
Order Code	B8811	B8813	B8815	B8817
Order Code (With remote signaling)	B8812	B8814	B8816	B8818

BR-80 4P

Type 2 Surge Arrester

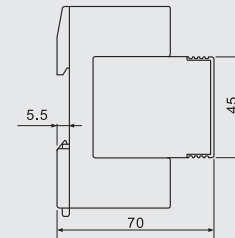
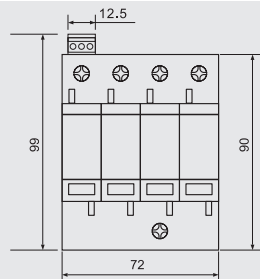
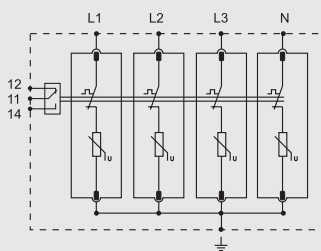
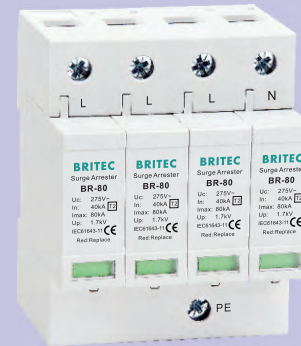

BR-80 4 pole surge arrester is suitable for TN-S system.

	BR-80 150 4P	BR-80 275 4P	BR-80 320 4P	BR-80 385 4P
SPD classification according to EN61643-11	Type 2	Type 2	Type 2	Type 2
SPD classification according to IEC61643-11	Class II	Class II	Class II	Class II
Max. continuous operating a.c. voltage U_c	150V	275V	320V	385V
Nominal discharge current (8/20 μ s) I_n	40kA	40kA	40kA	40kA
Max. discharge current (8/20 μ s) I_{max}	80kA	80kA	80kA	80kA
Voltage protection level U_p	$\leq 1.0kV$	$\leq 1.7kV$	$\leq 2.0kV$	$\leq 2.3kV$
Voltage protection level 5kA U_p	$\leq 0.6kV$	$\leq 1kV$	$\leq 1.1kV$	$\leq 1.2kV$
Max. backup fuse	160A gG	160A gG	160A gG	160A gG
Short-circuit withstand capacity I_{SCCR}	25kA	25kA	25kA	25kA
Temporary overvoltage TOV-withstand U_T	180V/5sec.	335V/5sec.	400V/5sec.	500V/5sec.
Temporary overvoltage TOV-safe failure U_T	230V/120min.	440V/120min	520V/120min.	650V/120min.
Response time t_A	$\leq 25ns$	$\leq 25ns$	$\leq 25ns$	$\leq 25ns$
Operating temperature range T_u	-40°C-80°C	-40°C-80°C	-40°C-80°C	-40°C-80°C
Operating state/fault indication	green/red	green/red	green/red	green/red
Cross-section area (Min.)	4 mm ²	4 mm ²	4 mm ²	4 mm ²
Cross-section area (Max.)	35mm ²	35mm ²	35mm ²	35mm ²
For mounting on	35mm Din rail			
Enclosure material	Thermoplastic UL94-V0			
Degree of protection	IP20	IP20	IP20	IP20
Order Code	B8260	B8262	B8264	B8266
Order Code (With remote signaling)	B8261	B8263	B8265	B8267

BR-80 3P

Type 2 Surge Arrester

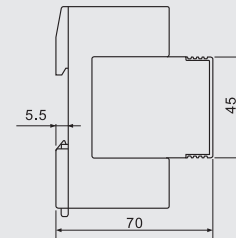
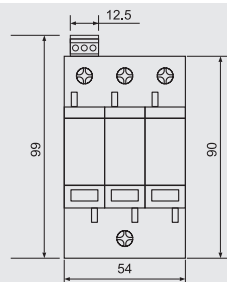
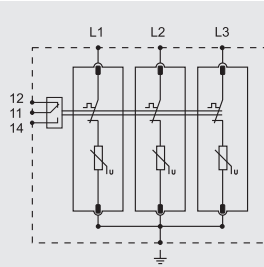

■ BR-80 3 pole surge arrester is suitable for TN-C system.

	BR-80 150 3P	BR-80 275 3P	BR-80 320 3P	BR-80 385 3P
SPD classification according to EN61643-11	Type 2	Type 2	Type 2	Type 2
SPD classification according to IEC61643-11	Class II	Class II	Class II	Class II
Max. continuous operating a.c. voltage	Uc	150V	275V	320V
Nominal discharge current (8/20μs)	In	40kA	40kA	40kA
Max. discharge current (8/20μs)	I _{max}	80kA	80kA	80kA
Voltage protection level	Up	≤1.0kV	≤1.7kV	≤2.0kV
Voltage protection level 5kA	Up	≤0.6kV	≤1kV	≤1.1kV
Max. backup fuse		160A gG	160A gG	160A gG
Short-circuit withstand capacity	I _{SCCR}	25kA	25kA	25kA
Temporary overvoltage TOV-withstand	U _T	180V/5sec.	335V/5sec.	400V/5sec.
Temporary overvoltage TOV-safe failure	U _T	230V/120min.	440V/120min	520V/120min.
Response time	t _A	≤25ns	≤25ns	≤25ns
Operating temperature range	T _u	-40°C-80°C	-40°C-80°C	-40°C-80°C
Operating state/fault indication		green/red	green/red	green/red
Cross-section area (Min.)		4 mm ²	4 mm ²	4 mm ²
Cross-section area (Max.)		35mm ²	35mm ²	35mm ²
For mounting on	35mm Din rail			
Enclosure material	Thermoplastic UL94-V0			
Degree of protection	IP20	IP20	IP20	IP20
Order Code	B8268	B8270	B8272	B8274
Order Code (With remote signaling)	B8269	B8271	B8273	B8275

BR-80 2P

Type 2 Surge Arrester

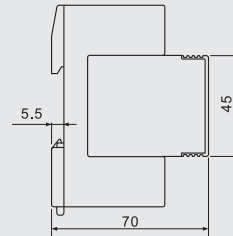
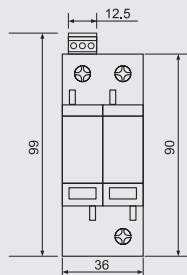
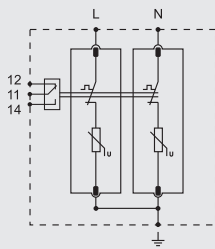

■ BR-80 2 pole surge arrester is suitable for TN-S system.

	BR-80 150 2P	BR-80 275 2P	BR-80 320 2P	BR-80 385 2P
SPD classification according to EN61643-11	Type 2	Type 2	Type 2	Type 2
SPD classification according to IEC61643-11	Class II	Class II	Class II	Class II
Max. continuous operating a.c. voltage	Uc	150V	275V	320V
Nominal discharge current (8/20μs)	In	40kA	40kA	40kA
Max. discharge current (8/20μs)	Imax	80kA	80kA	80kA
Voltage protection level	Up	≤1.0kV	≤1.7kV	≤2.0kV
Voltage protection level 5kA	Up	≤0.6kV	≤1kV	≤1.1kV
Max. backup fuse		160A gG	160A gG	160A gG
Short-circuit withstand capacity	ISCCR	25kA	25kA	25kA
Temporary overvoltage TOV-withstand	UT	180V/5sec.	335V/5sec.	400V/5sec.
Temporary overvoltage TOV-safe failure	UT	230V/120min.	440V/120min	520V/120min.
Response time	tA	≤25ns	≤25ns	≤25ns
Operating temperature range	Tu	-40°C-80°C	-40°C-80°C	-40°C-80°C
Operating state/fault indication		green/red	green/red	green/red
Cross-section area (Min.)		4 mm ²	4 mm ²	4 mm ²
Cross-section area (Max.)		35mm ²	35mm ²	35mm ²
For mounting on	35mm Din rail			
Enclosure material	Thermoplastic UL94-V0			
Degree of protection	IP20	IP20	IP20	IP20
Order Code	B8276	B8278	B8280	B8282
Order Code (With remote signaling)	B8277	B8279	B8281	B8283

BR-80 1P

Type 2 Surge Arrester

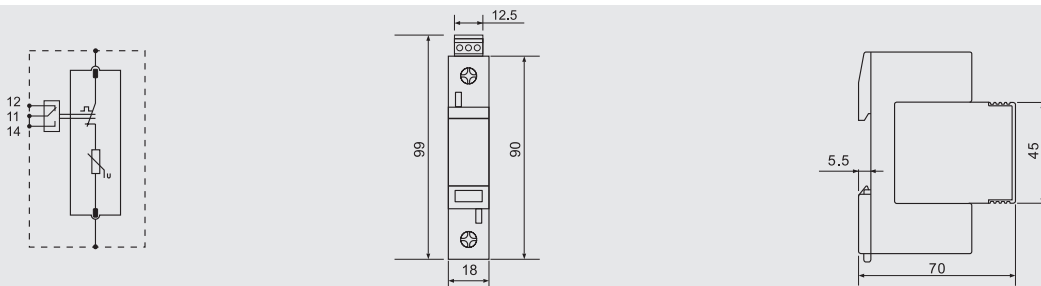

■ BR-80 1P can be used to build 2P, 3P and 4P surge arresters.

		BR-80 150 1P	BR-80 275 1P	BR-80 320 1P	BR-80 385 1P
SPD classification according to EN61643-11		Type 2	Type 2	Type 2	Type 2
SPD classification according to IEC61643-11		Class II	Class II	Class II	Class II
Max. continuous operating a.c. voltage	Uc	150V	275V	320V	385V
Nominal discharge current (8/20µs)	In	40kA	40kA	40kA	40kA
Max. discharge current (8/20µs)	I _{max}	80kA	80kA	80kA	80kA
Voltage protection level	Up	≤1.0kV	≤1.7kV	≤2.0kV	≤2.3kV
Voltage protection level 5kA	Up	≤0.6kV	≤1kV	≤1.1kV	≤1.2kV
Max. backup fuse		160A gG	160A gG	160A gG	160A gG
Short-circuit withstand capacity	I _{SCCR}	25kA	25kA	25kA	25kA
Temporary overvoltage TOV-withstand	U _T	180V/5sec.	335V/5sec.	400V/5sec.	500V/5sec.
Temporary overvoltage TOV-safe failure	U _T	230V/120min.	440V/120min	520V/120min.	650V/120min.
Response time	t _A	≤25ns	≤25ns	≤25ns	≤25ns
Operating temperature range	T _u	-40°C-80°C	-40°C-80°C	-40°C-80°C	-40°C-80°C
Operating state/fault indication		green/red	green/red	green/red	green/red
Cross-section area (Min.)		4 mm ²	4 mm ²	4 mm ²	4 mm ²
Cross-section area (Max.)		35mm ²	35mm ²	35mm ²	35mm ²
For mounting on		35mm Din rail			
Enclosure material		Thermoplastic UL94-V0			
Degree of protection		IP20	IP20	IP20	IP20
Order Code		B8284	B8286	B8288	B8290
Order Code (With remote signaling)		B8285	B8287	B8289	B8291

BR-80 3+1

Type 2 Surge Arrester

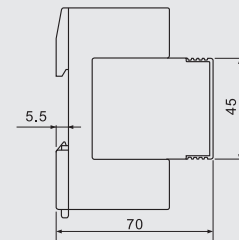
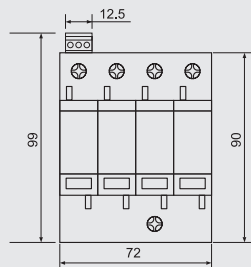
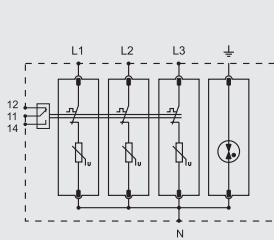

BR-80 3+1 surge arrester is suitable for TT and TN-S system.

	BR-80 150 3+1	BR-80 275 3+1	BR-80 320 3+1	BR-80 385 3+1
SPD classification according to EN61643-11	Type 2	Type 2	Type 2	Type 2
SPD classification according to IEC61643-11	Class II	Class II	Class II	Class II
Max. continuous operating a.c. voltage [L-N] Uc	150V	275V	320V	385V
Max. continuous operating a.c. voltage [N-PE] Uc	255V	255V	255V	255V
Nominal discharge current (8/20μs) In	40kA	40kA	40kA	40kA
Max. discharge current (8/20μs) Imax	80kA	80kA	80kA	80kA
Voltage protection level [L-N] Up	≤1.0kV	≤1.7kV	≤2.0kV	≤2.3kV
Voltage protection level 5kA [L-N] Up	≤0.6kV	≤1kV	≤1.1kV	≤1.2kV
Voltage protection level [N-PE] Up	≤1.5kV	≤1.5kV	≤1.5kV	≤1.5kV
Short-circuit withstand capacity IsCCR	25kA	25kA	25kA	25kA
Temporary overvoltage TOV-withstand [L-N] UT	180V/5sec.	335V/5sec.	400V/5sec.	500V/5sec.
Temporary overvoltage TOV-safe failure [L-N] UT	230V/120min.	440V/120min	520V/120min.	650V/120min.
Temporary overvoltage TOV-withstand [N-PE] UT	1200V/200ms	1200V/200ms	1200V/200ms	1200V/200ms
Follow current extinguishing capability a.c. [N-PE] Ifi	100Arms	100Arms	100Arms	100Arms
Max. backup fuse	160A gG	160A gG	160A gG	160A gG
Response time [L-N] tA	≤25ns	≤25ns	≤25ns	≤25ns
Response time [N-PE] tA	≤100ns	≤100ns	≤100ns	≤100ns
Operating temperature range Tu	-40°C-80°C	-40°C-80°C	-40°C-80°C	-40°C-80°C
Operating state/fault indication	green/red	green/red	green/red	green/red
Cross-section area (Min.)	4 mm ²	4 mm ²	4 mm ²	4 mm ²
Cross-section area (Max.)	35mm ²	35mm ²	35mm ²	35mm ²
For mounting on	35mm Din rail			
Enclosure material	Thermoplastic UL94-V0			
Degree of protection	IP20	IP20	IP20	IP20
Order Code	B8292	B8294	B8296	B8298
Order Code (With remote signaling)	B8293	B8295	B8297	B8888

BR-80 1+1

Type 2 Surge Arrester

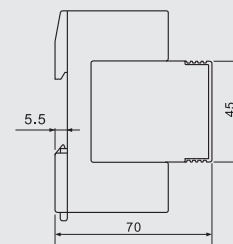
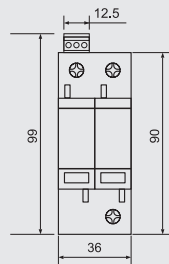
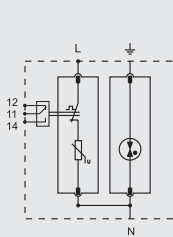

■ BR-80 1+1 surge arrester is suitable for TT and TN-S system.

	BR-80 150 1+1	BR-80 275 1+1	BR-80 320 1+1	BR-80 385 1+1
SPD classification according to EN61643-11	Type 2	Type 2	Type 2	Type 2
SPD classification according to IEC61643-11	Class II	Class II	Class II	Class II
Max. continuous operating a.c. voltage [L-N] U _c	150V	275V	320V	385V
Max. continuous operating a.c. voltage [N-PE] U _c	255V	255V	255V	255V
Nominal discharge current (8/20μs) I _n	40kA	40kA	40kA	40kA
Max. discharge current (8/20μs) I _{max}	80kA	80kA	80kA	80kA
Voltage protection level [L-N] U _p	≤1.0kV	≤1.7kV	≤2.0kV	≤2.3kV
Voltage protection level 5kA [L-N] U _p	≤0.6kV	≤1kV	≤1.1kV	≤1.2kV
Voltage protection level [N-PE] U _p	≤1.5kV	≤1.5kV	≤1.5kV	≤1.5kV
Short-circuit withstand capacity I _{SCCR}	25kA	25kA	25kA	25kA
Temporary overvoltage TOV-withstand [L-N] U _T	180V/5sec.	335V/5sec.	400V/5sec.	500V/5sec.
Temporary overvoltage TOV-safe failure [L-N] U _T	230V/120min.	440V/120min	520V/120min.	650V/120min.
Temporary overvoltage TOV-withstand [N-PE] U _T	1200V/200ms	1200V/200ms	1200V/200ms	1200V/200ms
Follow current extinguishing capability a.c. [N-PE] I _{fi}	100Arms	100Arms	100Arms	100Arms
Max. backup fuse	160A gG	160A gG	160A gG	160A gG
Response time [L-N] t _A	≤25ns	≤25ns	≤25ns	≤25ns
Response time [N-PE] t _A	≤100ns	≤100ns	≤100ns	≤100ns
Operating temperature range T _u	-40°C-80°C	-40°C-80°C	-40°C-80°C	-40°C-80°C
Operating state/fault indication	green/red	green/red	green/red	green/red
Cross-section area (Min.)	4 mm ²	4 mm ²	4 mm ²	4 mm ²
Cross-section area (Max.)	35mm ²	35mm ²	35mm ²	35mm ²
For mounting on	35mm Din rail			
Enclosure material	Thermoplastic UL94-V0			
Degree of protection	IP20	IP20	IP20	IP20
Order Code	B8360	B8362	B8364	B8366
Order Code (With remote signaling)	B8361	B8363	B8365	B8367

BR-100 4P

Type 2 Surge Arrester

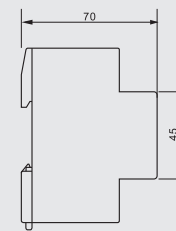
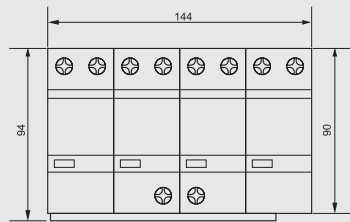
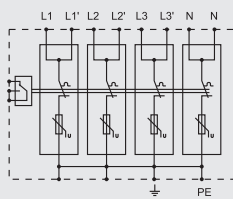

■ BR-100 4pole surge arrester is suitable for TN-S system.

	BR-100 275 4P	BR-100 320 4P	BR-100 385 4P
SPD classification according to EN61643-11	Type 2	Type 2	Type 2
SPD classification according to IEC61643-11	Class II	Class II	Class II
Max. continuous operating a.c. voltage	Uc	275V	320V
Nominal discharge current (8/20μs)	In	50kA	50kA
Max. discharge current (8/20μs)	I _{max}	100kA	100kA
Voltage protection level	Up	≤1.8kV	≤2.0kV
Voltage protection level 5kA	Up	≤1kV	≤1.2kV
Max. backup fuse		160A gG	160A gG
Short-circuit withstand capacity	I _{SCCR}	25kA	25kA
Temporary overvoltage TOV-withstand	U _T	335V/5sec.	400V/5sec.
Temporary overvoltage TOV-safe failure	U _T	440V/120min.	520V/120min.
Response time	t _A	≤25ns	≤25ns
Operating temperature range	T _u	-40°C-80°C	-40°C-80°C
Operating state/fault indication		green/red	green/red
Cross-section area (Min.)		4 mm ²	4 mm ²
Cross-section area (Max.)		35mm ²	35mm ²
For mounting on		35mm Din rail	
Enclosure material		Thermoplastic UL94-V0	
Degree of protection		IP20	IP20
Order Code		B8823	B8825
Order Code (With remote signaling)		B8824	B8826

BR-100 3P

Type 2 Surge Arrester

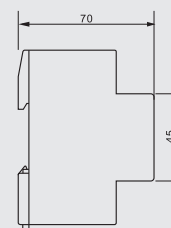
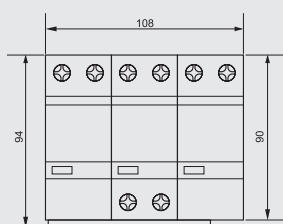
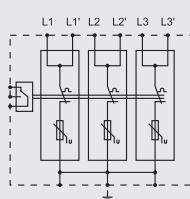

■ BR-100 3pole surge arrester is suitable for TN-C system.

		BR-100 275 3P	BR-100 320 3P	BR-100 385 3P
SPD classification according to EN61643-11		Type 2	Type 2	Type 2
SPD classification according to IEC61643-11		Class II	Class II	Class II
Max. continuous operating a.c. voltage	Uc	275V	320V	385V
Nominal discharge current (8/20μs)	In	50kA	50kA	50kA
Max. discharge current (8/20μs)	I _{max}	100kA	100kA	100kA
Voltage protection level	Up	≤1.8kV	≤2.0kV	≤2.5kV
Voltage protection level 5kA	Up	≤1kV	≤1.1kV	≤1.2kV
Max. backup fuse		160A gG	160A gG	160A gG
Short-circuit withstand capacity	I _{SCCR}	25kA	25kA	25kA
Temporary overvoltage TOV-withstand	U _T	335V/5sec.	400V/5sec.	500V/5sec.
Temporary overvoltage TOV-safe failure	U _T	440V/120min.	520V/120min.	650V/120min.
Response time	t _A	≤25ns	≤25ns	≤25ns
Operating temperature range	T _u	-40°C-80°C	-40°C-80°C	-40°C-80°C
Operating state/fault indication		green/red	green/red	green/red
Cross-section area (Min.)		4 mm ²	4 mm ²	4 mm ²
Cross-section area (Max.)		35mm ²	35mm ²	35mm ²
For mounting on		35mm Din rail		
Enclosure material		Thermoplastic UL94-V0		
Degree of protection		IP20	IP20	IP20
Order Code		B8833	B8835	B8837
Order Code (With remote signaling)		B8834	B8836	B8838

BR-100 2P

Type 2 Surge Arrester

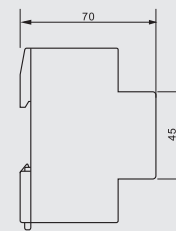
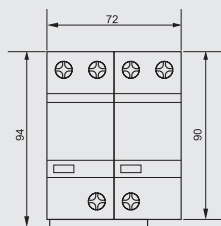
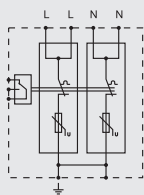

■ BR-100 2pole surge arrester is suitable for TN-S system.

		BR-100 275 2P	BR-100 320 2P	BR-100 385 2P
SPD classification according to EN61643-11		Type 2	Type 2	Type 2
SPD classification according to IEC61643-11		Class II	Class II	Class II
Max. continuous operating a.c. voltage	Uc	275V	320V	385V
Nominal discharge current (8/20μs)	In	50kA	50kA	50kA
Max. discharge current (8/20μs)	I _{max}	100kA	100kA	100kA
Voltage protection level	Up	≤1.8kV	≤2.0kV	≤2.5kV
Voltage protection level 5kA	Up	≤1kV	≤1.1kV	≤1.2kV
Max. backup fuse		160A gG	160A gG	160A gG
Short-circuit withstand capacity	I _{SCCR}	25kA	25kA	25kA
Temporary overvoltage TOV-withstand	U _T	335V/5sec.	400V/5sec.	500V/5sec.
Temporary overvoltage TOV-safe failure	U _T	440V/120min.	520V/120min.	650V/120min.
Response time	t _A	≤25ns	≤25ns	≤25ns
Operating temperature range	T _u	-40°C-80°C	-40°C-80°C	-40°C-80°C
Operating state/fault indication		green/red	green/red	green/red
Cross-section area (Min.)		4 mm ²	4 mm ²	4 mm ²
Cross-section area (Max.)		35mm ²	35mm ²	35mm ²
For mounting on		35mm Din rail		
Enclosure material		Thermoplastic UL94-V0		
Degree of protection		IP20	IP20	IP20
Order Code		B8843	B8845	B8847
Order Code (With remote signaling)		B8844	B8846	B8848

BR-100 1P

Type 2 Surge Arrester

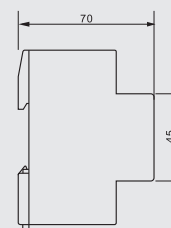
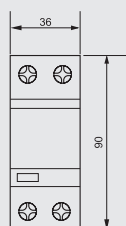
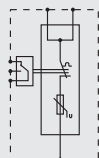

■ BR-100 1pole can form 1-4 poles.

		BR-100 275 1P	BR-100 320 1P	BR-100 385 1P
SPD classification according to EN61643-11		Type 2	Type 2	Type 2
SPD classification according to IEC61643-11		Class II	Class II	Class II
Max. continuous operating a.c. voltage	Uc	275V	320V	385V
Nominal discharge current (8/20μs)	In	50kA	50kA	50kA
Max. discharge current (8/20μs)	Imax	100kA	100kA	100kA
Voltage protection level	Up	≤1.8kV	≤2.0kV	≤2.5kV
Voltage protection level 5kA	Up	≤1kV	≤1.1kV	≤1.2kV
Max. backup fuse		160A gG	160A gG	160A gG
Short-circuit withstand capacity	IscCR	25kA	25kA	25kA
Temporary overvoltage TOV-withstand	UT	335V/5sec.	400V/5sec.	500V/5sec.
Temporary overvoltage TOV-safe failure	UT	440V/120min.	520V/120min.	650V/120min.
Response time	tA	≤25ns	≤25ns	≤25ns
Operating temperature range	Tu	-40°C-80°C	-40°C-80°C	-40°C-80°C
Operating state/fault indication		green/red	green/red	green/red
Cross-section area (Min.)		4 mm ²	4 mm ²	4 mm ²
Cross-section area (Max.)		35mm ²	35mm ²	35mm ²
For mounting on		35mm Din rail		
Enclosure material		Thermoplastic UL94-V0		
Degree of protection		IP20	IP20	IP20
Order Code		B8853	B8855	B8857
Order Code (With remote signaling)		B8854	B8856	B8858

BR-100 3+1

Type 2 Surge Arrester

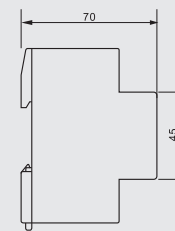
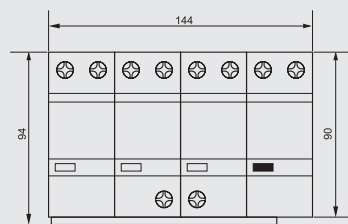
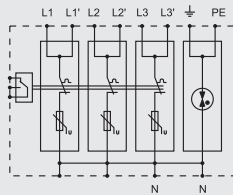

BR-100 3+1 surge arrester is suitable for TT and TN-S system.

	BR-100 275 3+1	BR-100 320 3+1	BR-100 385 3+1
SPD classification according to EN61643-11	Type 2	Type 2	Type 2
SPD classification according to IEC61643-11	Class II	Class II	Class II
Max. continuous operating a.c. voltage [L-N] U _c	275V	320V	385V
Max. continuous operating a.c. voltage [N-PE] U _c	255V	255V	255V
Nominal discharge current (8/20μs) [L-N/N-PE] I _n	50kA/100kA	50kA/100kA	50kA/100kA
Max. discharge current (8/20μs) [L-N/N-N-PE] I _{max}	100kA/160kA	100kA/160kA	100kA/160kA
Voltage protection level [L-N] U _p	≤1.8kV	≤2.0kV	≤2.5kV
Voltage protection level 5kA [L-N] U _p	≤1kV	≤1.1kV	≤1.2kV
Voltage protection level [N-PE] U _p	≤1.5kV	≤1.5kV	≤1.5kV
Short-circuit withstand capacity I _{SCCR}	25kA	25kA	25kA
Temporary overvoltage TOV-withstand [L-N] U _T	335V/5sec.	400V/5sec.	500V/5sec.
Temporary overvoltage TOV-safe failure [L-N] U _T	440V/120min.	520V/120min.	650V/120min.
Temporary overvoltage TOV-withstand [N-PE] U _T	1200V/200ms	1200V/200ms	1200V/200ms
Follow current extinguishing capability a.c. [N-PE] I _{fi}	100Arms	100Arms	100Arms
Max. backup fuse	160A gG	160A gG	160A gG
Response time [L-N] t _A	≤25ns	≤25ns	≤25ns
Response time [N-PE] t _A	≤100ns	≤100ns	≤100ns
Operating temperature range T _u	-40°C-80°C	-40°C-80°C	-40°C-80°C
Operating state/fault indication	green/red	green/red	green/red
Cross-section area (Min.)	4 mm ²	4 mm ²	4 mm ²
Cross-section area (Max.)	35mm ²	35mm ²	35mm ²
For mounting on	35mm Din rail		
Enclosure material	Thermoplastic UL94-V0		
Degree of protection	IP20	IP20	IP20
Order Code	B8863	B8865	B8867
Order Code (With remote signaling)	B8864	B8866	B8868

BR-100 1+1

Type 2 Surge Arrester

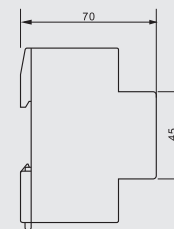
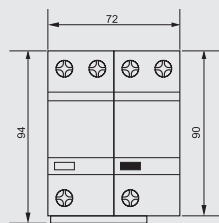
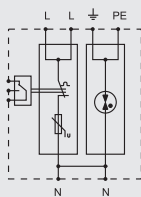

■ BR-100 1+1 surge arrester is suitable for TT and TN-S system.

	BR-100 275 1+1	BR-100 320 1+1	BR-100 385 1+1
SPD classification according to EN61643-11	Type 2	Type 2	Type 2
SPD classification according to IEC61643-11	Class II	Class II	Class II
Max. continuous operating a.c. voltage [L-N] Uc	275V	320V	385V
Max. continuous operating a.c. voltage [N-PE] Uc	255V	255V	255V
Nominal discharge current (8/20 μ s) [L-N/N-PE] In	50kA/100kA	50kA/100kA	50kA/100kA
Max. discharge current (8/20 μ s) [L-N/N-N-PE] Imax	100kA/160kA	100kA/160kA	100kA/160kA
Voltage protection level [L-N] Up	≤ 1.8 kV	≤ 2.0 kV	≤ 2.5 kV
Voltage protection level 5kA [L-N] Up	≤ 1 kV	≤ 1.1 kV	≤ 1.2 kV
Voltage protection level [N-PE] Up	≤ 1.5 kV	≤ 1.5 kV	≤ 1.5 kV
Short-circuit withstand capacity IsCCR	25kA	25kA	25kA
Temporary overvoltage TOV-withstand [L-N] UT	335V/5sec.	400V/5sec.	500V/5sec.
Temporary overvoltage TOV-safe failure [L-N] UT	440V/120min.	520V/120min.	650V/120min.
Temporary overvoltage TOV-withstand [N-PE] UT	1200V/200ms	1200V/200ms	1200V/200ms
Follow current extinguishing capability a.c. [N-PE] Ifi	100Arms	100Arms	100Arms
Max. backup fuse	160A gG	160A gG	160A gG
Response time [L-N] tA	≤ 25 ns	≤ 25 ns	≤ 25 ns
Response time [N-PE] tA	≤ 100 ns	≤ 100 ns	≤ 100 ns
Operating temperature range Tu	-40 $^{\circ}$ C-80 $^{\circ}$ C	-40 $^{\circ}$ C-80 $^{\circ}$ C	-40 $^{\circ}$ C-80 $^{\circ}$ C
Operating state/fault indication	green/red	green/red	green/red
Cross-section area (Min.)	4 mm ²	4 mm ²	4 mm ²
Cross-section area (Max.)	35mm ²	35mm ²	35mm ²
For mounting on	35mm Din rail		
Enclosure material	Thermoplastic UL94-V0		
Degree of protection	IP20	IP20	IP20
Order Code	B8873	B8875	B8877
Order Code (With remote signaling)	B8874	B8876	B8878

BR-200 4P

Type 2 Surge Arrester

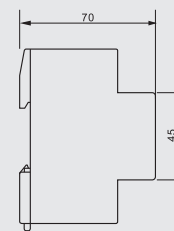
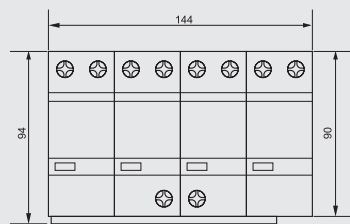
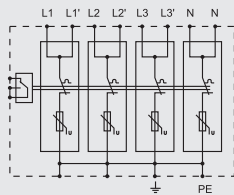

■ BR-200 4pole surge arrester is suitable for TN-S system.

	BR-200 275 4P	BR-200 320 4P	BR-200 385 4P
SPD classification according to EN61643-11	Type 2	Type 2	Type 2
SPD classification according to IEC61643-11	Class II	Class II	Class II
Max. continuous operating a.c. voltage	Uc	275V	320V
Nominal discharge current (8/20μs)	In	100kA	100kA
Max. discharge current (8/20μs)	I _{max}	200kA	200kA
Voltage protection level	Up	≤1.9kV	≤2.1kV
Voltage protection level 5kA	Up	≤0.6kV	≤1kV
Max. backup fuse		350A gG	350A gG
Short-circuit withstand capacity	I _{SCCR}	25kA	25kA
Temporary overvoltage TOV-withstand	U _T	335V/5sec.	400V/5sec.
Temporary overvoltage TOV-safe failure	U _T	440V/120min.	520V/120min.
Response time	t _A	≤25ns	≤25ns
Operating temperature range	T _u	-40°C-80°C	-40°C-80°C
Operating state/fault indication		green/red	green/red
Cross-section area (Min.)		4 mm ²	4 mm ²
Cross-section area (Max.)		35mm ²	35mm ²
For mounting on	35mm Din rail		
Enclosure material	Thermoplastic UL94-V0		
Degree of protection	IP20	IP20	IP20
Order Code	B7402	B7404	B7406
Order Code (With remote signaling)	B7403	B7405	B7407

BR-200 3P

Type 2 Surge Arrester

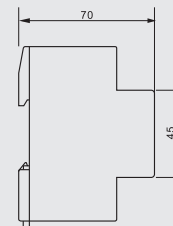
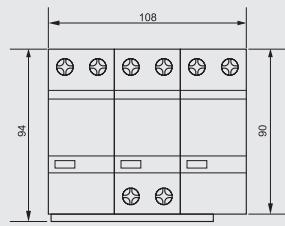
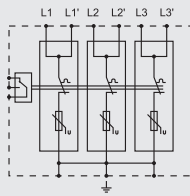

■ BR-200 3pole surge arrester is suitable for TN-C system.

	BR-200 275 3P	BR-200 320 3P	BR-200 385 3P
SPD classification according to EN61643-11	Type 2	Type 2	Type 2
SPD classification according to IEC61643-11	Class II	Class II	Class II
Max. continuous operating a.c. voltage	Uc	275V	320V
Nominal discharge current (8/20μs)	In	100kA	100kA
Max. discharge current (8/20μs)	Imax	200kA	200kA
Voltage protection level	Up	≤1.9kV	≤2.1kV
Voltage protection level 5kA	Up	≤0.6kV	≤1kV
Max. backup fuse		350A gG	350A gG
Short-circuit withstand capacity	IscCR	25kA	25kA
Temporary overvoltage TOV-withstand	UT	335V/5sec.	400V/5sec.
Temporary overvoltage TOV-safe failure	UT	440V/120min.	520V/120min.
Response time	tA	≤25ns	≤25ns
Operating temperature range	Tu	-40°C-80°C	-40°C-80°C
Operating state/fault indication		green/red	green/red
Cross-section area (Min.)		4 mm ²	4 mm ²
Cross-section area (Max.)		35mm ²	35mm ²
For mounting on	35mm Din rail		
Enclosure material	Thermoplastic UL94-V0		
Degree of protection	IP20	IP20	IP20
Order Code	B7412	B7414	B7416
Order Code (With remote signaling)	B7413	B7415	B7417

BR-200 2P

Type 2 Surge Arrester

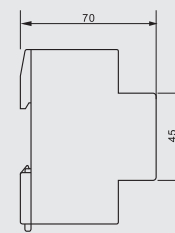
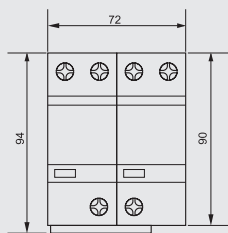
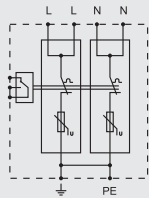

■ BR-200 2pole surge arrester is suitable for TN-S system.

	BR-200 275 2P	BR-200 320 2P	BR-200 385 2P
SPD classification according to EN61643-11	Type 2	Type 2	Type 2
SPD classification according to IEC61643-11	Class II	Class II	Class II
Max. continuous operating a.c. voltage	Uc	275V	320V
Nominal discharge current (8/20μs)	In	100kA	100kA
Max. discharge current (8/20μs)	Imax	200kA	200kA
Voltage protection level	Up	≤1.9kV	≤2.1kV
Voltage protection level 5kA	Up	≤0.6kV	≤1kV
Max. backup fuse		350A gG	350A gG
Short-circuit withstand capacity	IscCR	25kA	25kA
Temporary overvoltage TOV-withstand	UT	335V/5sec.	400V/5sec.
Temporary overvoltage TOV-safe failure	UT	440V/120min.	520V/120min.
Response time	tA	≤25ns	≤25ns
Operating temperature range	Tu	-40°C-80°C	-40°C-80°C
Operating state/fault indication		green/red	green/red
Cross-section area (Min.)		4 mm ²	4 mm ²
Cross-section area (Max.)		35mm ²	35mm ²
For mounting on	35mm Din rail		
Enclosure material	Thermoplastic UL94-V0		
Degree of protection	IP20	IP20	IP20
Order Code	B7422	B7424	B7426
Order Code (With remote signaling)	B7423	B7425	B7427

BR-200 1P

Type 2 Surge Arrester

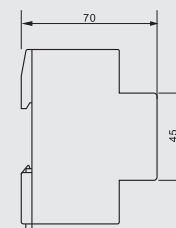
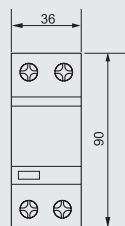
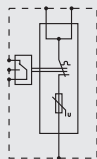

■ BR-200 1pole can form 1-4 poles.

	BR-200 275 1P	BR-200 320 1P	BR-200 385 1P
SPD classification according to EN61643-11	Type 2	Type 2	Type 2
SPD classification according to IEC61643-11	Class II	Class II	Class II
Max. continuous operating a.c. voltage	Uc	275V	320V
Nominal discharge current (8/20µs)	In	100kA	100kA
Max. discharge current (8/20µs)	Imax	200kA	200kA
Voltage protection level	Up	≤1.9kV	≤2.1kV
Voltage protection level 5kA	Up	≤0.6kV	≤1kV
Max. backup fuse		350A gG	350A gG
Short-circuit withstand capacity	IscCR	25kA	25kA
Temporary overvoltage TOV-withstand	UT	335V/5sec.	400V/5sec.
Temporary overvoltage TOV-safe failure	UT	440V/120min.	520V/120min.
Response time	tA	≤25ns	≤25ns
Operating temperature range	Tu	-40°C-80°C	-40°C-80°C
Operating state/fault indication		green/red	green/red
Cross-section area (Min.)		4 mm ²	4 mm ²
Cross-section area (Max.)		35mm ²	35mm ²
For mounting on	35mm Din rail		
Enclosure material	Thermoplastic UL94-V0		
Degree of protection	IP20	IP20	IP20
Order Code	B7432	B7434	B7436
Order Code (With remote signaling)	B7433	B7435	B7437

BR-200 3+1

Type 2 Surge Arrester

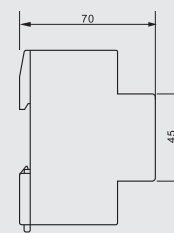
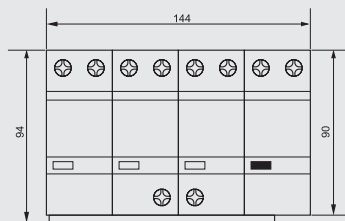
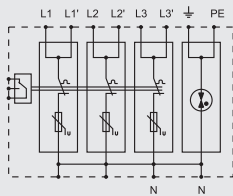

■ BR-200 3+1 surge arrester is suitable for TT and TN-S system.

	BR-200 275 3+1	BR-200 320 3+1	BR-200 385 3+1
SPD classification according to EN61643-11	Type 2	Type 2	Type 2
SPD classification according to IEC61643-11	Class II	Class II	Class II
Max. continuous operating a.c. voltage [L-N] U _c	275V	320V	385V
Max. continuous operating a.c. voltage [N-PE] U _c	255V	255V	255V
Nominal discharge current (8/20μs) I _n	100kA	100kA	100kA
Max. discharge current (8/20μs) I _{max}	200kA	200kA	200kA
Voltage protection level [L-N] U _p	≤1.9kV	≤2.1kV	≤2.5kV
Voltage protection level 5kA [L-N] U _p	≤0.6kV	≤1kV	≤1.2kV
Voltage protection level [N-PE] U _p	≤1.5kV	≤1.5kV	≤1.5kV
Short-circuit withstand capacity I _{SCCR}	25kA	25kA	25kA
Temporary overvoltage TOV-withstand [L-N] U _T	335V/5sec.	400V/5sec.	500V/5sec.
Temporary overvoltage TOV-safe failure [L-N] U _T	440V/120min.	520V/120min.	650V/120min.
Temporary overvoltage TOV-withstand [N-PE] U _T	1200V/200ms	1200V/200ms	1200V/200ms
Follow current extinguishing capability a.c. [N-PE] I _{fi}	100Arms	100Arms	100Arms
Max. backup fuse	350A gG	350A gG	350A gG
Response time [L-N] t _A	≤25ns	≤25ns	≤25ns
Response time [N-PE] t _A	≤100ns	≤100ns	≤100ns
Operating temperature range T _u	-40°C-80°C	-40°C-80°C	-40°C-80°C
Operating state/fault indication	green/red	green/red	green/red
Cross-section area (Min.)	4 mm ²	4 mm ²	4 mm ²
Cross-section area (Max.)	35mm ²	35mm ²	35mm ²
For mounting on	35mm Din rail		
Enclosure material	Thermoplastic UL94-V0		
Degree of protection	IP20	IP20	IP20
Order Code	B7442	B7444	B7446
Order Code (With remote signaling)	B7443	B7445	B7447

BR-200 1+1

Type 2 Surge Arrester

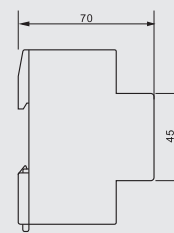
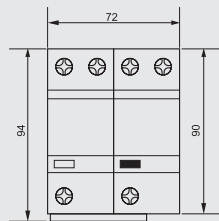
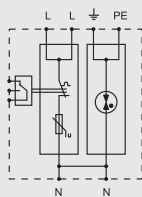

■ BR-200 1+1 surge arrester is suitable for TT and TN-S system.

	BR-200 275 1+1	BR-200 320 1+1	BR-200 385 1+1
SPD classification according to EN61643-11	Type 2	Type 2	Type 2
SPD classification according to IEC61643-11	Class II	Class II	Class II
Max. continuous operating a.c. voltage [L-N] U _c	275V	320V	385V
Max. continuous operating a.c. voltage [N-PE] U _c	255V	255V	255V
Nominal discharge current (8/20μs) I _n	100kA	100kA	100kA
Max. discharge current (8/20μs) I _{max}	200kA	200kA	200kA
Voltage protection level [L-N] U _p	≤1.9kV	≤2.1kV	≤2.5kV
Voltage protection level 5kA [L-N] U _p	≤0.6kV	≤1kV	≤1.2kV
Voltage protection level [N-PE] U _p	≤1.5kV	≤1.5kV	≤1.5kV
Short-circuit withstand capacity I _{SCCR}	25kA	25kA	25kA
Temporary overvoltage TOV-withstand [L-N] U _T	335V/5sec.	400V/5sec.	500V/5sec.
Temporary overvoltage TOV-safe failure [L-N] U _T	440V/120min.	520V/120min.	650V/120min.
Temporary overvoltage TOV-withstand [N-PE] U _T	1200V/200ms	1200V/200ms	1200V/200ms
Follow current extinguishing capability a.c. [N-PE] I _{fi}	100Arms	100Arms	100Arms
Max. backup fuse	350A gG	350A gG	350A gG
Response time [L-N] t _A	≤25ns	≤25ns	≤25ns
Response time [N-PE] t _A	≤100ns	≤100ns	≤100ns
Operating temperature range T _u	-40°C-80°C	-40°C-80°C	-40°C-80°C
Operating state/fault indication	green/red	green/red	green/red
Cross-section area (Min.)	4 mm ²	4 mm ²	4 mm ²
Cross-section area (Max.)	35mm ²	35mm ²	35mm ²
For mounting on	35mm Din rail		
Enclosure material	Thermoplastic UL94-V0		
Degree of protection	IP20	IP20	IP20
Order Code	B7452	B7454	B7456
Order Code (With remote signaling)	B7453	B7455	B7457



Type 2+3 Surge Arrester

www.britecelectric.com

BR-40DP

Type 2+3 Surge Arrester

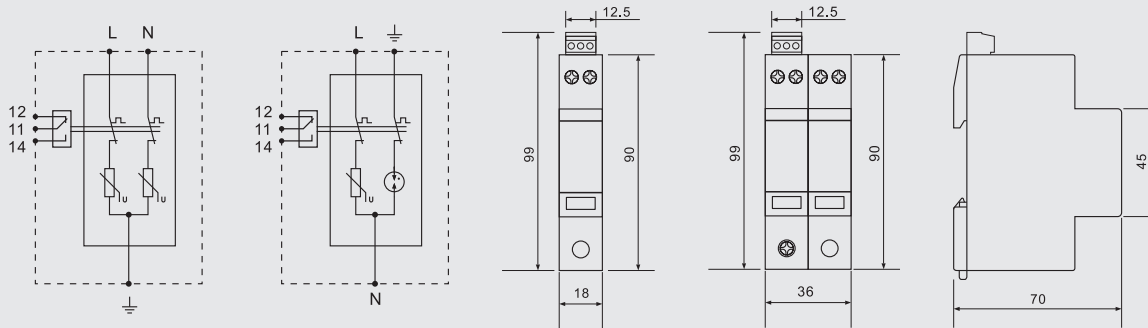
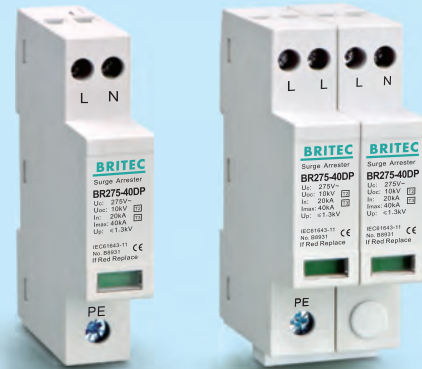

- Type 2+Type 3 surge arrester is installed between LPZ1 and LPZ2, it can provide type 3 protection for equipments which installed within 5 meters from these devices.

	BR 275 40DP 4	BR 275 40DP 2	BR 275 40DP 3+1	BR 275 40DP 1+1
SPD classification according to EN61643-11	Type 2+Type 3	Type 2+Type 3	Type 2+Type 3	Type 2+Type 3
SPD classification according to IEC61643-11	Class II+Class III	Class II+Class III	Class II+Class III	Class II+Class III
Max. continuous operating a.c. voltage	Uc	275V	275V	275V
Nominal discharge current (8/20 μs)	In	20kA	20kA	20kA
Max. discharge current (8/20 μs)	Imax	40kA	40kA	40kA
Voltage protection level	Up	≤1.3kV	≤1.3kV	≤1.3kV/1.5kV
Voltage protection level 5kA	Up	≤1.0kV	≤1.0kV	≤1.0kV/1.5kV
Combined impulse	Uoc	10kV	10kV	10kV
Max backup fuse		125A gG	125A gG	125A gG
Response time	tA	≤25ns	≤25ns	≤25ns
Operating temperature range	Tu	-40°C-80°C	-40°C-80°C	-40°C-80°C
Operating state/fault indication		green/red	green/red	green/red
Cross-section area (Min.)		2.5mm ²	2.5mm ²	2.5mm ²
Cross-section area (Max.)		16mm ²	16mm ²	16mm ²
For mounting on	35mm Din rail			
Enclosure material	Thermoplastic UL94-V0			
Degree of protection	IP20	IP20	IP20	IP20
Order Code	B8220	B8241	B8243	B8245
Order Code (with remote signal)	B8221	B8242	B8244	B8246



Type 3 Surge Arrester

www.britecelectric.com

BR-20DP

Type 3 Surge Arrester

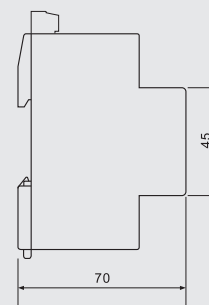
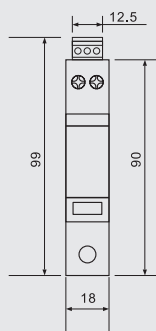
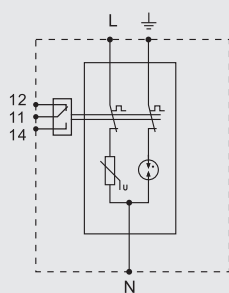
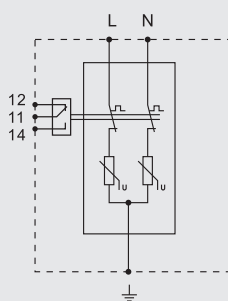

■ Type 3 surge arrester is installed between LPZ2 and LPZ3, it can provide protection for equipments.

	BR30-20DP	BR75-20DP	BR150-20DP	BR275-20DP
SPD classification according to EN61643-11	Type 3	Type 3	Type 3	Type 3
SPD classification according to IEC61643-11	Class III	Class III	Class III	Class III
Normal a.c. voltage U_n	24V	60V	120V	230V
Max. continuous operating a.c. voltage U_c	30V	75V	150V	275V
Max. continuous operating d.c. voltage U_c	38V	100V	190V	300V
Nominal discharge current (8/20 μ s) I_n	10kA	10kA	10kA	10kA
Combined impulse U_{oc}	10kV	10kV	10kV	10kV
Voltage protection level U_p	≤ 300 V	≤ 600 V	≤ 800 V	≤ 1200 V
Response time t_A	≤ 25 ns	≤ 25 ns	≤ 25 ns	≤ 25 ns
Operating temperature range T_u	-40°C-80°C	-40°C-80°C	-40°C-80°C	-40°C-80°C
Operating state/fault indication	green/red	green/red	green/red	green/red
Cross-section area (Min.)	2.5mm ²	2.5mm ²	2.5mm ²	2.5mm ²
Cross-section area (Max.)	16mm ²	16mm ²	16mm ²	16mm ²
For mounting on	35mm Din rail	35mm Din rail	35mm Din rail	35mm Din rail
Enclosure material	Thermoplastic UL94-V0			
Degree of protection	IP20	IP20	IP20	IP20
Order Code 2P	B8345	B8343	B8341	B8339
Order Code (with remote signal) 2P	B8346	B8344	B8342	B8340
Order Code 1+1	B8353	B8351	B8349	B8347
Order Code (with remote signal) 1+1	B8354	B8352	B8350	B8348

BR-10DP

Type 3 Surge Arrester

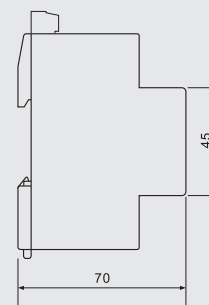
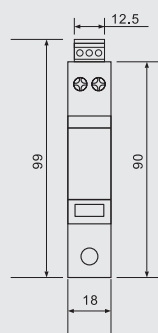
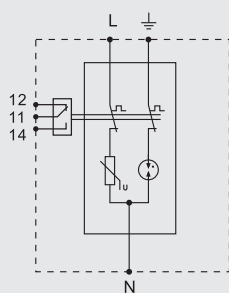
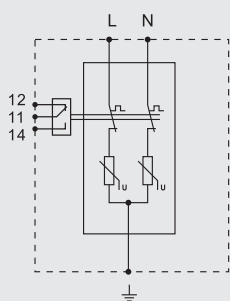

■ Type 3 surge arrester is installed between LPZ2 and LPZ3, it can provide protection for equipments.

	BR30-10DP	BR75-10DP	BR150-10DP	BR275-10DP
SPD classification according to EN61643-11	Type 3	Type 3	Type 3	Type 3
SPD classification according to IEC61643-11	Class III	Class III	Class III	Class III
Normal a.c. voltage	Un	24V	60V	120V
Max. continuous operating a.c. voltage	Uc	30V	75V	150V
Max. continuous operating d.c. voltage	Uc	38V	100V	190V
Nominal discharge current (8/20 μ s)	In	5kA	5kA	5kA
Combined impulse	Uoc	10kV	10kV	10kV
Voltage protection level	Up	≤ 200 V	≤ 500 V	≤ 700 V
Response time	tA	≤ 25 ns	≤ 25 ns	≤ 25 ns
Operating temperature range	Tu	-40°C-80°C	-40°C-80°C	-40°C-80°C
Operating state/fault indication		green/red	green/red	green/red
Cross-section area (Min.)		2.5mm ²	2.5mm ²	2.5mm ²
Cross-section area (Max.)		16mm ²	16mm ²	16mm ²
For mounting on		35mm Din rail	35mm Din rail	35mm Din rail
Enclosure material	Thermoplastic UL94-V0			
Degree of protection		IP20	IP20	IP20
Order Code	2P	B8237	B8235	B8359
Order Code (with remote signal)	2P	B8238	B8236	B8234
Order Code	1+1	B8337	B8335	B8333
Order Code (with remote signal)	1+1	B8338	B8336	B8334

BR275-6

Type 3 Surge Arrester

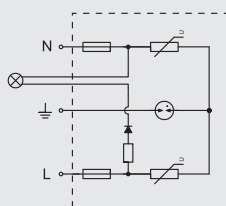

BR275-6-L

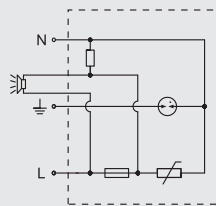
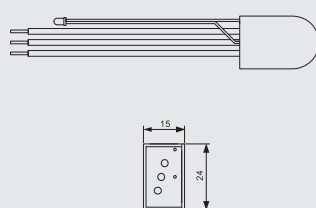

BR275-6-B

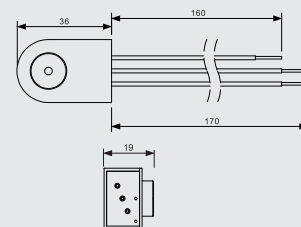

■ Type 3 surge arrester is installed between LPZ2 and LPZ3, it can provide protection for equipments.

		BR275-6-L	BR275-6-B
SPD classification according to EN61643-11		Type 3	Type 3
SPD classification according to IEC61643-11		Class III	Class III
Normal a.c. voltage	Un	230V	230V
Max. continuous operating a.c. voltage	Uc	275V	275V
Max. continuous operating d.c. voltage	Uc	300V	300V
Nominal discharge current (8/20 μs)	In	3kA	3kA
Combined impulse	Uoc	6kV	6kV
Voltage protection level	Up	≤ 1.3kV	≤ 1.3kV
Response time	tA	≤ 25ns	≤ 25ns
Operating temperature range	Tu	-40°C-80°C	-40°C-80°C
Operating state/fault indication		LED	BEEP
For mounting on		35mm Din rail	35mm Din rail
Enclosure material		Thermoplastic UL94-V0	Thermoplastic UL94-V0
Degree of protection		IP20	IP20
Order Code		B8355	B8357

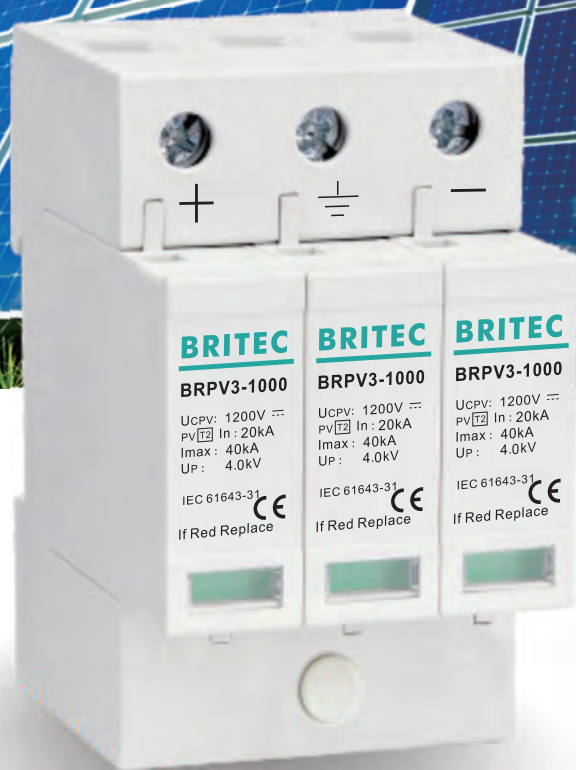

BRITEC

BRPV3-1000

UCPV: 1200V $\overline{\text{---}}$
PV \square In: 20kA
Imax: 40kA
Up: 4.0kV

IEC 61643-31 **CE**
If Red Replace

BRITEC

BRPV3-1000

UCPV: 1200V $\overline{\text{---}}$
PV \square In: 20kA
Imax: 40kA
Up: 4.0kV

IEC 61643-31 **CE**
If Red Replace

BRITEC

BRPV3-1000

UCPV: 1200V $\overline{\text{---}}$
PV \square In: 20kA
Imax: 40kA
Up: 4.0kV

IEC 61643-31 **CE**
If Red Replace

DC Surge Arrester for pv

www.britecelectric.com

BRPV3 T1

Type 1+2 DC Surge Arrester for PV

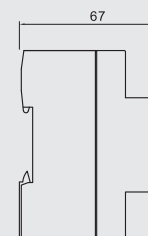
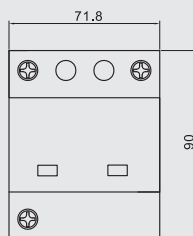
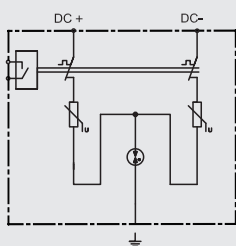

		BRPV3 600T1	BRPV3 1000T1
SPD classification according to EN61643-31 / IEC61643-31		Type 1 + Type 2 / Class I + Class II	
Max. continuous operating dc voltage	Ucpv	600V	1000V
Lightning impulse current (10/350 μs)	Iimp	12.5kA	12.5kA
Nominal discharge current (8/20 μs)	In	20kA	20kA
Max. discharge current (8/20 μs)	I _{max}	50kA	50kA
Voltage protection level [(DC+/DC-)→PE]	Up	≤ 2.6kV	≤ 4.0kV
Response time	t _A	≤ 25ns	≤ 25ns
Operating temperature range	T _u	-40°C -80°C	-40°C -80°C
Operating state/fault indication		green/red	green/red
Cross-section area (Min.)		4mm ²	4mm ²
Cross-section area (Max.)		35mm ²	35mm ²
For mounting on		35mm Din rail	35mm Din rail
Enclosure material		Thermoplastic UL94-V0	
Degree of protection		IP20	IP20
Order Code		B8001	B8002
Order code (With remote signal)		B8003	B8004

BRPV3

Type 2 DC Surge Arrester for PV

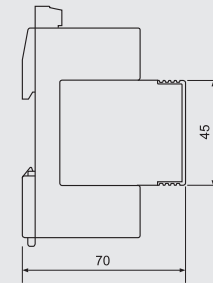
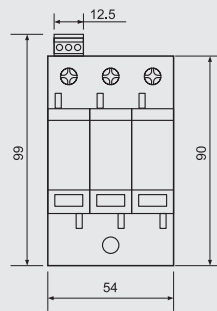
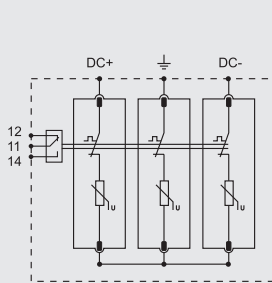
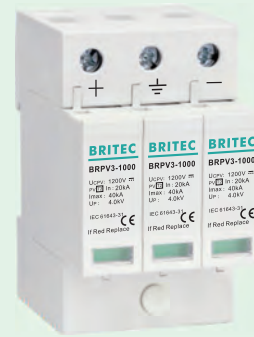

3 Mod		BRPV3 600	BRPV3 1000	BRPV3 1500
SPD classification according to EN61643-31 / IEC61643-31		Type 2 / Class II	Type 2 / Class II	Type 2 / Class II
Max. continuous operating dc voltage	Ucpv	600V	1200V	1500V
Nominal discharge current (8/20 μs)	In	20kA	20kA	20kA
Max. discharge current (8/20 μs)	Imax	40kA	40kA	40kA
Voltage protection level [(DC+/DC-)→PE]	Up	≤ 2.2kV	≤ 4.0kV	≤ 5.2kV
Response time	tA	≤ 25ns	≤ 25ns	≤ 25ns
Operating temperature range	Tu	-40°C -80°C	-40°C -80°C	-40°C -80°C
Operating state/fault indication		green/red	green/red	green/red
Cross-section area (Min.)		4mm ²	4mm ²	4mm ²
Cross-section area (Max.)		35mm ²	35mm ²	35mm ²
For mounting on		35mm Din rail	35mm Din rail	35mm Din rail
Enclosure material		Thermoplastic UL94-V0	Thermoplastic UL94-V0	Thermoplastic UL94-V0
Degree of protection		IP20	IP20	IP20
Order Code		B8009	B8010	B8018
Order code (With remote signal)		B8011	B8012	B8019

BRPV3GD

Type 2 DC Surge Arrester for PV

* No leakage current

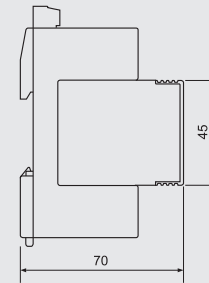
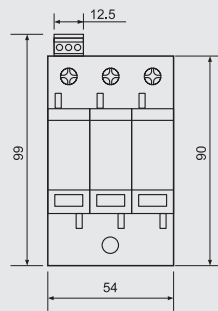
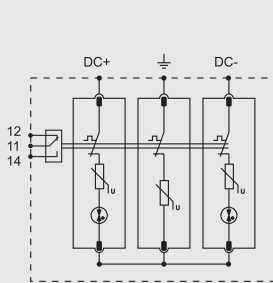

3 Mod free leakage current		BRPV3 600 GD	BRPV3 1000 GD
SPD classification according to EN61643-31 / IEC61643-31		Type 2 / Class II	Type 2 / Class II
Max. continuous operating dc voltage	Ucpv	600V	1200V
Nominal discharge current (8/20 μs)	In	20kA	20kA
Max. discharge current (8/20 μs)	I _{max}	40kA	40kA
Voltage protection level [(DC+/DC-)→PE]	Up	≤ 2.2kV	≤ 4.0kV
Response time	t _A	≤ 100ns	≤ 100ns
Operating temperature range	T _u	-40°C -80°C	-40°C -80°C
Operating state/fault indication		green/red	green/red
Cross-section area (Min.)		4mm ²	4mm ²
Cross-section area (Max.)		35mm ²	35mm ²
For mounting on		35mm Din rail	35mm Din rail
Enclosure material		Thermoplastic UL94-V0	Thermoplastic UL94-V0
Degree of protection		IP20	IP20
Order Code		B8005	B8006
Order code (With remote signal)		B8007	B8008

BRPV2

Type 2 DC Surge Arrester

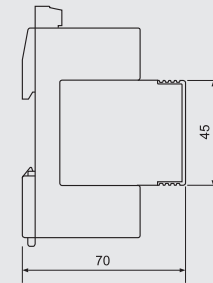
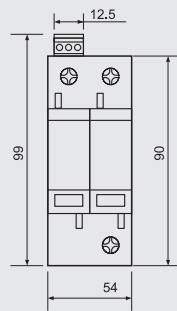
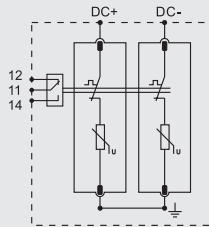

2 Mod		BRPV2 600
SPD classification according to EN61643-31 / IEC61643-31		Type 2 / Class II
Max. continuous operating dc voltage	Ucpv	≤ 600V
Nominal discharge current (8/20μs)	In	20kA
Max. discharge current (8/20 μ. s)	Imax	40kA
Voltage protection level	Up	≤ 2.2kV
Response time	tA	≤ 25ns
Operating temperature range	Tu	-40°C -80°C
Operating state/fault indication		green/red
Cross-section area (Min.)		4mm ²
Cross-section area (Max.)		35mm ²
For mounting on		35mm Din rail
Enclosure material		Thermoplastic UL94-V0
Degree of protection		IP20
Order Code		B8013
Order code (With remote signal)		B8015



SPD for Data Protection

SPDs for general information (plug-in) BRPI-2L

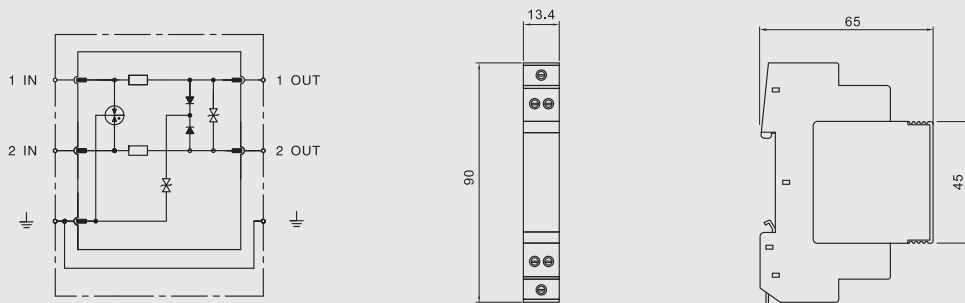

		BRPI-2L-6	BRPI-2L-12	BRPI-2L-24	BRPI-2L-48	BRPI-2L-60	BRPI-2L-180
Test standards		IEC 61643-21	IEC 61643-21	IEC 61643-21	IEC 61643-21	IEC 61643-21	IEC 61643-21
Nominal voltage	Un	6V	12V	24V	48V	60V	180V
Max. continuous operating d.c. voltage	Uc	8V	15V	29V	56V	70V	180V
Max. continuous operating a.c. voltage	Uc	5V	11V	20V	40V	49V	130V
Nominal current	IL	0.5A	0.5A	0.5A	0.5A	0.5A	0.5A
C2 Nominal discharge current(8/20µs) per line	In	5kA	5kA	5kA	5kA	5kA	5kA
Voltage protection level [line–line]	Up	≤30V	≤40V	≤60V	≤100V	≤130V	≤320V
Voltage protection level [line–PG]	Up	≤600V	≤600V	≤600V	≤600V	≤600V	≤600V
Response time [line–line]	tA	≤1ns	≤1ns	≤1ns	≤1ns	≤1ns	≤1ns
Response time [line–PG]	tA	≤100ns	≤100ns	≤100ns	≤100ns	≤100ns	≤100ns
Operating temperature range	TU	–40°C...+80°C	–40°C...+80°C	–40°C...+80°C	–40°C...+80°C	–40°C...+80°C	–40°C...+80°C
Connection input/output		Terminal Block	Terminal Block	Terminal Block	Terminal Block	Terminal Block	Terminal Block
Bandwidth		10 Mbps	10 Mbps	10 Mbps	10 Mbps	10 Mbps	10 Mbps
Insertion Loss		≤0.3dB	≤0.3dB	≤0.3dB	≤0.3dB	≤0.3dB	≤0.3dB
Enclosure material		Thermoplastic UL94-V0					
Degree of protection		IP20	IP20	IP20	IP20	IP20	IP20
Order Code		D9100	D9101	D9102	D9103	D9104	D9105

SPDs for general information (plug-in) BR BD 4L

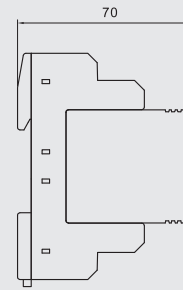
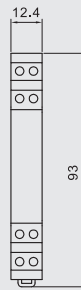
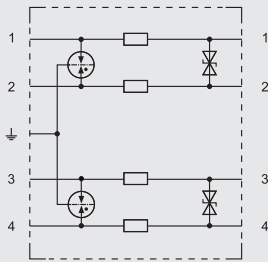

	BR BD 4L-6	BR BD 4L-12	BR BD 4L-24	BR BD 4L-48	BR BD 4L-60	BR BD 4L-180	
Test standards	IEC 61643-21	IEC 61643-21	IEC 61643-21	IEC 61643-21	IEC 61643-21	IEC 61643-21	
SPD class	TYPE2 P1	TYPE2 P1	TYPE2 P1	TYPE2 P1	TYPE2 P1	TYPE2 P1	
Nominal voltage	Un	5V	12V	24V	48V	60V	180V
Max. continuous operating d.c. voltage	Uc	6.0V	15V	33V	54V	70V	180V
Max. continuous operating a.c. voltage	Uc	4.2V	10.6V	23.3V	38.1V	49.5V	127V
Nominal current at 45°C	IL	1A	1A	1A	1A	1A	0.75A
C2 Total nominal discharge current (8/20µs)	In	20kA	20kA	20kA	20kA	20kA	20kA
C2 Nominal discharge current (8/20µs) per line	In	10kA	10kA	10kA	10kA	10kA	10kA
Voltage protection level line–line for In C2	Up	≤15V	≤27V	≤55V	≤85V	≤110V	≤270V
Voltage protection level line–PG for In C2	Up	≤600V	≤600V	≤600V	≤600V	≤600V	≤600V
Voltage protection level line–line at 1 kV/µs C3	Up	≤9V	≤19V	≤45V	≤70V	≤90V	≤250V
Voltage protection level line–PG at 1 kV/µs C3	Up	≤550V	≤550V	≤550V	≤550V	≤550V	≤550V
Series impedance per line		1 Ohm	1 Ohm	1 Ohm	1 Ohm	1 Ohm	1.8 Ohm
Cut-off frequency line–PG	fG	1.0 MHz	2.8 MHz	7.8 MHz	8.7 MHz	11.0 MHz	25.0 MHz
Capacitance line–line	C	≤5.4 nF	≤2.0 nF	≤1.0 nF	≤0.7nF	≤500pF	≤240pF
capacitance line–PG	C	≤16 pF	≤16 pF	≤16 pF	≤16 pF	≤16 pF	≤16 pF
Operating temperature range	Tu	−40°C...+80°C	−40°C...+80°C	−40°C...+80°C	−40°C...+80°C	−40°C...+80°C	−40°C...+80°C
Enclosure material	polyamide PA 6.6						
Degree of protection (plugged-in)	IP 20	IP 20	IP 20	IP 20	IP 20	IP 20	
Order Code	D9110	D9111	D9112	D9113	D9114	D9115	



SPDs for general information(plug-in)

BR BE 4L

High degree of protection for four single lines

For installation in conformity with the lightning protection zone concept at the boundaries from 0B-2 and higher

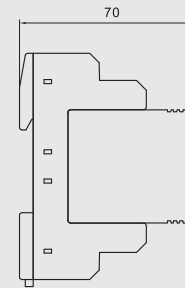
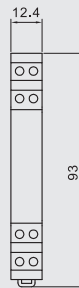
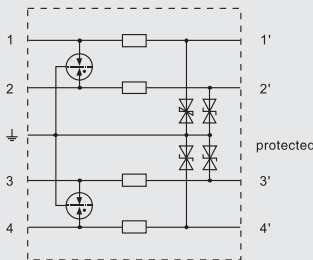

	BR BE 4L-6	BR BE 4L-12	BR BE 4L-24	BR BE 4L-48	BR BE 4L-60	BR BE 4L-180	
Test standards	IEC 61643-21	IEC 61643-21	IEC 61643-21	IEC 61643-21	IEC 61643-21	IEC 61643-21	
SPD class	TYPE2 P1	TYPE2 P1	TYPE2 P1	TYPE2 P1	TYPE2 P1	TYPE2 P1	
Nominal voltage	Un	5V	12V	24V	48V	60V	180V
Max. continuous operating d.c. voltage	Uc	6.0V	15V	33V	54V	70V	180V
Max. continuous operating a.c. voltage	Uc	4.2V	10.6V	23.3V	38.1V	49.5V	127V
Nominal current at 45°C	IL	1A	0.75A	0.75A	0.75A	1A	1A
C2 Total nominal discharge current (8/20µs)	In	20kA	20kA	20kA	20kA	20kA	20kA
C2 Nominal discharge current (8/20µs) per line	In	10kA	10kA	10kA	10kA	10kA	10kA
Voltage protection level line-line for In C2	Up	≤40V	≤55V	≤105V	≤170V	≤220V	≤550V
Voltage protection level line-PG for In C2	Up	≤60V	≤60V	≤85V	≤115V	≤155V	≤300V
Voltage protection level line-line at 1 kV/µs C3	Up	≤18V	≤38V	≤90V	≤140V	≤180V	≤500V
Voltage protection level line-PG at 1 kV/µs C3	Up	≤9V	≤19V	≤45V	≤70V	≤90V	≤250V
Series impedance per line		1 Ohm	1.8 Ohm	1.8 Ohm	1.8 Ohm	1 Ohm	1 Ohm
Cut-off frequency line-PG	fG	1.0 MHz	2.7 MHz	6.8 MHz	8.7 MHz	9.0 MHz	25.0 MHz
Capacitance line-line	C	≤2.7 nF	≤1.0 nF	≤0.5 nF	≤0.35 nF	≤250 pF	≤120 pF
capacitance line-PG	C	≤5.4 nF	≤2.0nF	≤1.0nF	≤0.7nF	≤500 pF	≤240 pF
Operating temperature range	Tu	-40°C...+80°C	-40°C...+80°C	-40°C...+80°C	-40°C...+80°C	-40°C...+80°C	-40°C...+80°C
Enclosure material	polyamide PA 6.6						
Degree of protection (plugged-in)	IP 20	IP 20	IP 20	IP 20	IP 20	IP 20	
Order Code	D9116	D9117	D9118	D9119	D9120	D9121	

SPDs for general BR-ME

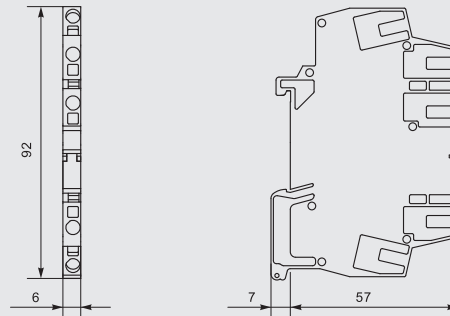
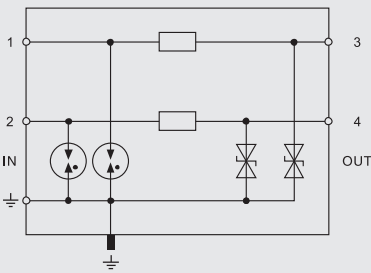

	BR-ME-12	BR-ME-24	BR-ME-48	BR-ME-110	
Test standards	IEC 61643-21	IEC 61643-21	IEC 61643-21	IEC 61643-21	
SPD class	TYPE2 P1	TYPE2 P1	TYPE2 P1	TYPE2 P1	
Nominal voltage	Un	12V	24V	48V	110V
Max. continuous operating d.c. voltage	Uc	14V	33V	55V	170V
Max. continuous operating a.c. voltage	Uc	9.5V	23V	38.5V	120V
Nominal current at 45°C	IL	0.5A	0.5A	0.5A	0.5A
C2 Total nominal discharge current (8/20µs)	In	10kA	10kA	10kA	10kA
C2 Nominal discharge current (8/20µs) per line	In	5kA	5kA	5kA	5kA
Voltage protection level line–line for In C2	Up	≤55V	≤110V	≤175V	≤500V
Voltage protection level line–PG for In C2	Up	≤40V	≤65V	≤100V	≤270V
Voltage protection level line–line at 1 kV/µs C3	Up	≤36V	≤90V	≤160V	≤460V
Voltage protection level line–PG at 1 kV/µs C3	Up	≤19V	≤45V	≤80V	≤230V
Series impedance per line		1.8 Ohm	1.8 Ohm	1.8 Ohm	1.8 Ohm
Cut-off frequency line–PG	fG	2.5 MHz	6 MHz	10 MHz	16 MHz
Capacitance line–line	C	< 1.2 nF	< 0.5 nF	< 0.3 nF	< 0.2 nF
capacitance line–PG	C	< 2.4 nF	< 1.0 nF	< 0.6 nF	< 0.4 nF
Operating temperature range	Tu	–40°C...+80°C	–40°C...+80°C	–40°C...+80°C	–40°C...+80°C
Cross section of cable		0.08–2.5mm ²	0.08–2.5mm ²	0.08–2.5mm ²	0.08–2.5mm ²
Enclosure material	polyamide PA 6.6				
Degree of protection (plugged-in)		IP 20	IP 20	IP 20	IP 20
Order Code		D9131	D9132	D9133	D9134

SPDs for general BR-MD

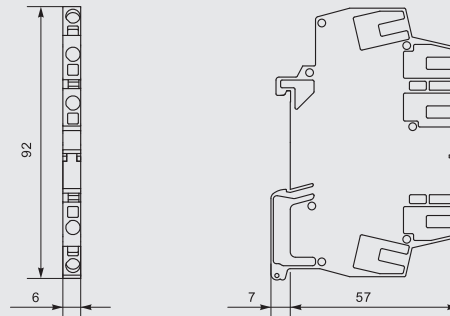
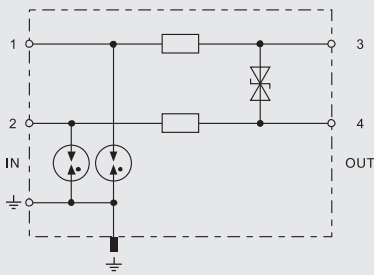

	BR-MD-12	BR-MD-24	BR-MD-48	BR-MD-110	
Test standards	IEC 61643-21	IEC 61643-21	IEC 61643-21	IEC 61643-21	
SPD class	TYPE2 P1	TYPE2 P1	TYPE2 P1	TYPE2 P1	
Nominal voltage	Un	12V	24V	48V	110V
Max. continuous operating d.c. voltage	Uc	14V	33V	55V	170V
Max. continuous operating a.c. voltage	Uc	9.5V	23V	38.5V	120V
Nominal current at 45°C	IL	0.5A	0.5A	1.7A	0.5A
C2 Total nominal discharge current (8/20µs)	In	10kA	10kA	10kA	10kA
C2 Nominal discharge current (8/20µs) per line	In	5kA	5kA	5kA	5kA
Voltage protection level line–line for In C2	Up	≤25V	≤50V	≤100V	≤260V
Voltage protection level line–PG for In C2	Up	≤750V	≤750V	≤750V	≤750V
Voltage protection level line–line at 1 kV/µs C3	Up	≤19V	≤45V	≤70V	≤230V
Voltage protection level line–PG at 1 kV/µs C3	Up	≤650V	≤650V	≤650V	≤650V
Series impedance per line		1.8 Ohm	1.8 Ohm	1.8 Ohm	1.8 Ohm
Cut-off frequency line–PG	fG	2.5 MHz	6 MHz	10 MHz	16 MHz
Capacitance line–line	C	≤2.4 nF	≤1 nF	<0.6 nF	<0.4 nF
capacitance line–PG	C	≤5 pF	≤5 pF	<10 pF	<5 pF
Operating temperature range	Tu	–40°C...+80°C	–40°C...+80°C	–40°C...+80°C	–40°C...+80°C
Cross section of cable		0.08–2.5mm ²	0.08–2.5mm ²	0.08–2.5mm ²	0.08–2.5mm ²
Enclosure material	polyamide PA 6.6				
Degree of protection (plugged-in)		IP 20	IP 20	IP 20	IP 20
Order Code		D9151	D9152	D9153	D9154

SPDs for general BR-POE

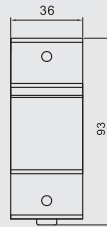
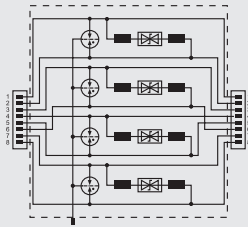

BR-POE-P

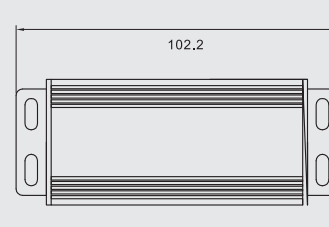

BR-POE-M

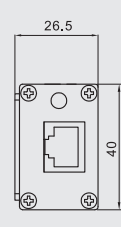

		BR-POE-M	BR-POE-P
Test standards		IEC 61643-21	IEC 61643-21
SPD class		TYPE2 P1	TYPE2 P1
Nominal voltage	Un	48V	48V
Max. continuous operating d.c. voltage	Uc	48V	48V
Max. continuous operating a.c. voltage	Uc	34V	34V
Max. continuous operating d.c. voltage pair-pair(PoE)	Uc	57V	57V
Nominal current	IL	1A	1A
D1 Lightning impulse current (10/350 μs) per line	Iimp	0.5kA	0.5kA
C2 Nominal discharge current (8/20μs) line-line	In	150A	150A
C2 Nominal discharge current (8/20μs) line-PG	In	2.5kA	2.5kA
C2 Total nominal discharge current (8/20μs) line-PG	In	10kA	10kA
C2 Nominal discharge current (8/20μs) pair-pair(PoE)	In	150A	150A
Voltage protection level pair-pair for In C2	Up	≤ 180V	≤ 180V
Voltage protection level line-PG for In C2	Up	≤ 500V	≤ 500V
Voltage protection level line-line for In C2(PoE)	Up	≤ 600V	≤ 600V
Insertion loss at 250 MHz		≤ 3 dB	≤ 3 dB
Capacitance line-line	C	≤ 30 pF	≤ 30 pF
capacitance line-PG	C	≤ 25 pF	≤ 25 pF
Operating temperature range	Tu	-40°C...+80°C	-40°C...+80°C
For mounting on		35mm DIN rails acc. to EN 60715	35mm DIN rails acc. to EN 60715
Connection (input/output)		RJ45 socket/RJ45 socket	RJ45 socket/RJ45 socket
Pinning		1/2, 3/6, 4/5, 7/8	1/2, 3/6, 4/5, 7/8
Earthing via		35mm DIN rails acc. to EN 60715	35mm DIN rails acc. to EN 60715
Enclosure material		aluminium alloy	polyamide PA 6.6
Degree of protection (plugged-in)		IP 10	IP 10
Order Code		D9160	D9161



SPDs for general information BRGI-2L

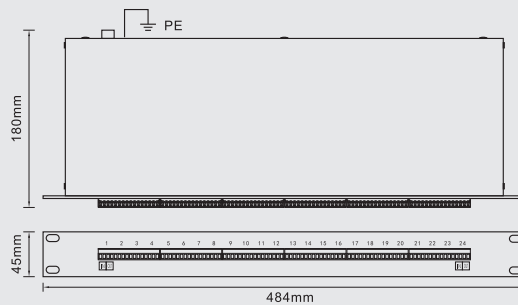
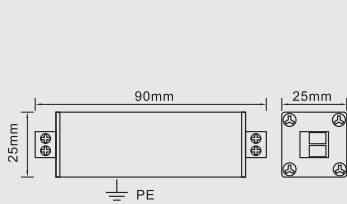
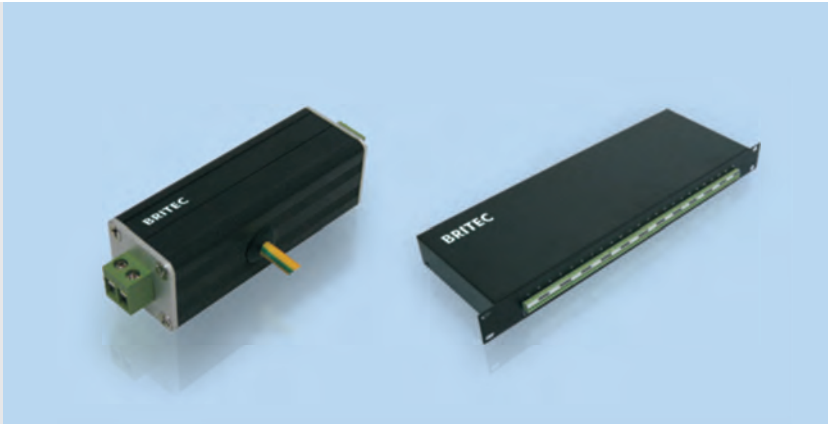

		BRGI-2L-6	BRGI-2L-12	BRGI-2L-24	BRGI-2L-48	BRGI-2L-60	BRGI-2L-180
Test standards		IEC 61643-21	IEC 61643-21	IEC 61643-21	IEC 61643-21	IEC 61643-21	IEC 61643-21
Nominal voltage	Un	6V	12V	24V	48V	60V	180V
Max. continuous operating d.c. voltage	Uc	8V	15V	29V	56V	70V	180V
Max. continuous operating a.c. voltage	Uc	5V	11V	20V	40V	49V	130V
Nominal current	IL	0.5A	0.5A	0.5A	0.5A	0.5A	0.5A
C2 Nominal discharge current(8/20µs) per line	In	5kA	5kA	5kA	5kA	5kA	5kA
Voltage protection level [line–line]	Up	≤30V	≤40V	≤60V	≤100V	≤130V	≤320V
Voltage protection level [line–PG]	Up	≤600V	≤600V	≤600V	≤600V	≤600V	≤600V
Response time [line–line]	tA	≤1ns	≤1ns	≤1ns	≤1ns	≤1ns	≤1ns
Response time [line–PG]	tA	≤100ns	≤100ns	≤100ns	≤100ns	≤100ns	≤100ns
Operating temperature range	TU	-40°C...+80°C	-40°C...+80°C	-40°C...+80°C	-40°C...+80°C	-40°C...+80°C	-40°C...+80°C
Connection input/output		Terminal Block	Terminal Block	Terminal Block	Terminal Block	Terminal Block	Terminal Block
Bandwidth		10 Mbps	10 Mbps	10 Mbps	10 Mbps	10 Mbps	10 Mbps
Insertion Loss		≤0.3dB	≤0.3dB	≤0.3dB	≤0.3dB	≤0.3dB	≤0.3dB
Enclosure material		aluminium alloy					
Degree of protection		IP20	IP20	IP20	IP20	IP20	IP20
Order Code 1port		D9001	D9002	D9003	D9004	D9005	D9006
Order Code 24ports		D9007	D9008	D9009	D9010	D9011	D9012

SPDs for RJ BR-RJ45/RJ11

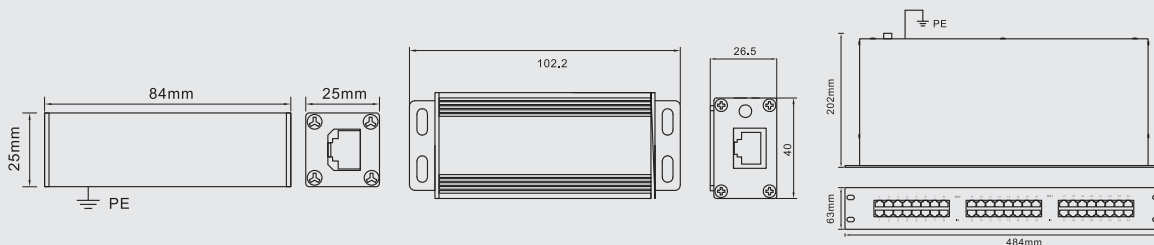

		BRRJ45L-4L	BRRJ45H-8L	BRRJ45L-4LR	BRRJ11L-2L	BRRJ11H-4L
Test standards		IEC 61643-21	IEC 61643-21	IEC 61643-21	IEC 61643-21	IEC 61643-21
Nominal voltage	Un	5V	5V	5V	110V	110V
Max. continuous operating d.c. voltage	Uc	6V	6V	6V	170V	170V
Max. continuous operating a.c. voltage	Uc	4V	4V	4V	120V	120V
Nominal current	IL	0.5A	0.5A	0.5A	0.5A	0.5A
D1 Lightning impulse current (10/350 μs) per line	limp	0.5 kA	0.5 kA	0.5 kA	—	—
C2 Nominal discharge current(8/20μs) per line	In	1.5kA	1.5kA	1.5kA	1.5kA	1.5kA
Voltage protection level [line–line] @200A	Up	≤30V	≤30V	≤30V	≤250V	≤250V
Voltage protection level [line–PG] @1.5kA	Up	≤500V	≤500V	≤500V	≤600V	≤600V
Voltage protection level line-line at 1 kV/μs C3	Up	≤180V	≤180V	≤180V	—	—
Voltage protection level line-PG at 1 kV/μs C3	Up	≤500V	≤500V	≤500V	—	—
Response time [line–line]	tA	≤1ns	≤1ns	≤1ns	≤1ns	≤1ns
Response time [line–PG]	tA	≤100ns	≤100ns	≤100ns	≤100ns	≤100ns
Operating temperature range	TU	–40°C...+80°C	–40°C...+80°C	–40°C...+80°C	–40°C...+80°C	–40°C...+80°C
Connection input/output		RJ45 socket 4 line	RJ45 socket 8 line	RJ45 24 sockets	RJ11 socket 2 line	RJ11 socket 4 line
Bandwidth		30 Mbps	300 Mbps	30 Mbps	10 Mbps	30 Mbps
Insertion Loss		≤0.3dB	≤0.3dB	≤0.3dB	≤0.3dB	≤0.3dB
Enclosure material		aluminium alloy				
Degree of protection		IP20	IP20	IP20	IP20	IP20
Order Code		D9030	D9031	D9032	D9033	D9034

SPDs for Coaxial

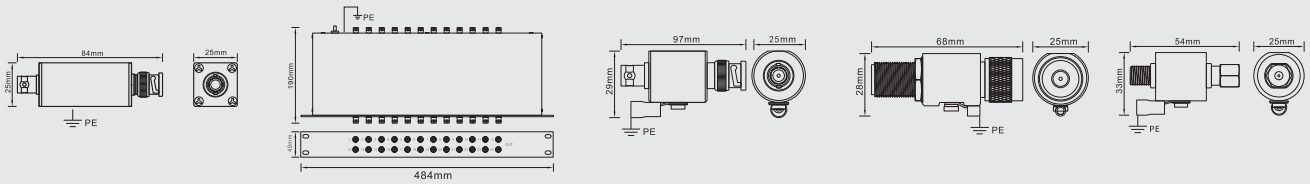

BR-BNC

BR-BNC-R

BR-BNC-H

BR-N

BR-F

	BR-BNC	BR-BNC-R	BR-BNC-H	BR-N	BR-F
Test standards	IEC 61643-21	IEC 61643-21	IEC 61643-21	IEC 61643-21	IEC 61643-21
Nominal voltage	Un	5V	5V	-	-
Max. continuous operating d.c. voltage	Uc	6V	6V	180V	180V
Max. continuous operating a.c. voltage	Uc	4V	4V	130V	130V
Nominal current IL	IL	0.5A	0.5A	20A	20A
C2 Nominal discharge current(8/20µs) line-shield	In	5kA	5kA	-	-
C2 Nominal discharge current(8/20µs) shield-PG	In	10kA	10kA	-	-
C2 Nominal discharge current(8/20µs) line-shield/PG	In	-	-	10kA	10kA
Voltage protection level [line-shield]	Up	≤30V	≤30V	-	-
Voltage protection level [shield-PG]	Up	≤500V	≤500V	-	-
Voltage protection level [line-shield/PG]	Up	-	-	≤800V	≤800V
Response time [line-shield]	tA	≤1ns	≤1ns	-	-
Response time [shield-PG]	tA	≤100ns	≤100ns	-	-
Response time [line-shield/PG]	tA	-	-	≤100ns	≤100ns
Operating temperature range	TU	-40°C...+80°C	-40°C...+80°C	-40°C...+80°C	-40°C...+80°C
Connection input/output	BNC socket	BNC 24 sockets	BNC socket	N socket	F socket
Bandwidth	10 Mbps	10 Mbps	3 Gbps	3 Gbps	3 Gbps
Insertion Loss	≤0.3dB	≤0.3dB	≤0.3dB	≤0.3dB	≤0.3dB
Impedance	50 Ω	50 Ω	50 Ω	50 Ω	50 Ω
Enclosure material	aluminium alloy	aluminium alloy	Steel	Steel	Steel
Degree of protection	IP20	IP20	IP20	IP20	IP20
Order Code	D9020	D9021	D9022	D9023	D9024

SPDs for D-Sub BR-DB

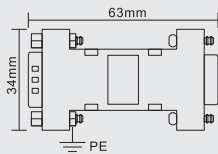

BR-DB9

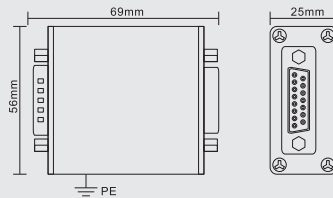

BR-DB15

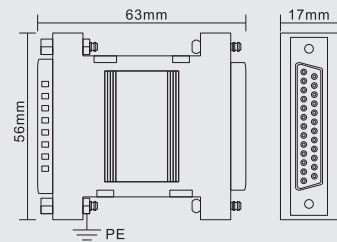

BR-DB25

		BR-DB9	BR-DB15	BR-DB25
Test standards		IEC 61643-21	IEC 61643-21	IEC 61643-21
Nominal voltage	Un	12V	12V	12V
Max. continuous operating d.c. voltage	Uc	15V	15V	15V
C2 Nominal discharge current(8/20µs) line-SG	In	5kA	5kA	5kA
C2 Nominal discharge current(8/20µs) SG-PG	In	10kA	10kA	10kA
Voltage protection level [line-SG]	Up	≤40V	≤40V	≤40V
Voltage protection level [SG-PG]	Up	≤500V	≤500V	≤500V
Response time [line-SG]	tA	≤1ns	≤1ns	≤1ns
Response time [SG-PG]	tA	≤100ns	≤100ns	≤100ns
Operating temperature range	TU	-40°C...+80°C	-40°C...+80°C	-40°C...+80°C
Connection input/output		D-Sub 9 plug/socket	D-Sub 15 plug/socket	D-Sub 25 plug/socket
Pinning		line:3/8, SG:5, PG:1	line:2/9,4/11, SG:8, PG:1	line:2/3/4/5/6/8/20, SG:7
Bandwidth		10 Mbps	10 Mbps	10 Mbps
Insertion Loss		≤0.3dB	≤0.3dB	≤0.3dB
Enclosure material		aluminium alloy		
Degree of protection		IP20	IP20	IP20
Order Code		D9070	D9071	D9072

SPDs for CCTV CCTV-21

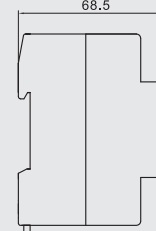
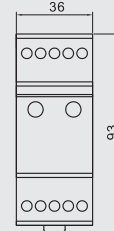
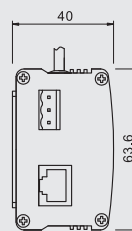
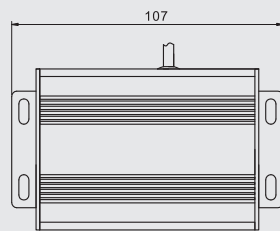
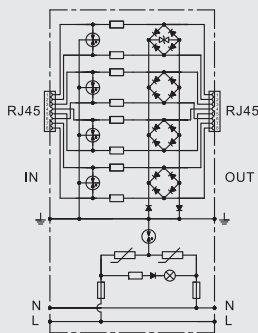
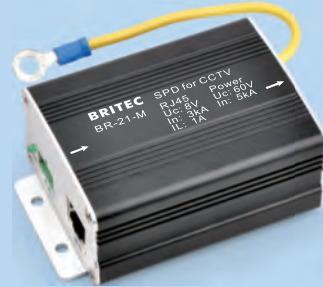

	CCTV-21M-48	CCTV-21M-230	CCTV-21P-48	CCTV-21P-230
Test standards	IEC 61643-21	IEC 61643-21	IEC 61643-21	IEC 61643-21
Max. continuous operating d.c. voltage $(_{RJ45})U_c$	8V	8V	8V	8V
Max. continuous operating a.c. voltage $(_{RJ45})U_c$	5.5V	5.5V	5.5V	5.5V
Max. continuous operating a.c. voltage $(_{power})U_c$	60V	275V	60V	275V
Nominal current IL	1A	1A	1A	1A
C2 Nominal discharge current(8/20 μ s) In	3kA	3kA	3kA	3kA
C2 Max. discharge current(8/20 μ s) I _{max}	10kA	10kA	10kA	10kA
Voltage protection level [line-line/shield] $(_{RJ45})U_p$	$\leq 30V$	$\leq 30V$	$\leq 30V$	$\leq 30V$
Voltage protection level [line/shield-PG] $(_{RJ45})U_p$	$\leq 500V$	$\leq 500V$	$\leq 500V$	$\leq 500V$
Voltage protection level $(_{power})U_p$	$\leq 200V$	$\leq 1.2kV$	$\leq 200V$	$\leq 1.2kV$
Response time [line-line/shield] t _A	$\leq 1ns$	$\leq 1ns$	$\leq 1ns$	$\leq 1ns$
Response time [line/shield-PG] t _A	$\leq 100ns$	$\leq 100ns$	$\leq 100ns$	$\leq 100ns$
Operating temperature range TU	-40°C...+80°C	-40°C...+80°C	-40°C...+80°C	-40°C...+80°C
Connection input/output RJ45/Power	RJ45/Terminal block	RJ45/Terminal block	RJ45/Terminal block	RJ45/Terminal block
Bandwidth	30 Mbps	30 Mbps	30 Mbps	30 Mbps
Insertion Loss	$\leq 0.3dB$	$\leq 0.3dB$	$\leq 0.3dB$	$\leq 0.3dB$
Enclosure material	aluminium alloy	aluminium alloy	Thermoplastic	Thermoplastic
Degree of protection	IP20	IP20	IP20	IP20
Order Code	D9050	D9051	D9052	D9053

www.britecelectric.com



BRITEC

Britec Electric Co., Ltd.

Add: Jing 9 Road, Wei 10 cross, Yueqing Economic Development Zone,
Yueqing, Zhejiang, China

Tel: +86-577-6260 5321

Fax: +86-577-6260 5320

E-mail: britec@britecelectric.com

Website: www.britecelectric.com